

# MAKE YOUR OWN SCULPTING TOOLS

A guide about how to build sculpting  
tools for sculpting in small scales

by  
G. Schellert

revised edition 09/2013

-	<b><u>PREFACE (2009)</u></b>	<b><u>3</u></b>
-	<b><u>SECOND PREFACE (2013)</u></b>	<b><u>4</u></b>
-	<b><u>THE PENCIL TOOL</u></b>	<b><u>5</u></b>
-	<b><u>THE LARGE PENCIL TOOL</u></b>	<b><u>9</u></b>
-	<b><u>MAKING SCULPTING TOOL TIPS: MATERIAL</u></b>	<b><u>11</u></b>
-	<b><u>MAKING SCULPTING TOOL TIPS: TOOLS</u></b>	<b><u>14</u></b>
-	<b><u>MAKING TOOL TIPS FROM 1MM STEEL</u></b>	<b><u>20</u></b>
	- general aspects	20
	- straight needle	22
	- curved needle	24
	- straight edge spatula	26
	- round edge spatula	31
	- straight edge spatula curved / round edge spatula curved	32
	- mini knife tool	33
	- angled spatula	35
	- sculpting knife	36
	- finger tool	38
	- curved burnishing tool	40
	- rivet tool	40
-	<b><u>MAKING TOOL TIPS FROM 1.5, 2 AND 3MM STEEL</u></b>	<b><u>42</u></b>
	- general aspects	42
	- long probe tool	43
	- pointed sculpting knife	45
	- angled cone tool	48
	- diagonally cut tool (eye tool)	51
	- long sculpting knife	52
-	<b><u>POLISHING TOOL TIPS</u></b>	<b><u>53</u></b>
-	<b><u>THE SCHELLERT TOOL - the hard way</u></b>	<b><u>57</u></b>
	- material and tools needed	58
	- how to build the SCHELLERT tool	63
	- an easier way to make the Schellert Tool without cutting threads	70
	- the SCHELLERT-Tool for 1.5 and 2.0 mm tool tips	74
	- the SCHELLERT tool for 3.0 mm tool tips	75
-	<b><u>THE SCHELLERT TOOL - the easy way</u></b>	<b><u>78</u></b>
-	<b><u>TOOL TIP HANDLES</u></b>	<b><u>83</u></b>
	- general aspects	83
	- simple handle version 1	85
	- simple handle version 2	88
	- Schellert standard tool handle	91
	- reducing pieces	99
	- variants of the Schellert standard tool handle	102
	- alternative to the special adjusting ring with socket	108
	- hexagonal aluminium handles	112
-	<b><u>THE MICRO CALIPER</u></b>	<b><u>114</u></b>
-	<b><u>THE SCHELLERT ARMATURE</u></b>	<b><u>121</u></b>
-	<b><u>"FINGER" TOOL FROM A DENTIST PROBE</u></b>	<b><u>129</u></b>
-	<b><u>CONTACT LENSES BOX AS PUTTY STORAGE</u></b>	<b><u>131</u></b>
-	<b><u>SCULPTING TOOL MADE FROM A HOBBY KNIFE BLADE</u></b>	<b><u>132</u></b>
-	<b><u>STAMP TOOLS / PRESS MOULDS</u></b>	<b><u>138</u></b>
-	<b><u>LARGER SCULPTING TOOLS</u></b>	<b><u>144</u></b>
-	<b><u>EXPERIMENTAL TOOLS: MULTI-BLADES</u></b>	<b><u>155</u></b>
-	<b><u>STORING WIP MINIATURES - A SOLUTION</u></b>	<b><u>159</u></b>

## Preface (2009):

The content of this book was originally published in my web blog. For more convenience, I merged all post from the blog into this book.

In this book I will present some ideas and tutorials about sculpting tools and how to build them on your own.

When I say "sculpting tools", I mean those special tools for sculpting Miniatures in very small scales like 30mm or 54mm. So for the "more typical" sculptor, who does stuff in a larger scale, it might be not the most useful book, but maybe there will be also things, that might be interesting for him (or her).

So before I start, some words about my personal view on sculpting miniatures: When I was young (it was in the early 80's) I discovered the game Dungeons and Dragons (maybe there are some people around, that still know it). So short after that I get in contact with those fantasy miniatures that we used in combination with D&D (made by companies Citadel/Games Workshop and Ral Partha for example). I was very fascinated by these miniatures for all their details and so I tried to make my own miniatures. In that time, sculpting miniatures was a very exotic hobby in fact, it still is). I didn't know anyone else personally who did the same thing at this time and there was no internet to search for sculpting fellows.

I made my first miniatures with FIMO, that's a polymer putty, that has to be heated to harden. Then I discovered the two part epoxy-putty Milliput in a shop and did a lot of miniatures with it until someone gave me my first pack of a now famous putty called green stuff, which was a real break-through in sculpting for me.

In the beginning, I made casting moulds with rtv-silicone from my sculpts and cast them in white metal for me and my friends. Later I sold a lot of my sculpted miniatures to a German company called EXCALIBUR, who spin-cast them in white metal and sold them. The company still exists and the funny thing is, that some of my old (and quite crappy, to be honest) miniatures are still in their range.

It was somewhere in the early 90's, when I loose interest in sculpting miniatures for a couple of reasons and I completely forgot about it for more than ten years. Then in 2006 I rediscovered my old hobby and I was fascinated, how much miniature sculpting has evolved since then. Thanks to the internet, there are large communities of sculptors, who share there work and ideas.

So I started again a little bit of sculpting and it was a real nostalgic thing for me, not only because my first new sculpts resemble the characters, that I and my old friends play in our D&D-sessions when we where kids.

When I have a look at miniature sculpting now I sometimes wonder where it might go. Since my early sculpting days, the technology especially regarding to computers, 3d software and rapid prototyping evolved so much, that I ask myself, if in ten years there might be still sculptors, who do their sculpts by hand.

But now there are still a lot of sculpting people around. When I came back to sculpting, I discovered, that despite all those years, that have passed since my first sculpt, it is still

not easy to get the right tools to work with. In fact, the only innovation regarding miniature-sculpting-tools I discovered were the so called clay shapers.

An interesting thing is, that a lot of tools, that claim to be especially dedicated for sculpting miniatures, are -regarding to size and quality- not ideal to tell it in a more friendly way.

There are very few high-quality-tools you can buy, that are especially made for sculpting in small scales. Most of the time sculptors use some kind of dental tools, which is ok for most of the sculpting tasks.

After struggling some times with different tools, I started to make my own sculpting tools to get exactly the tools I need. Because I saw in other blogs and on different forums that "the right sculpting tools" is an interesting point for a lot of people, I decided to start this little Blog to share some of my ideas with the community and hopefully inspire some people to make their own sculpting tools.

So that's what this book is all about. Here you will find here some tutorials on how to do your own sculpting tools.

Comments are very welcome.

You can send an email to [gshellert@aol.com](mailto:gshellert@aol.com)

G. Schellert

=====

## Second Preface (2013)

I made the first version of this ebook in 2009, the year I started my blog about making sculpting tools: [www.sculptingtools.blogspot.de](http://www.sculptingtools.blogspot.de).

Now it is March 2013 and I just updated this ebook by adding the latest tutorials from the blog. I don't know, if I will add much more tutorials, because I think, I wrote down already most of what I can tell about making sculpting tools. I hope I was able to inspire a few people to build their own sculpting tools.

In the first preface from 2009 I wrote about the upcoming of rapid prototyping and the impact it might have on the traditional miniature sculpting. When I look around now, I see that 3d printers are on the rise at already quite low costs. And the quality of those 3d printers is getting better and better. So I'm afraid that I wasn't completely wrong in being afraid that computer and 3d printers will replace the good old school sculpting by hand. That's why I'm not so sure about the worth of this ebook in a few years. At least I hope that the hobby of sculpting miniature traditionally will still exist for a quite long time.

Again: If you have anything in mind that you want to share with me, you can send an email to [gshellert@aol.com](mailto:gshellert@aol.com)

**G.Schellert**  
**Cologne 21.03.2013**

## The Pencil Tool

In this tutorial I will show you how to make a sculpting tool by using a mechanical pencil.

The idea behind that is that you use the mechanical pencil as a holder and instead of the lead you place sculpting tool tips made of 1mm strong spring steel wire into the pencil.

So first you need a mechanical pencil. There are lots of those pencils around. Some of those you can see on pic. 1).



- You should get one which holds leads of an diameter of 0.9 mm (pic. 2).  
If you find one for 1mm leads it would be even better, but I can't find that size.

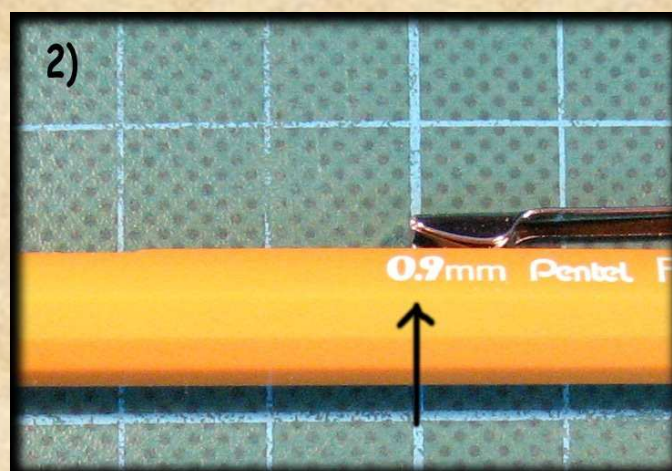

- Inside the pencil is a clamp that holds the lead. Sometime this clamp is made of plastic and sometimes it is made of metal (brass). You should take one with a clamp made of metal (pic. 3).



- The lead-storage inside the pen should be large and the opening under the pushbutton should have a large diameter (pic. 4). That's because later the tooltips, that are not actually in use will be stored here.



- If the pencil has a clip (and most have) the clip should be removable or at least rotatable (pic. 5). Otherwise it might become disruptive when you rotate the tool in the hand.



- The pencil you take should have a strong spring. The harder to push it down, the better it holds the sculpting tip later.

When you found your mechanical pencil, in most cases you have to cut off the tiny little tube at the point of the pencil. Then you have to widen the hole at the point with a 1mm drill. Be careful, not to damage the pencil (Pic. 6). You have to do that because later you have to place tool tips here that have a diameter of 1mm.

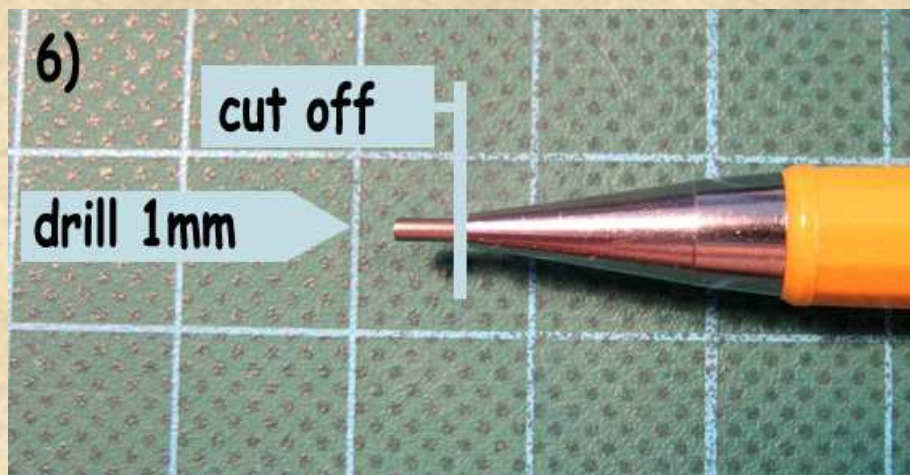

After that, your "sculpting-tool-handle" is complete.

What's left to do now is to place tool-tips inside this holder like those you see on pic. 7). Later I'll tell you how to make such tool tips.

7)

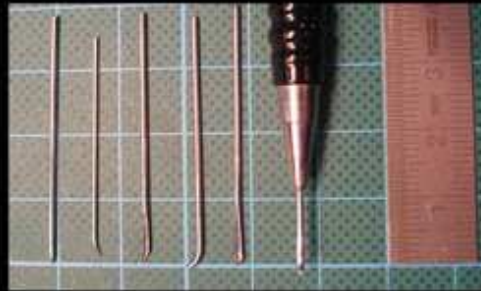
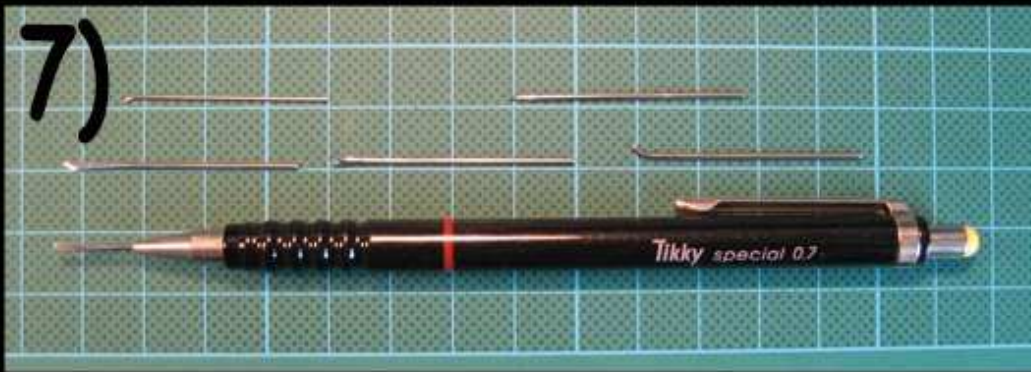



## The Large Pencil Tool

In the last tutorial, I explained how to use a mechanical pencil to make a handle for sculpting tool tips made from 1mm steel wire.

But there are also larger versions of mechanical pencil around that could also be used to make a nice tool tip holder.

On the picture below (pic. 1), you can see one that is made for holding 2mm leads, so this would be fine for tool tips made of 2mm steel wire.

Nothing much to explain here, because you can use this kind of mechanical pencil just as it is without any modification.

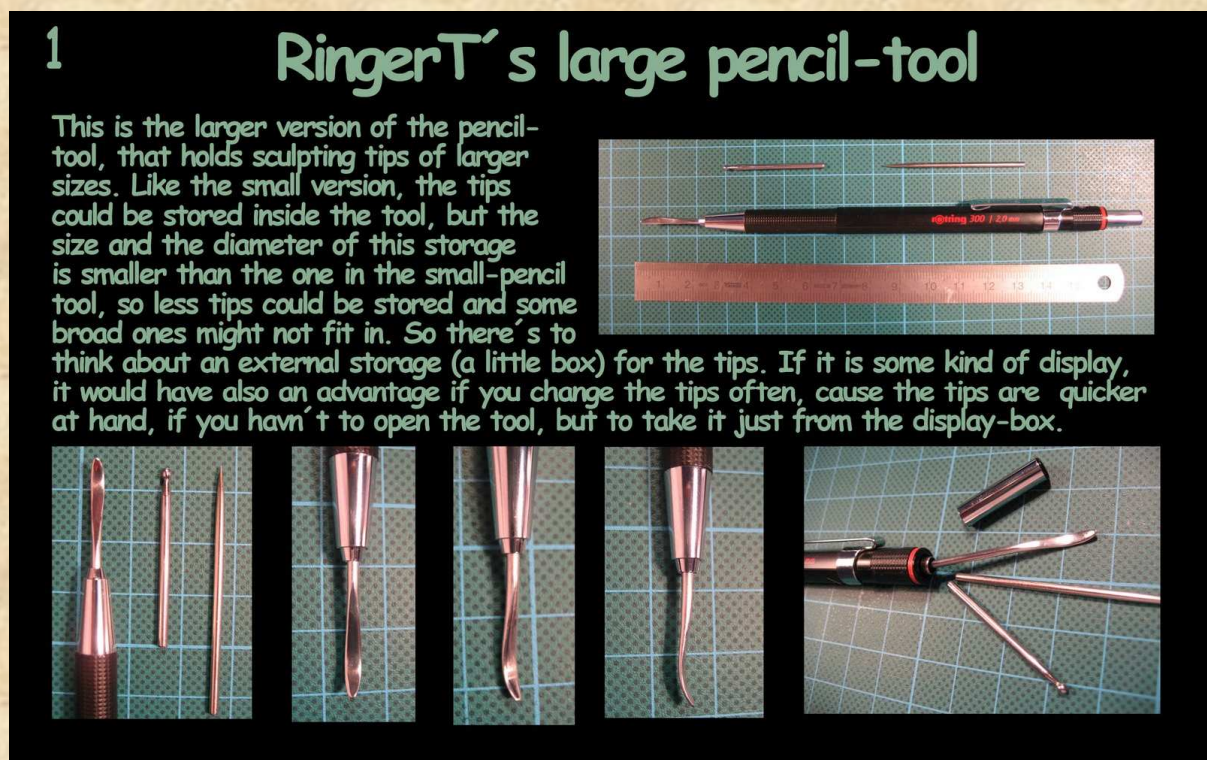

There's another thing, I want to talk about regarding the pencil tools.

Maybe you will come to a point, where you discover, that the grip of the metal clamps inside the pencils didn't hold the sculpting tip tight enough, so it start to rotate some times (see pic. 2).

This might not happen with straight tool tips, but more often with curved or angled ones.

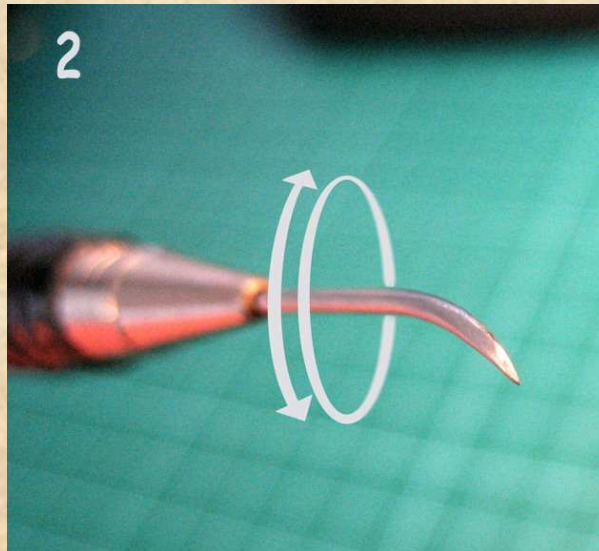

If this happens, you can modify the back ends of your tool tips a little bit. Most of the pencil clamps are made of three parts (jaws) like you see in pic. 3.

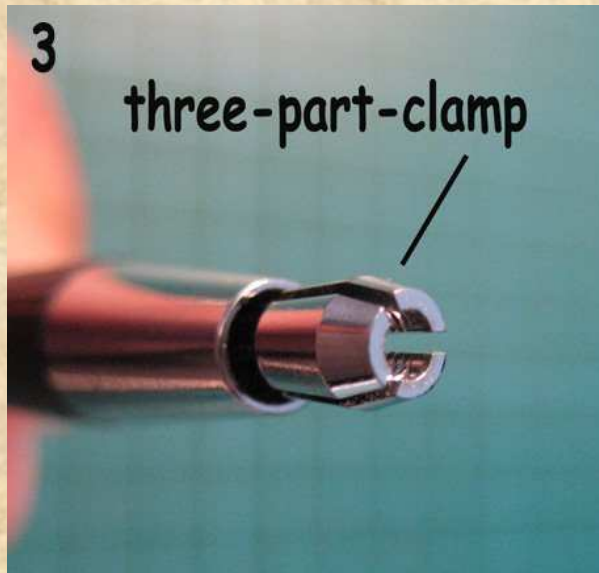

So just file or grind down the back end of your tool tip, until it gets a slightly triangular shape (pic. 4). In most cases, that should solve the "rotating-problem", but I have to admit, that this rotating thing is a weak point of the pencil tools.

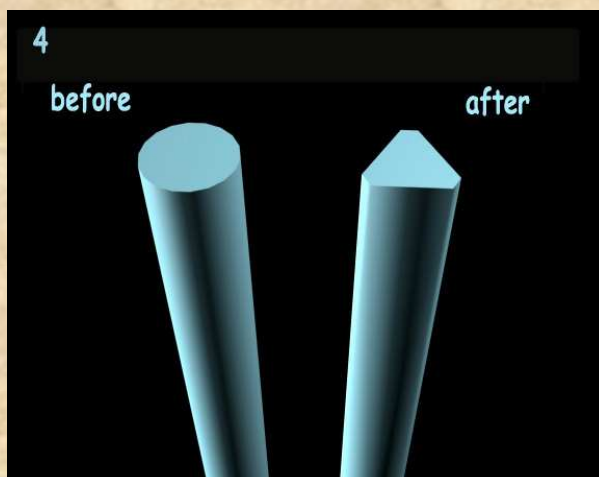

## Making Sculpting Tool Tips: MATERIAL

In this tutorial I start to explain, how to make sculpting tool tips from metal.

In the last tutorial I explained the sculpting tool that I called Pencil-Tool. For that pencil-tool you will need tool tips that are made of steel wire with a 1mm diameter to fit into the tool. But in this tutorial I will not only explain how to do such sculpting tips from 1mm steel wire, but also how to do tool tips from steel wire with a larger diameter.

In addition to that, in the coming tutorials I will show you how to build holders or handles for those larger tool tips too.

Maybe you will make your own experience with material and material sizes while building your own tools and maybe you will find a better way than explained by me. That would be great and if so, please let me know. I don't claim to have the one and only way to make this stuff. I just want to explain, how I did it.

That said, I basically would recommend sculpting tool tips made from steel wire with four different diameters. These are:

**1 mm,**  
**1,5 (or 1,6) mm,**  
**2 mm,**  
**3 mm**

I always use steel wire with a round diameter. Sometimes you can also find steel wire with a square diameter, but I never used it.

Maybe here starts the first little problem. Even if I try to write this blog in English, to address it to a larger audience, I 'm from Germany. In Germany we have a metrical system that measures in meters, centimetres and millimetres. I guess, in the US, in Great Britain and some other countries, there is another system of sizes (inches and so on).

So I'm not sure, if in those countries, it would be easy to find steel wire that is sized in millimetres (maybe eBay could help). If not, you should try to adapt my tutorials to steel wire that you can find in your homeland. It should not be too difficult.

Until now, I always said "steel wire".

Now I want to explain exactly what I mean with "steel wire". The steel wire used to make sculpting tool tips should be strong, so it will not bend while sculpting with it. On the other hand, it has to be workable, that means, it has to be flexible and formable to a certain degree. Otherwise you will not be able to form a special-shaped tooltip from it.

### **FOR 1MM and 1,5 MM USE SPRING STEEL**

So for the tool tips made of 1mm and 1,5 -1,6 mm Steel wire I recommend the use of so called spring steel. At least the word "spring steel" is a translation of the German word "Federstahl". I do not know if this is the correct word in England / the US. I mean this quite hard and elastic kind of steel that is used for all kind of springs because it "springs" back into form when you bend it. This kind of

steel is a little harder to work with, but it has the strength to keep tool tips with such small diameters in form while sculpting.

You have to know, that spring steel is not stainless! That may sound like a problem, but in fact it is not. At least I never had a problem with that. You have to be sure to polish the tool tips to a high degree finish (more about that in a later tutorial). If you do that and if you dry your tools before storing them, it would be highly unlikely that your tools will catch some stain. There are some additional things to keep in mind when forging spring steel. I will tell you more about that later, when it comes to forging.

### **FOR 2MM AND 3MM USE V2A OR V4A STEEL**

For the larger tools made of steel wire with larger diameters, so the 2mm or 3mm you could also use spring steel. But because spring steel is hard to work with, especially when the wire has a larger diameter, I recommend the use of V2A or V4A steel. That is a kind of stainless steel. This steel is quite easy to flatten with hammer and anvil and of course it is stainless. But on the other hand it is not as strong as spring steel, so you might run into problems, if the final tool tip is too thin, because then it could bend. If this should be the case and if you cannot make the desired tool tip thicker, you should take spring steel for that special tool tip. Generally you should not have any problems with 3 mm V2A or V4A steel wire because this is strong enough. With the 2mm wire it depends more on the shape of your tool tip. But with the tool tips, that I will show you in the coming tutorials, you will not have problems with that.

### **WHERE TO FIND THOSE STEEL WIRES?**

So now you know, what you need, where to find it?

Spring Steel can often be found in hobby- and model craft shops. Maybe you should Google for it and also eBay might help.

V2A or V4A steel wire or steel rods can often be found in building centres, hardware stores and do-it-yourself-stores. You can use those steel rods that are used for welding. But be sure not to take those used for welding aluminium because that's not steel.

### **SPECIAL HINT FOR 1MM WIRE: SAFETY PIN**

For the 1 mm wire, I have a very fine alternative for you. Instead of searching for spring steel you can use the steel from safety pins. For that you need safety pins with the right size. I found out, that those with a length of 50 mm will do best for me (pic. 1). I don't know exactly, what kind of steel these safety pins are made of, but the characteristics of that steel is like spring steel, but it's a little bit easier to work with. Maybe you will have to try some different safety pins and have to find out, which one are long enough and has the right diameter for your needs. And I guess, not all are made of the same sort of steel, so you have to try to find the best.



Cut the safety pin in the middle of its spring, like you see on pic. 2. While doing that, you will get two parts of the safety pin, each with one curved end. This end -while being cut off later- is useful to hold the wire in the hand while forging it. So don't cut it off now. Then you have to remove the metal-sheet-part of the safety pin with a fine forceps or pliers. This is a little tricky. Take care not to hurt yourself.

After that you will have left two wire parts, one with a pointed tip and the other one with a bent tip. You can cut off the bent part of the one piece unless you want to make a sculpting tip with a bent tip (like a curved spatula for example). The same applies to the pointed end of the other piece. You can cut it off or leave it as a starting point for making a straight-needle- or curved-needle-tip (pic. 2).

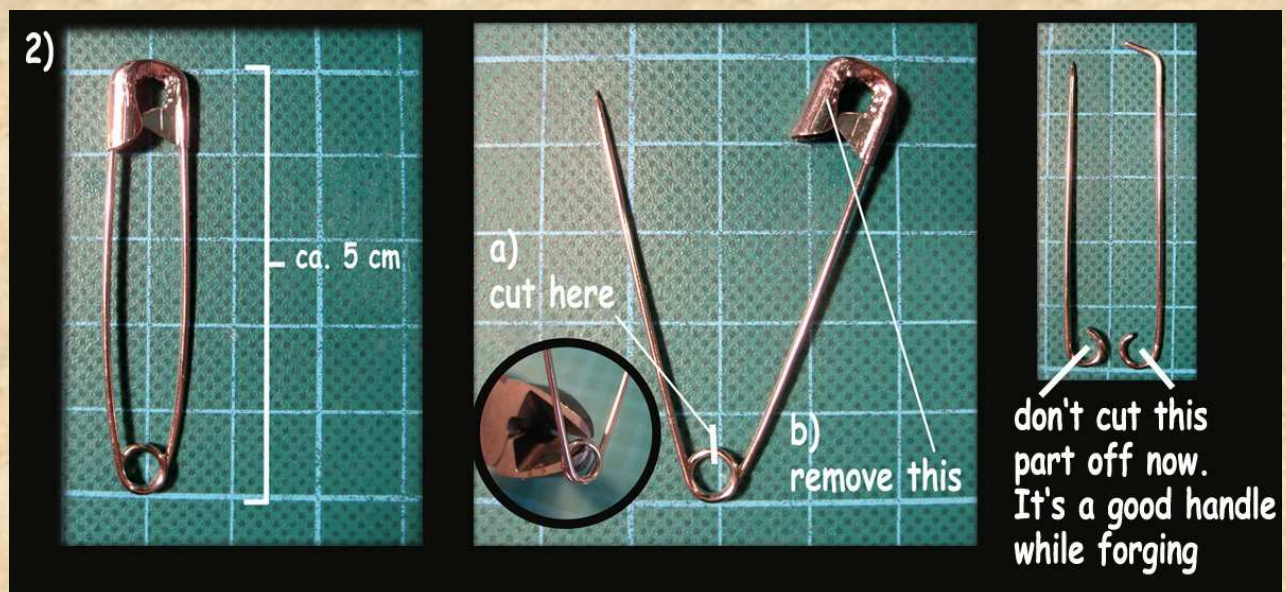

In the next part, I will tell you, which tools you need to forge the sculpting tips and which tools might be helpful.

## Making Sculpting Tool Tips: TOOLS

Today I will discuss the tools that you will need to forge the sculpting tool tips. You don't have to be a metallurgist to do this, but some tools are definitely needed and others are at least very useful.

### HAMMER

Something you definitely need is hammer and anvil. Most of the time I use two different hammers, a 100g and a 200g hammer (pic. 1). On the 200g hammer I rounded the edges of the hammer head, because I read that advice in a book about forging knife blades. This is something you surely don't have to do necessarily. Just in the case your hammer has a little bit sharp edges, grind it down a little bit to avoid leaving marks on the steel wire when forging it. For some work, especially for forging 3mm Steel wire, you might also find a heavier hammer like 400g or even heavier useful. When you do the forging of 3mm steel wire without heating it up (more about that later) you will surely need such a heavy Hammer. But to tell it right here: I personally didn't use 3mm steel wire very often. The reason is that with that diameter, you will make quite large sculpting tool tips and I still have enough of such larger tools like dentist tools. So personally I concentrate more on the smaller sculpting tips made with diameters of up to 2mm. For that the two lighter hammers (100g and 200g) are ok, if you heat the steel wire up before forging it.

### ANVIL

You also need an anvil because you have to place the wire on a strong surface that can stand the blows from the hammer. Your desk isn't ideal for that (believe me).

Of course you don't need necessarily a typical anvil like on pic. 1). You can also use an anvil plate that often can be found on a bench vice (see pic.2) but be sure, that it is strong enough.





This is also  
a kind of anvil  
you can work on

I use the two anvils that you see on pic. 1). On the small one I only use the cone like end to give the small tool tips a curved shape if needed.

### **GAS TORCH**

What you also need is a gas torch to heat up the steel wire.

In the beginning I used a little gas torch, that my wife uses to make crème brullée (pic. 3)



But its flame was a little too small and my wife wasn't amused to see me using her kitchen stuff that way. So I went to the hardware store and bought the simple gas torch, you can see on pic. 4).



As I mentioned before, it's possible to forge the steel wire without heating it up. At least the V2A, V4A steel could be cold-formed that way, just by beating it with the hammer. With spring steel this would not work, because it's too hard. I recommend heating up every kind of steel, you want to forge, because then it's easier to get it into shape. If you don't heat it up, you'll need much more power (and a stronger anvil) and that might result in some lack of preciseness because it's difficult to hit hard and precise at the same time. But to be fair at this point I have to tell you, that I know someone who is a well known sculptor and who uses 3mm steel wire for all his tools and never uses heat to forge them. So maybe you should also try this way when you've got a little experience.

#### **ABRASIVE PAPER**

What you also need is abrasive paper (sand paper). You will need that to grind the pre forged tool tips down and to give them a good surface before polishing them. There are grinding papers with different grind sizes. Be sure to take the one for metal (and not the one only for wood).

And you should get a selection of papers from rougher to finer grain sizes (pic. 5).





## ABRASIVE PADS

A very good aid and addition to abrasive paper are abrasive (grinding) pads and blocks (pic 6).

These are made of some kind of foam rubber, covered with a kind of grinding sand. Because these pads and blocks are flexible, it's much easier to achieve a rounded surface on a sculpting tool tip. So if you can find them, you should get some of this. The finest of those pads make a surface of nearly polished quality. For the pads, take the thinner ones that are only sand-covered on one side because they are harder. The two-sided pads are too soft. The blocks are hard anyway. If I tell you in the later tutorials to use abrasive paper I also mean the use of these grinding pads.



## ROTARY TOOL

What makes the work much easier is a rotary tool like from Dremel or Proxxon (pic. 7). For that you should get some grinding stones and cutting wheels (pic. 8a). With such a tool, it's easier to grind down your pre forged tool tip into shape. Also you will do the polishing work with it (pic. 8b).





### **SAFETY GLASSES (GOOGLES)**

That's no joke and you should take this point serious. You have to get a pair of safety glasses and wear it while forging and while working with machines, especially a rotary tool. A cut in the hand might cure easily, a cut in the eye will not.



## OTHER TOOLS

There are some other tools that might be useful if you already have them or if you can get them cheap. Especially machines to grind down stuff are useful. On pic. 10a-c) you can see some of these tools.

Pic. 10a) and pic 10b) are belt grinding machines, pic 10c) is an electrical grinding stone



But even, they are useful, they are not essential.

## POWER DRILL

Also an electrical drilling machine (power drill) will be useful, if used with a grinding stone instead of a drill. But always be sure to respect the safety aspects. Be sure, the machine is fixed safely when using it (pic. 11).



That's all about tools so far.  
So next time we'll start forging the first tool tips.

## Making 1mm Sculpting Tool Tips

### GENERAL ASPECTS:

While I talked about materials and tools in the last blog entries, it's now time to explain how to make the different tool tips. I will start with tool tips made of 1mm steel wire.

As you can imagine, there are thousand of possible tool tip shapes that could be made and I don't want to bore you with all that, so I will just explain the few tool tip shapes that I did for myself and that I found useful. I start with simple ones and getting then to the more complicated ones.

All the tool tips I made have a length of about 4 cm. I found this length fits best to my needs, but you might found out, that a shorter or longer version would be better for you. If you are not sure about the right length, do it like me with 4 cm or leave it a little longer. It's always possible to shorten the tool tip later, but not to lengthen it.

The typical attribute of all tool tips is that they have the forged tip only on one side, while the other side fits into the tool handle.

You can imagine that forging a 4 cm steel rod with hammer and anvil didn't leave a lot of space between the hand that holds the steel and the hammer.

So I found out, that it's much easier to take a steel rod with a length of about 8 cm and forge a tool tip on each side before cutting the rod in the middle like you see on pic. 1). The example shown on pic. 1) is made of 2mm steel.

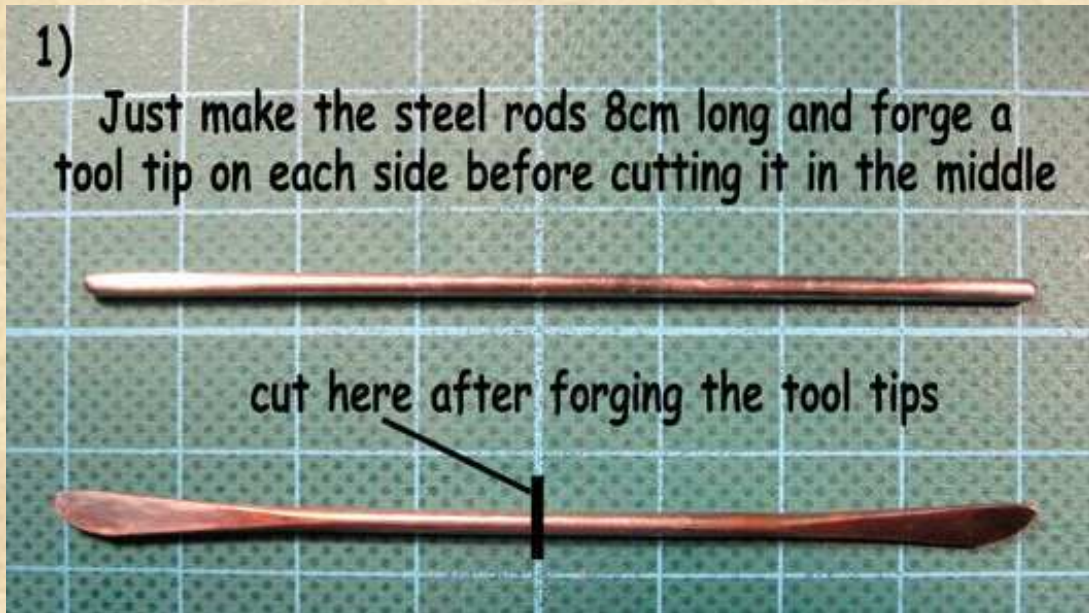

Another thing that belongs to all tool tips, regardless if made of 1mm, 1,5mm, 2mm, or 3mm is how to treat the back-side of the tool tips, I mean the side that fits into the handle. I recommend, to

1. Clean the cut and
2. Give this end of the tool tip a round or cone like shape.

You can do this best and easiest by using the rotary tool with a cutting wheel. Instead of cutting, you use the wheel as a grinding disc, by pressing the tool tip very lightly on this disc, while rotating the rod between your fingers into the opposite direction to the rotating direction of the rotary tool (see pic. 2).

Please be careful and don't press too much on the rotating disc, because they are quite delicate and break easily. And be sure to always wear safety glasses.

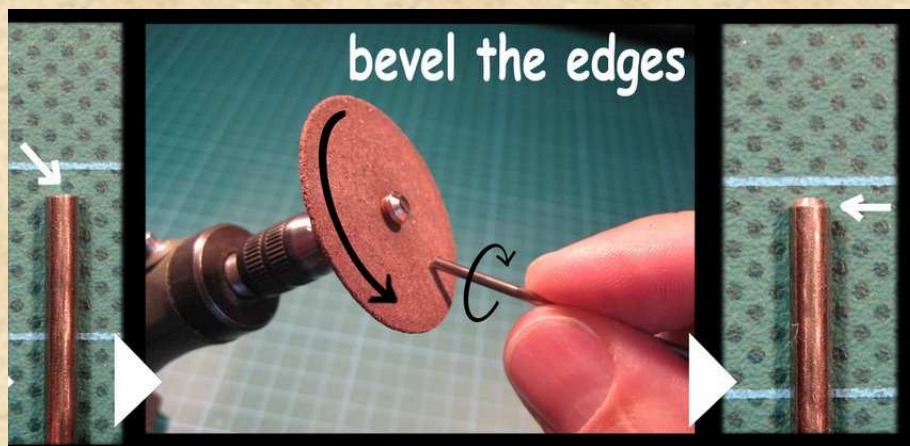

I recommend that because it makes sure, that you won't have any sharp edges left and it helps to change the tool tips in the handle because it's easier to fit the tool tip into the handle.

Ok, now it's enough with pre-talk. So let's start with the most simple tool tip, the straight needle tool tip.

### **THE STRAIGHT NEEDLE TOOL TIP**

This is very simple to do and in fact you don't even have to use hammer and anvil. As I said before, you have to use spring steel wire for the 1mm tool tips. All you have to do is to give your spring steel rod a needle like tip. You can do this with the rotary tool and the cutting wheel like I've explained before in regards to the backside of the tool tip (see pic. 2). Even easier and more precise is to use instead of your hand that rotates the steel rod a second rotary tool, if you got one.

If you just got only one rotary tool, you can also place the steel rod into the rotary tool and use some kind of grinding stone or even a band grinder to give your steel rod a needle like shape (pic. 3).

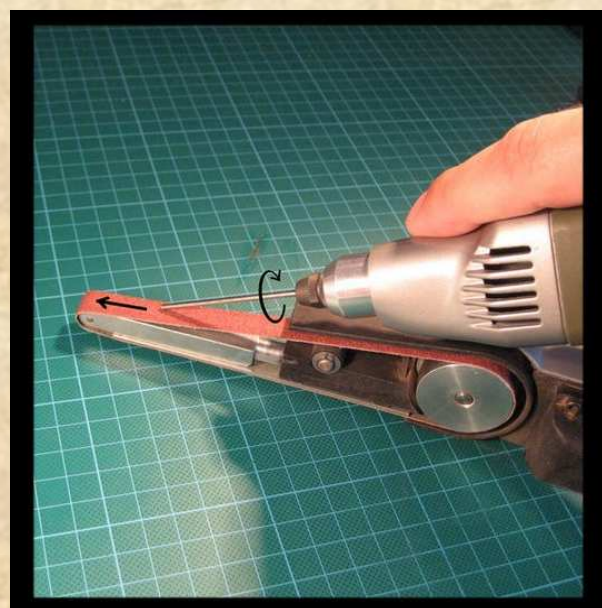
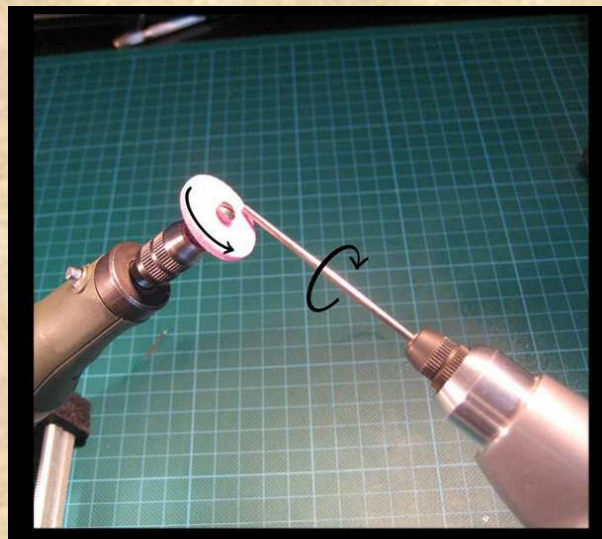
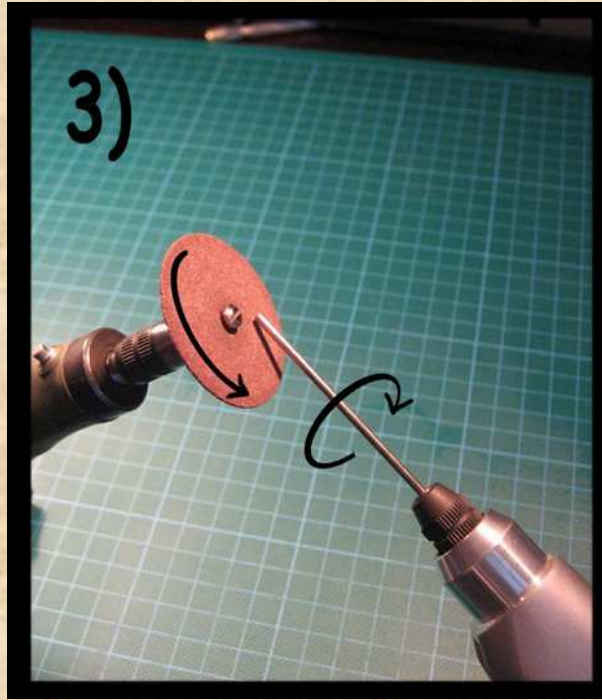

After your basic shape of the needle tip is ok, you have to give it a smooth surface by using the abrasive paper. Work from coarse grain to finer grain until the surface is free of all scratches. It's easy to achieve this by dragging the rotating steel rod (in the rotary tool) in an angle over the abrasive paper (or the abrasive pads, if you got them).



If you use the steel taken from a safety pin (See the blog entry about: Material) you are lucky, because all you have to do is to take the pointed part of the safety pin and cut off the rounded end at the right length. Just clean the cut (see above) and you are done. In most cases you don't even need to polish the needle tip taken from a safety pin, because usually it already is.

Otherwise, you have to polish your tool tip at last. Because this applies to all tool tips, I tell you later, how to do this.

That's it: Your first tool tip is done. So let's go on to a very useful variant of the straight needle tool tip: the curved needle tool tip.

### **THE CURVED NEEDLE TOOL TIP**

The next tool tip is just a modification of the needle tool tip, I've explained above. So first you need a needle tip like I explained before. Then you have to heat the pointed tip up by holding it over the flame of your gas torch. When it glows red take your lightest hammer and forge the tip carefully to one side by using the cone like end of the small jewellers-anvil. Be careful and make sure, that you just bend the steel but not flatten it.

You can also try this without heating the steel. Sometimes this works.

As an alternative to hammer and anvil, you can also try to bend the pointed tip with special pliers that are used to bent wire into round shapes. You can also try this without heating, but bending it with pliers is a little tricky, so you will have to practice a little bit (see pic. 5). Bending the steel taken from a safety pin would be easier than bending the conventional spring steel.



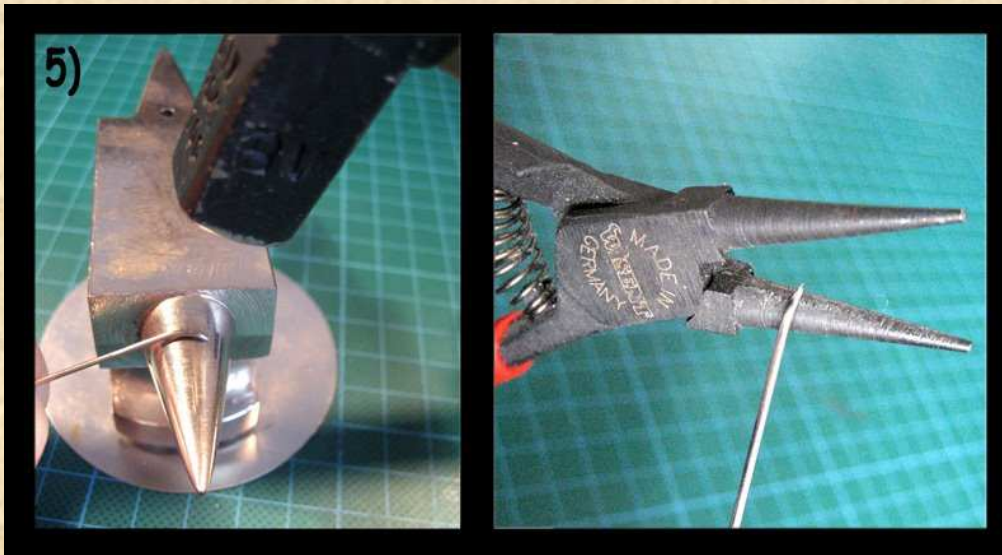

You could end here and just use this tip as it is, but I recommend the following:

This tool tip is even more useful, when you "sharpen" the outside of the rounded tip like a reversed "V". Its a little bit hard to explain, but you should drag the outer side of the rounded tip over fine abrasive paper on both sides as if you would like to sharpen a knife blade. BUT don't give it a real sharp edge. The outer edge should still be rounded, but just a little thinner as before. In the following pic. 6) I try to show that a little bit clearer.

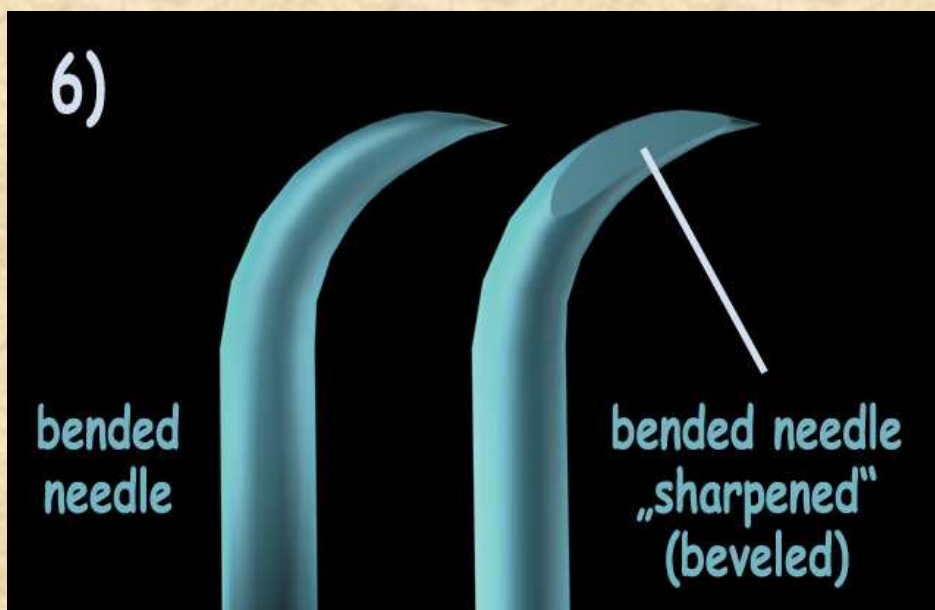

After that you just have to refine the surface of the tip and to polish it.

To tell the truth, the idea for that kind of tool tip is not mine. I saw that first on an illustration that Tom Meier did to explain on a forum the tools he uses.

For me, this tool tip is great for very fine and delicate work, like faces for example. It's like a needle, but because of the slightly sharpened edge also like a spatula. With it you can push the putty to the right place and you can also blend to layers of putty together

even in very small areas. So just try this tool tip out. If you get to use it, it's a really great tool.

## **SPATULAS**

The next tool tips, I would like to explain, are spatula like tool tips in some variants.

### **THE STRAIGHT EDGE SPATULA TOOL TIP**

To make the straight edge spatula tip, you have to take one of your 1 mm spring steel wire rods.

Remember that it might easier if you take an 8 cm long piece so you can hold it better in your hand while forging.

Alternatively (or if you use the steel taken from a safety pin) you can fix your spring steel rod into a pin vice (pic. 8)

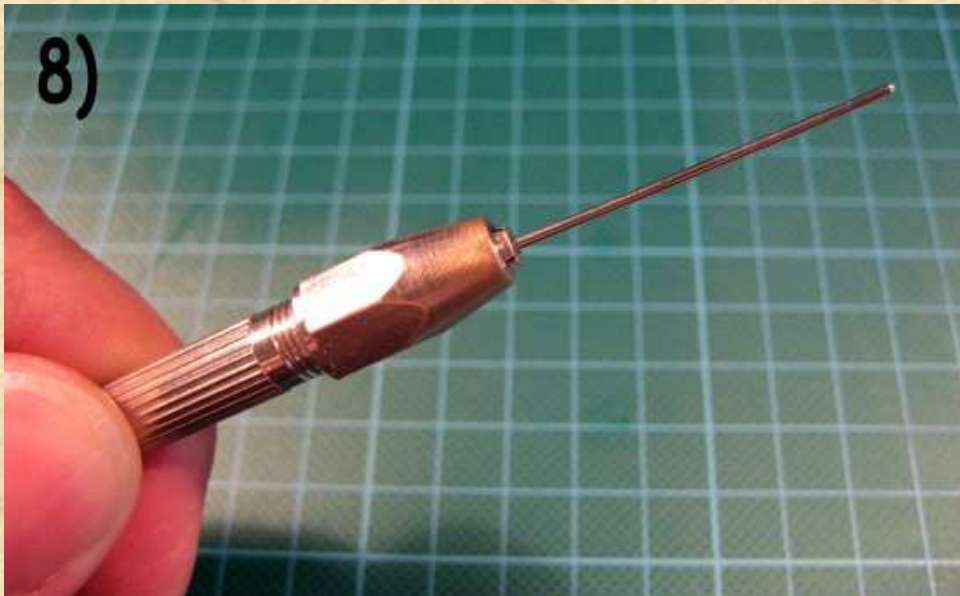

Before you start forging this steel rod, make sure, that the endpoints (were you cut the steel) are clean and flat.

With flat, I mean, not rounded or pointed.

You can achieve this best by grinding the end of the rod in a 90-degree angle with the cutting wheel on the rotary tool like you can see on pic. 9).



If you got your steel rod prepared, it's time for forging. For that, hold your steel rod with the prepared end over the flame of your gas torch until it glows red. Then lay it on the anvil and flatten it by hitting with the hammer from straight above on the glowing end.

For forging 1 mm steel, I always use the 100g Hammer, but you should try for yourself, what's best for you.

Because the steel rod is quite thin, it didn't hold the heat and the glowing very long. In fact it will be only a few seconds, especially if you lay it on the cold anvil.

So you have to be fast to forge it, but don't get into hectic pace. Preciseness is far more important than speed. If the metal gets too cold, just heat it up again with the gas torch.

Even I said, you have to be quite fast, don't try to do too much forging in one turn.

Also important is that you'll hit the metal equally on both sides. So when laying the steel rod on the anvil, I recommend to hit it for about five times, than turn it on 180-degree and give the other side (the side that lay on the anvil before) another five hits.

Then stop hitting and heat the metal up again and start again until the steel is flat enough at the end.

It's important to work (hit) both sides of the "tool tip" to keep it symmetrical (pic. 10)

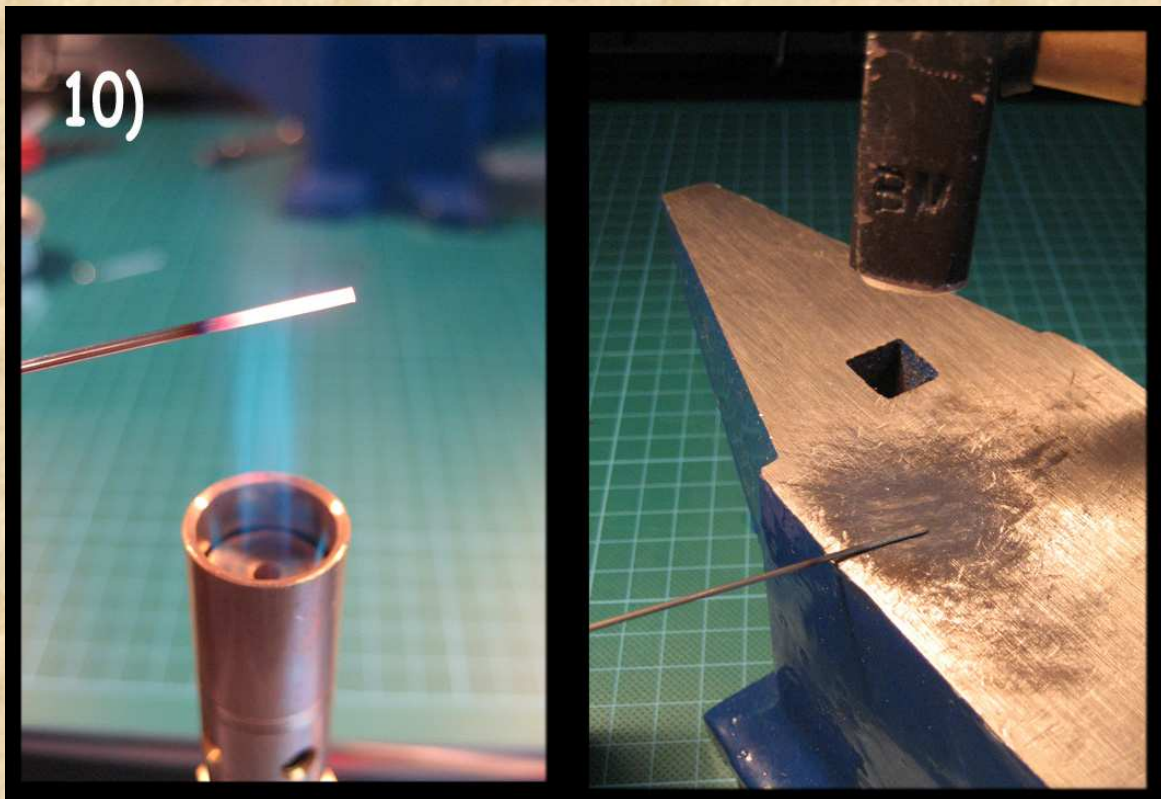

Some hints about forging spring steel wire:

When you forge spring steel by heating it up and hitting it with the Hammer you will discover, that the forged surface of the steel is not plane, but rough with some little holes and dints.

That's because of the way spring steel reacts on such a treatment.

When you heat up the spring steel, some particles of the steel burn off, especially when you hit the glowing steel with a hammer.

This is quite normal and can' be avoided (at least not for you and me working at home).

In pic. 11) you can see the difference between a freshly forged 2mm-steel rod and the same after cleaning up the surface with abrasive paper.

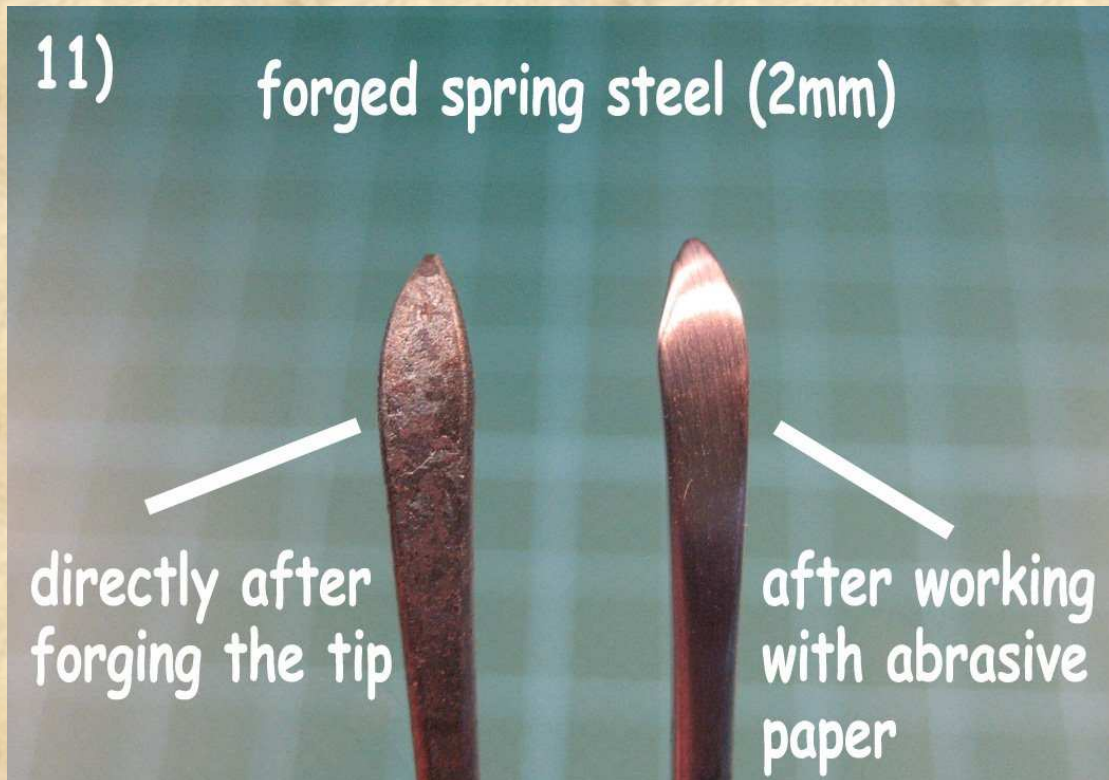

So this material issue leads to two recommendations:

1. Don't "overheat" the steel and don't heat it up too often.
2. Don't flatten the steel too much, because you need to have some material left for grinding down the tool tip to remove the holes and dints and to give it an even surface.

Another thing with spring steel wire is that sometimes it is quite brittle after you've forged it.

So don't try to bend a tooltip, that is forged hard (like the spatulas) with pliers without heating it up. Your steel might break then. (It might even break, if you heat it up before).

After some forging your tool should look like on pic. 12).

Now you can refine the shape a little bit with the rotary tool and the cutting wheel (or other grinding tools on the rotary tool).

After that, grab your abrasive paper and drag your spatula over it to get a smooth and even surface.

Again start with rougher abrasive paper and go on to finer one. Go on with this grinding until there are no holes, dints and scratches on your tool anymore.

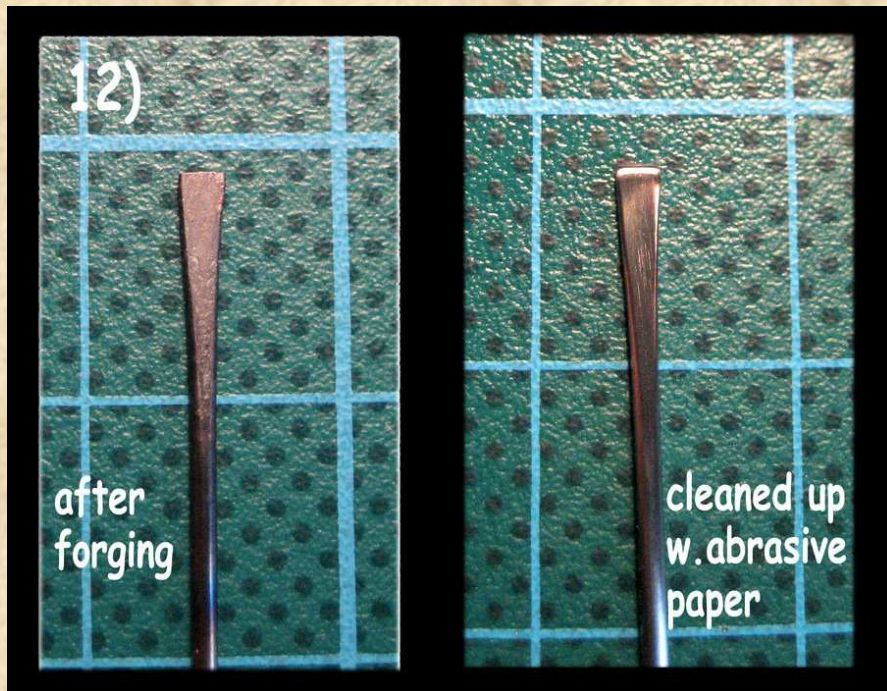

There are two alternatives for the flat sides of this spatula tool. You can leave the flat sides really "flat" with a sharper edge or you can give it a slightly round surface (see pic. 13). It's easier to get a rounded surface if you use the abrasive pads in addition to the abrasive paper. Both versions, "flat" and "rounded" have their advantages, so you should try both. Of course you can have both in one spatula: give one of the sides a flat surface and the other one a more rounded one.

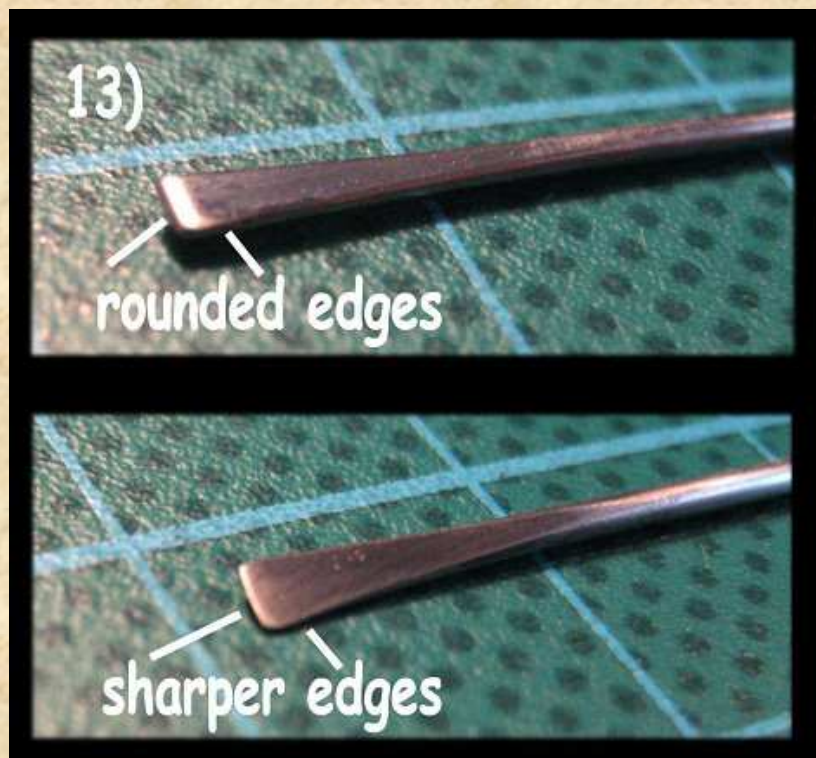

All that's left now is to cut your tool tip to the right length, refine the cut end like explained above and polish your tool tip (more about polishing later).  
Ta-dah... Your first forged tool tip is done.

**ROUNDED EDGE SPATULA TOOL TIP:**

The next spatula variant is nearly the same as the one above, except one little thing. This time you have to prepare your rod in a different way before you start forging. This time you give the rod not a clear, straight 90-degree cut end, but a rounded one like you see on pic. 14.

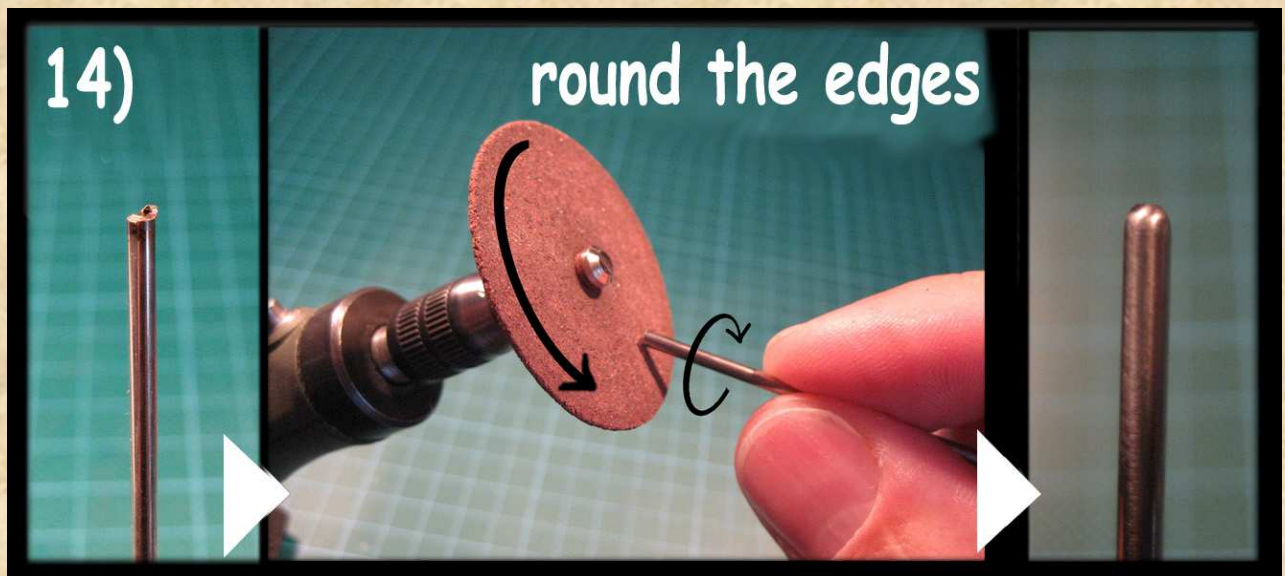

Again, it's quite easy to achieve this rounded end with the rotary tool and the cutting wheel. Be sure to rotate the rod slightly between your fingers while holding it onto the cutting wheel. You could also use just abrasive paper for that, but it's much more work and it's harder to achieve a "clean" rounded shape.

If you got the rounded shape on the end of your steel rod the rest of the work is exactly like explained for the straight edge spatula tool tip above.

After forging the spring steel, your tool tip should look like on pic. 15. Again you have to work on the surface to remove the scratches and hammer marks before polishing it.

Like on the tool tip above, you can give the flat sides on your tool a really sharp edged flat surface or a more rounded one or (that's what I recommend) make one side "flat" and the other more rounded.

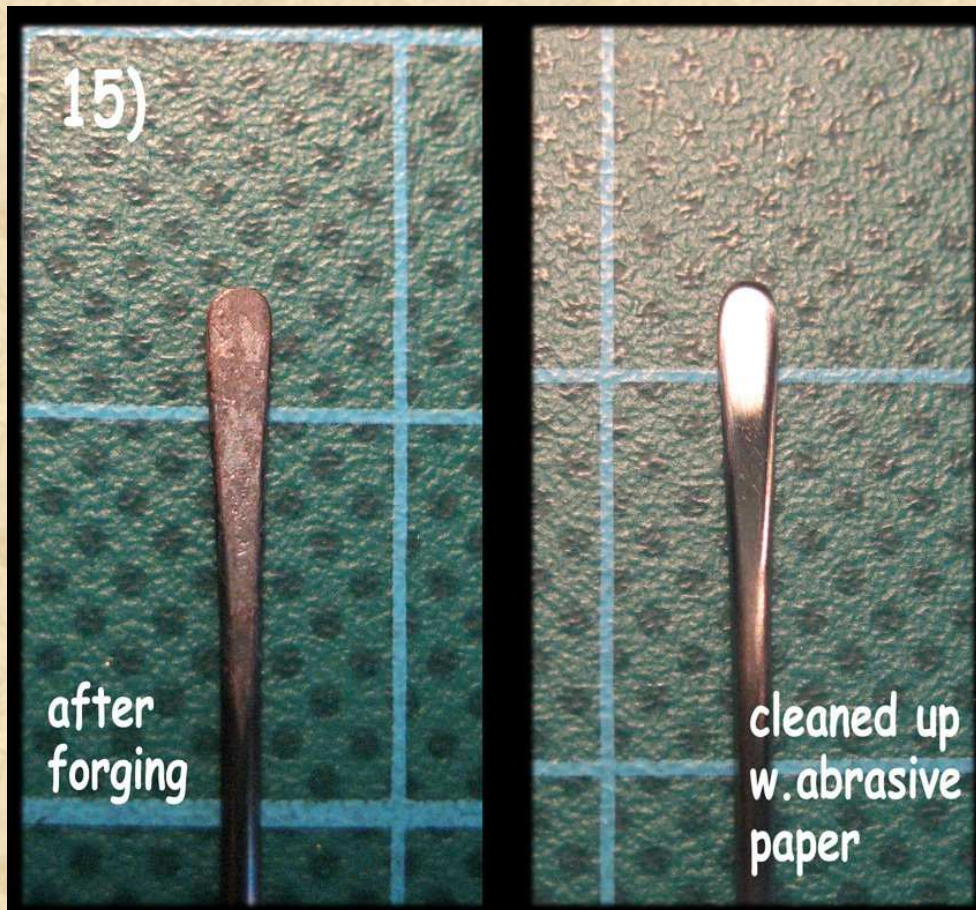

You see the difference between this tool tip and the one explained before is just the rounded edge at the top instead of the straight edge on the tool tip before. This difference may look small, but while sculpting it makes a big difference.

### **STRAIGHT EDGE SPATULA -CURVED / ROUND EDGE SPATULA - CURVED**

There is another variant for both of the spatula tool tips, I've explained before.

To start you need the two spatula tool tips I explained above as bases. Then you just have to "bend" them a little bit so the tip is no longer straight but rounded like you can see on pic. 16.

As I mentioned before, don't try to bend the spatulas with pliers while they are cold. They will break. Just do the "bending" with heating up the tool tip and use the hammer to carefully bend the tip on the cone-like end of the micro-anvil or the edge of a larger anvil.

You can also try to bend the tool tip with pliers when it's hot, but as I said above: It's a bit tricky and the tooltip is delicate now, so don't get frustrated when a tool tip breaks.

That happens sometimes, so if it happens, see it as something on your "experience-account".



If you get it, your tool tips should look like on pic. 16.

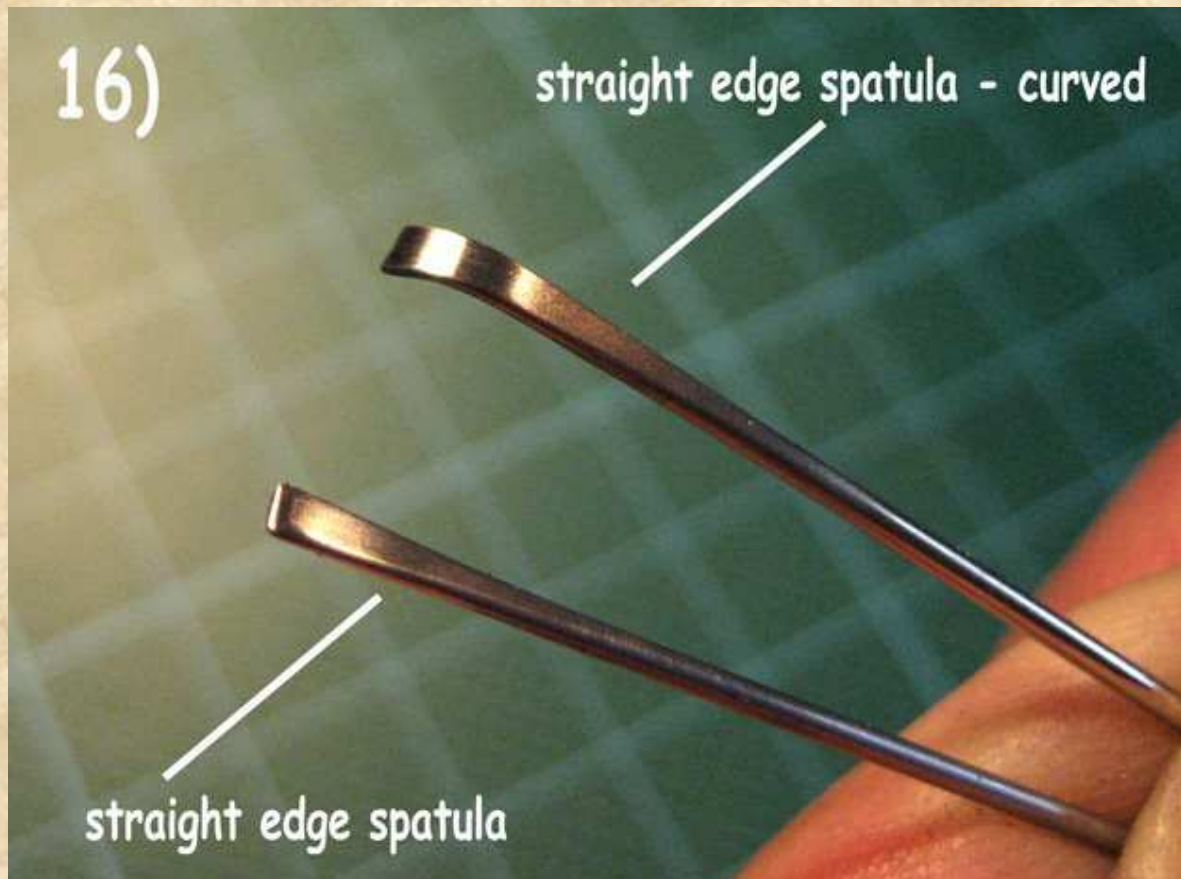

These curved variants of the spatula tips could be really useful in some sculpting situations.

### **THE MINI KNIFE TOOL TIP**

The next tool tip I call the mini knife tool tip because that's just what it is.

If you already made a straight edge spatula tool tip, this tool tip will be quite easy for you to build.

You have to forge the spring steel rod as if you would build a straight edge spatula tool tip. Then you have to cut off a bit of the flat end of the flattened steel like you can see on pic. 17).

You can just grind away the steel with the rotary tool and the cutting wheel or you can cut it off with nipper pliers or pincers and then refine the edge on the cutting wheel (which might be easier).

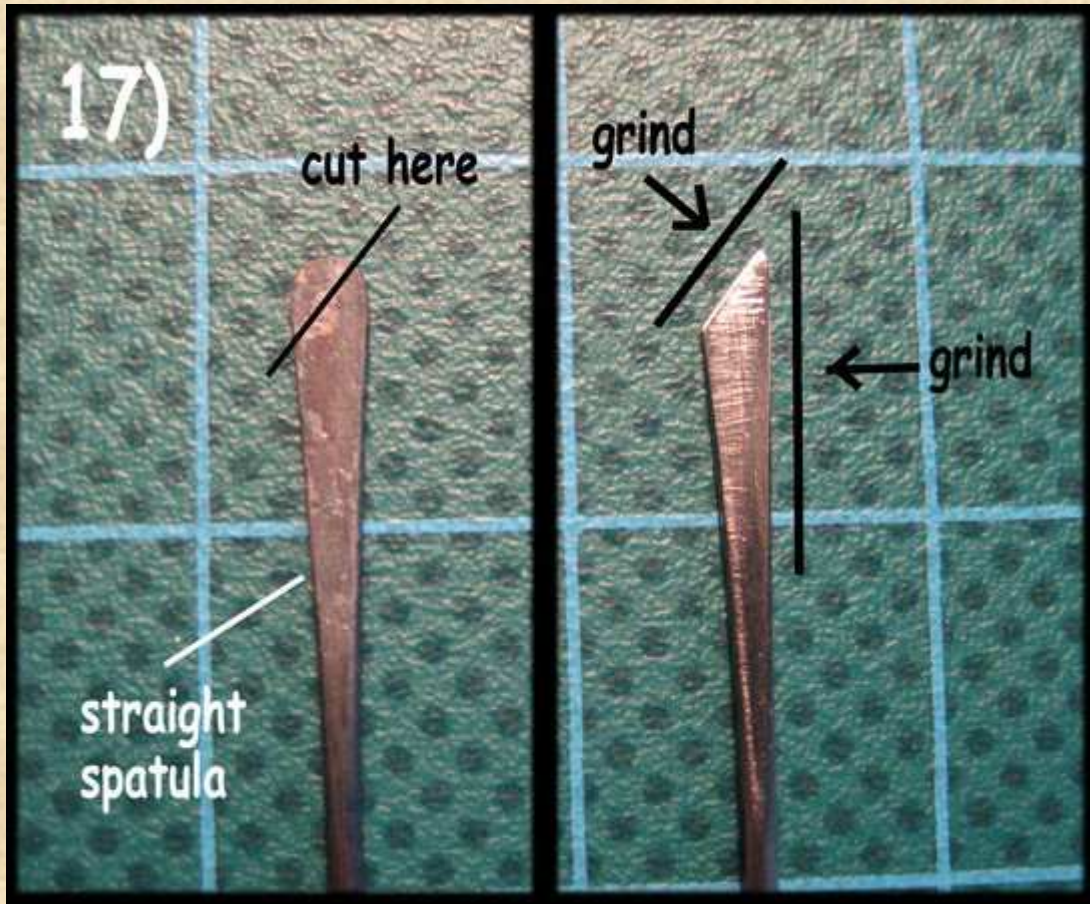

After that just make sure, to get a smooth surface on your tool tip without scratches by using the abrasive paper like I've explained before. If you are pleased with the surface, all that's left to do is to sharpen the edge of this mini knife. To do this, press the knife tip along its edge on abrasive paper with a fine grind in a 45-degree angle. Then drag it in a direction of 90-degrees to the direction of the edge, like you can see on pic. 18).

This might sound a bit complicated because it's not easy to explain it exactly but simple at the same time and because of the lack of my English (sorry for that). But it's exactly the same thing as if you would sharpen a (real) knife on a sharpening stone.

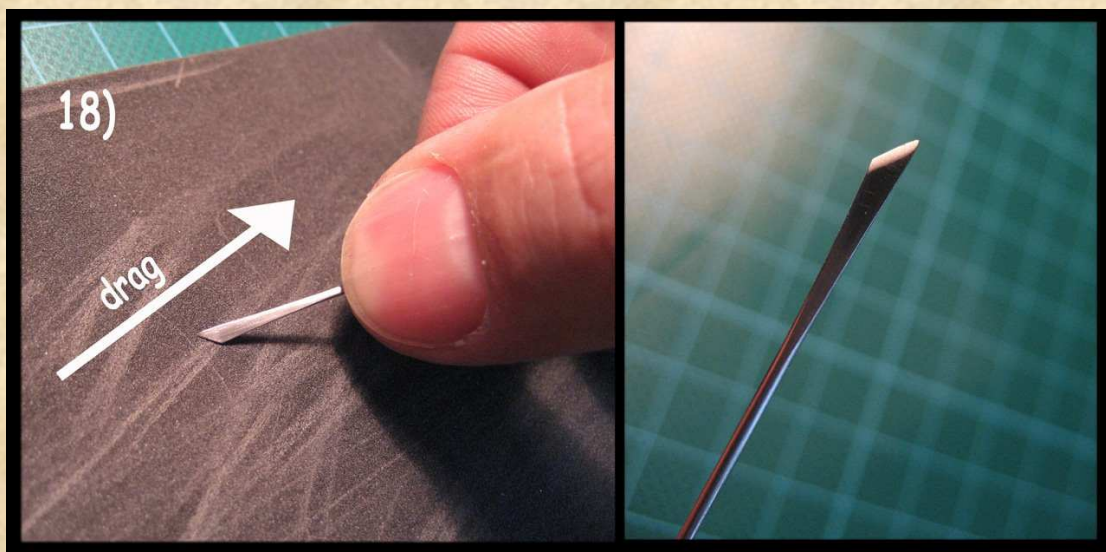

Again you just have to polish the mini knife tool tip and your new tool is done.

This tool is much better than using a hobby knife (like x-acto) in some cases because you can work more precisely in very small areas without blocking the view on the details with a large knife blade.

### THE ANGELED SPATULA TOOL

The next tool is also a kind of spatula, but because it's a little different to build, I give it a separate description. This kind of tool you can find quite often among the dentist tools, but not in this small size as we'll do it.

To build it, just prepare your spring steel and give it a rounded tip, like I explained for the rounded spatula tool tip. Then you have to bend the end of the tool two times, like you can see on pic. 19).

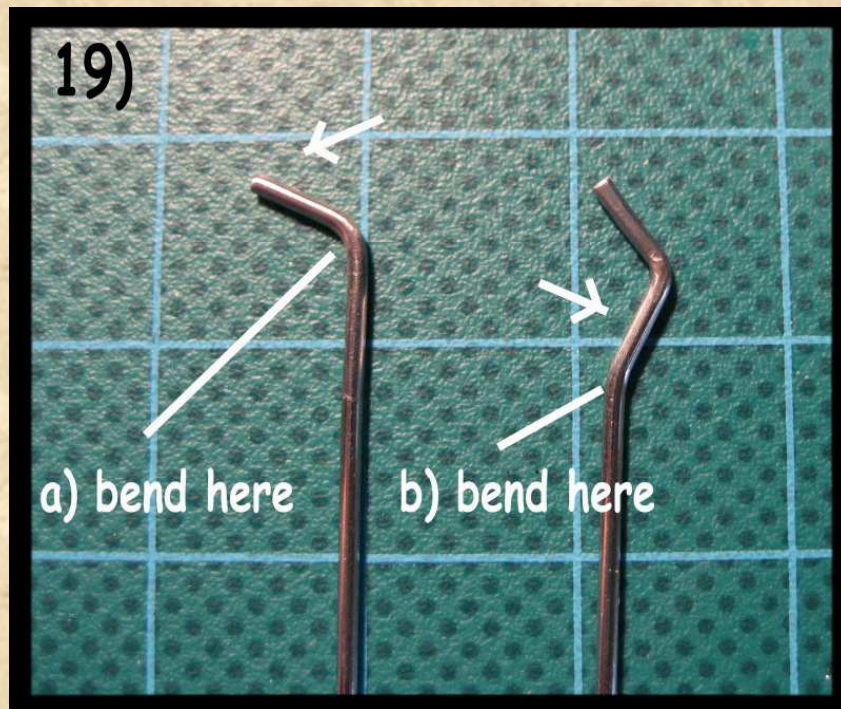

This time you can use pliers to bend the steel. Because it's not flattened and wasn't heated by now it should stand the bending. Because spring steel wire is quite strong, it took some strength to do the bending, but take your time and be careful not to hurt yourself. I found out, that the steel from the safety pin could be bent much easier this way than the conventional spring steel.

If you bent the steel rod the right way, you have to flatten the bended parts like you see on pic. 20). Again make sure to work equally on both sides of the tool tip to keep it symmetrical.

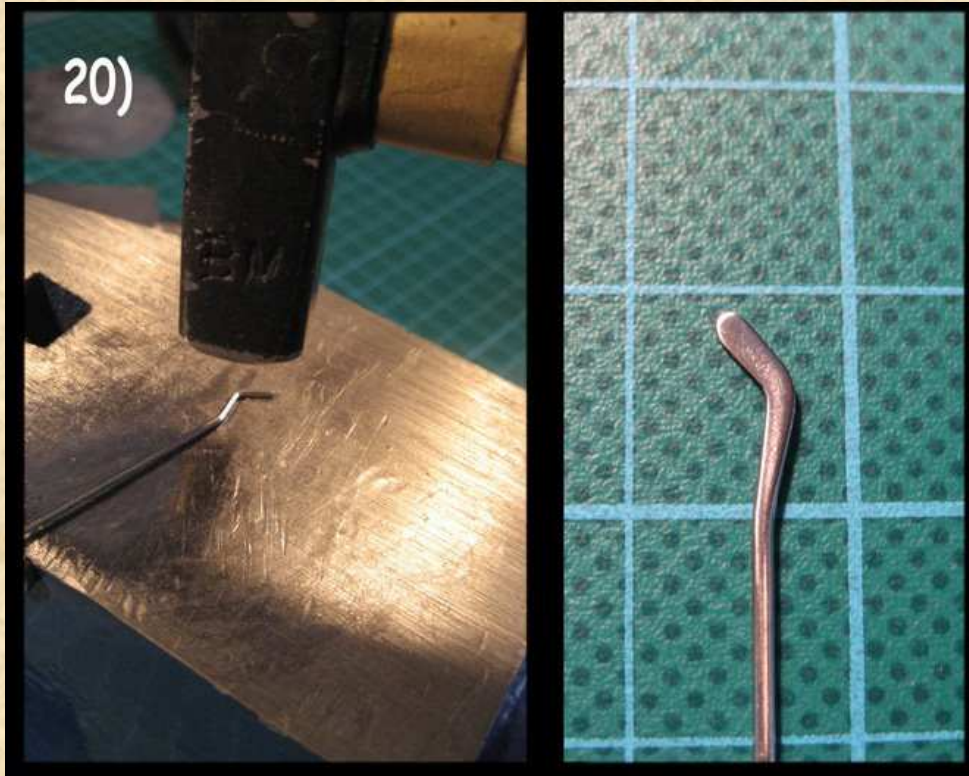

Again remove all scratches from the tool tips surface with the abrasive paper and you're done.

### **THE SCULPTING KNIFE TOOL TIP**

The next tool tip is one of my favourites in its 2mm version. I call it the sculpting knife because even it is not "sharp" it looks and you use it a little bit like a knife.

To start making this tool tip, you have to prepare your spring steel rod in a new way. This time you have to give the end of the rod the shape as it would be cut diagonally but with a light curve. I guess, that sound cryptic so I hope, pic. 21) can make it a little bit clearer.

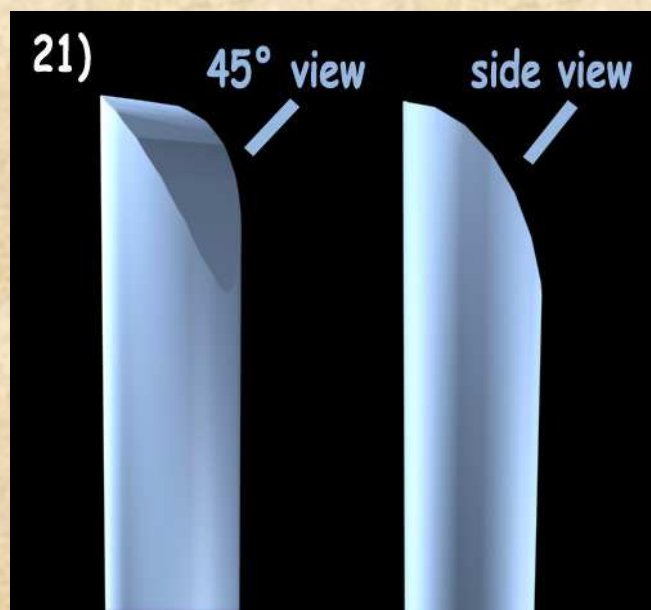

If you got your steel wire prepared that way, you have to flatten it with hammer and anvil until it looks like in pic. 22. Take your time and work carefully, because this form is a little more difficult to achieve.

And again: work equally on both sides. It's the same as I said about the spatula tool tips: Don't make it too flat, because you need some material left for grinding it later.

If you got the right shape, you have to grind the tool tip like you did with the spatula tool tips. I recommend giving this sculpting knife tool tip not a completely flat surface, but a slightly rounded one.

The "edge" of the sculpting knife should be sharpened, but not as sharp as a real knife or the mini knife tool tip, I've explained before. You don't have to cut things with it, just to push and smear putty from here to there.

A "too sharp" edge might be a disadvantage here because it could leave marks on the putty that you do not want. After all it should look like in pic. 23).

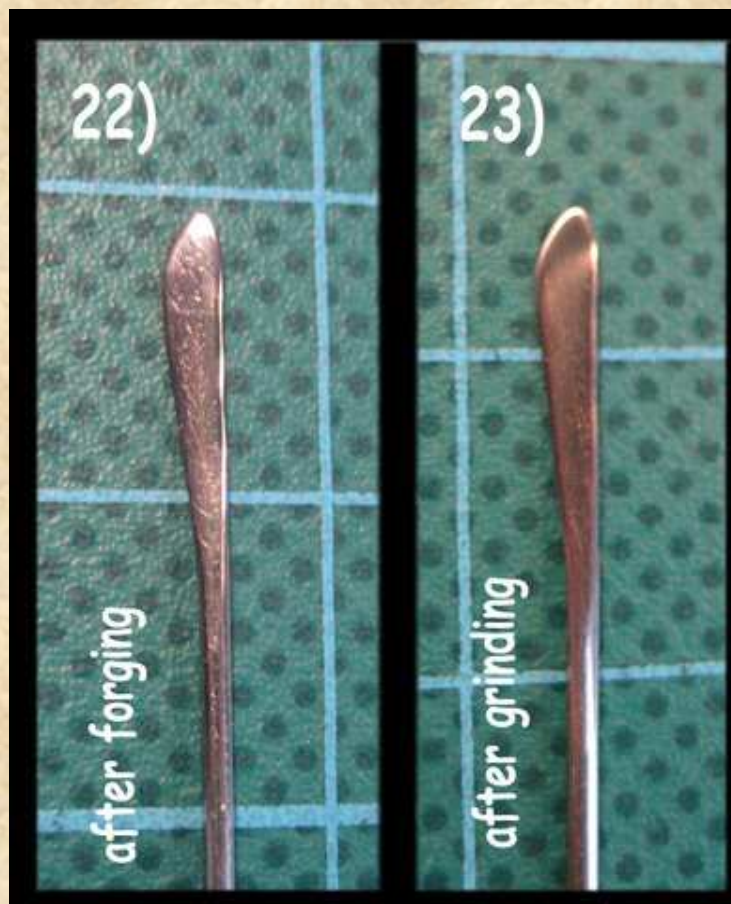

## THE FINGER TOOL TIP

This tooltip I call the finger tool tip because you use it like a small finger on your sculpting.

To start making this tool you have to prepare the end of your spring steel rod again.

This time you have to give it a tip, but not a sharp, pointed one, but more a little rounded one like you see on pic. 24.

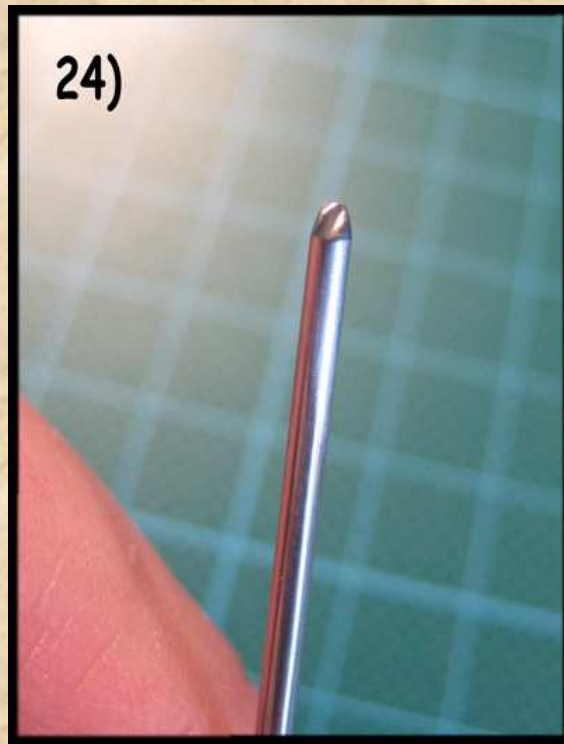

When you got this, start flatten the end of the steel wire with hammer and anvil after heating it up, like I explained above.

But just flatten it a bit and not too much. Don't flatten it as much as the spatula tool tips.

The flattened sides will be rounded later and you need to have some material left for grinding to give it the rounded shape.

After that you have to give the tool tip a shape like an "S" by first bending it in the one and after that into the other direction.

Pic. 25a) and 25b) will explain better what to do.

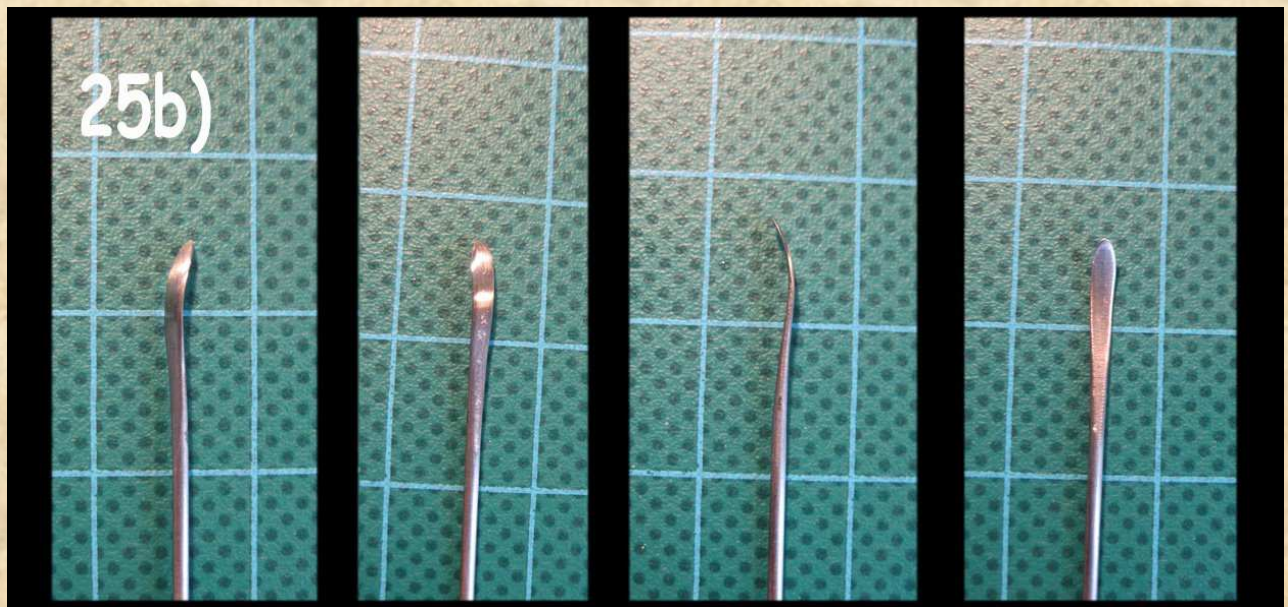

If you got the right shape it's time again for some grinding. You have to round the edges of the tool and also the flattened surface should have a slightly rounded shape. This time it is a little bit more work and it's a bit more difficult, because of the form of the tool tip and because the edges should be much rounder as on the spatula tool tips for example. Once again an abrasive pad would make this job easier.

Again after completing the shape, clean all scratches from the tool with fine abrasive paper and polish it.

I found this tool really useful and it's the other one of my favourite two tool tips (beside the sculpting knife). So it would be a good idea to have this both tool tips on each side of a two-sided tool holder. In a later tutorial I will show you, how to build such a two-sided-holder/handle.

## THE CURVED BURNISHING TOOL TIP

The next tool tip is a quite simple one. You just have to start with a rounded end of the steel wire rod like I explained for the round edge spatula tool tip. This time, you have to do the round shape very carefully so it is really symmetrical and looks like the half of a ball. Then you just have to bend the top of the tip a little bit like you can see on pic. 26. You can do this with heat, hammer and the cone-like end of the mini anvil or with pliers. If you use the hammer be aware not to flatten the steel, but just bend it. While using the pliers, be aware not to leave too many scratches on the tool tips surface.

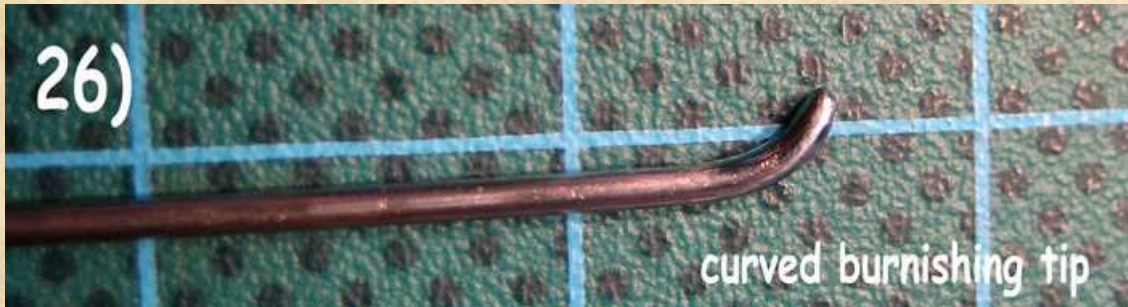

That's all. Just clean and polish the surface and you got a fine tool that makes a good job when it comes to smoothing out the putty, because it's a burnishing tool.

## THE RIVET TOOL

The last tool tip for in the 1mm size I call the rivet tool because you can make rivet-like structures with it while using it like a stamp. Even it is not really a sculpting tool, but more a sculpting aid and even you don't have to do any bending or forging here, it fits perfectly into the 1mm tool tip-range and that's why I explain it here.

The base of this tool is not steel wire, but a cannula. There are cannulas (hollowed needles) out there in different sizes and you have to get one with a 0,9 mm (or 1mm if you can find one) diameter.

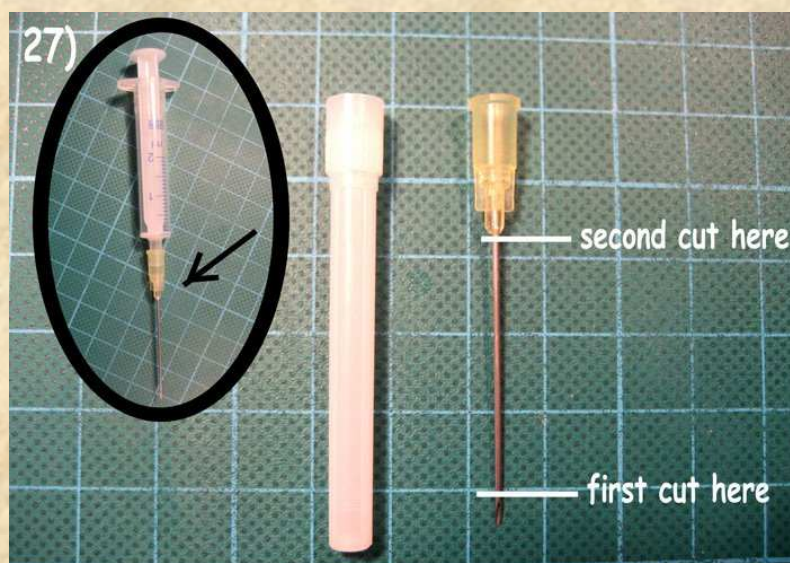



First cut off the sharp end with the cutting wheel and the rotary tool. Be careful, the edge is very sharp and wear safety glasses for that. Then cut the other end so you got a tiny tube with a length of about 4 cm. It is important to use the cutting wheel or even a very fine saw if you got one. But don't use nipping pliers or pincers for that, because they would press the sides of the tube together and make it worthless. All you have to do now it to refine the cut and to clean the edges of the tube. For that use very fine abrasive paper and maybe a needle that you slightly push into the tube and rotate it to remove all sharp metal pieces. I've found a very small cone-like grinding stone for the rotary tool for that (it's from a dentist), but I guess, not everyone out there has such a thing.

On pic. 28) you can see the final rivet tool tube.

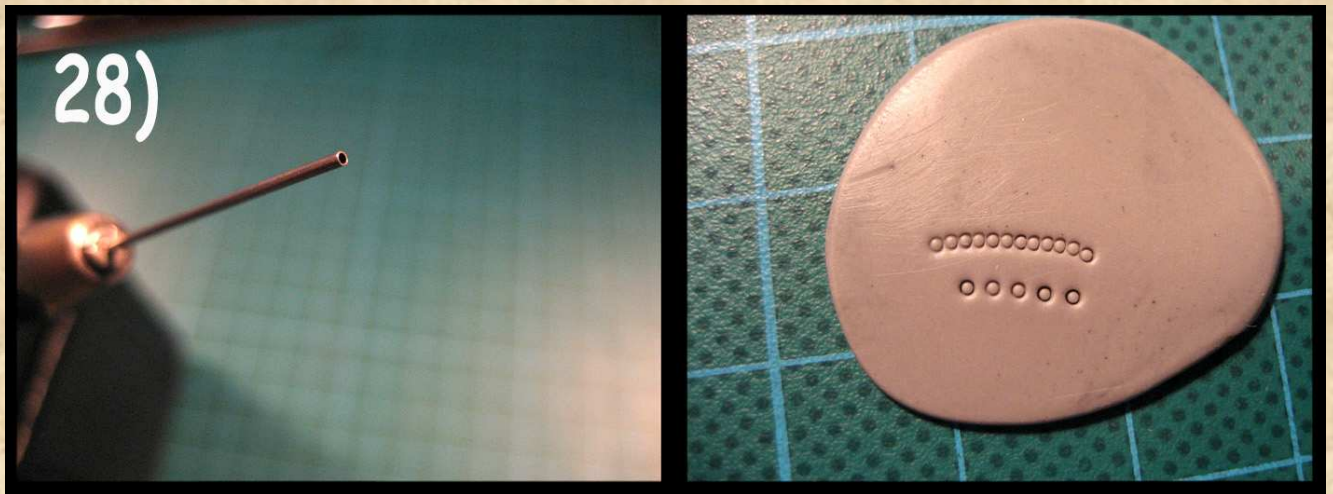

As I said, with this tool, you can create a rivet like structure while pressing the end of the tube into the putty like you see on pic. 28. So basically it's the simplest form of a "stamp-tool". In a later tutorial I will tell you a little bit more about the use of stamp tools for sculpting miniatures.

=====

## Tool tips from 1.5, 2 and 3mm steel

### General aspects:

In the last tutorial, I told you about how to use 1mm spring steel wire to make quite small sculpting tool tips. But you don't have to stick to this very small tool tips. As I told you before, I also recommend tool tips made of 1.5-1,6mm, 2mm and 3mm steel.

Basically you can build all the shapes of the 1mm-tool tips I've explained before also with those steel wires with larger diameters. All these tool tip shapes are also useful if made a little larger with maybe the exception of the curved needle tool tip and the mini-knife. In my eyes these shapes make only sense in very small versions, but you have to decide for yourself. Also those spatula tools in larger sizes can be found around, as they are used by dentists, so maybe there is no need to build them on your own if you can buy them cheap somewhere else. But if you want to make all your tools on your own and if it's not too much work for you, just do also the spatulas from steel wire with a larger diameter.

Personally I think the 3mm steel wire is a little too big for making most sculpting tools for 30mm sculpts. So I only made a few tool tips from 3mm steel wire. The sculpting knife tool tips made sense if made from 3mm steel, because sometimes you need a larger flat surface for getting the putty into shape (especially in the beginning while "blocking out" the basic shapes on the armature).

What I definitely recommend is to have the finger tool tip and the sculpting knife in every size (I mean made from 1mm, 1,5mm, 2mm and maybe even 3mm). Especially the versions with 1,5mm and 2mm I found very useful.

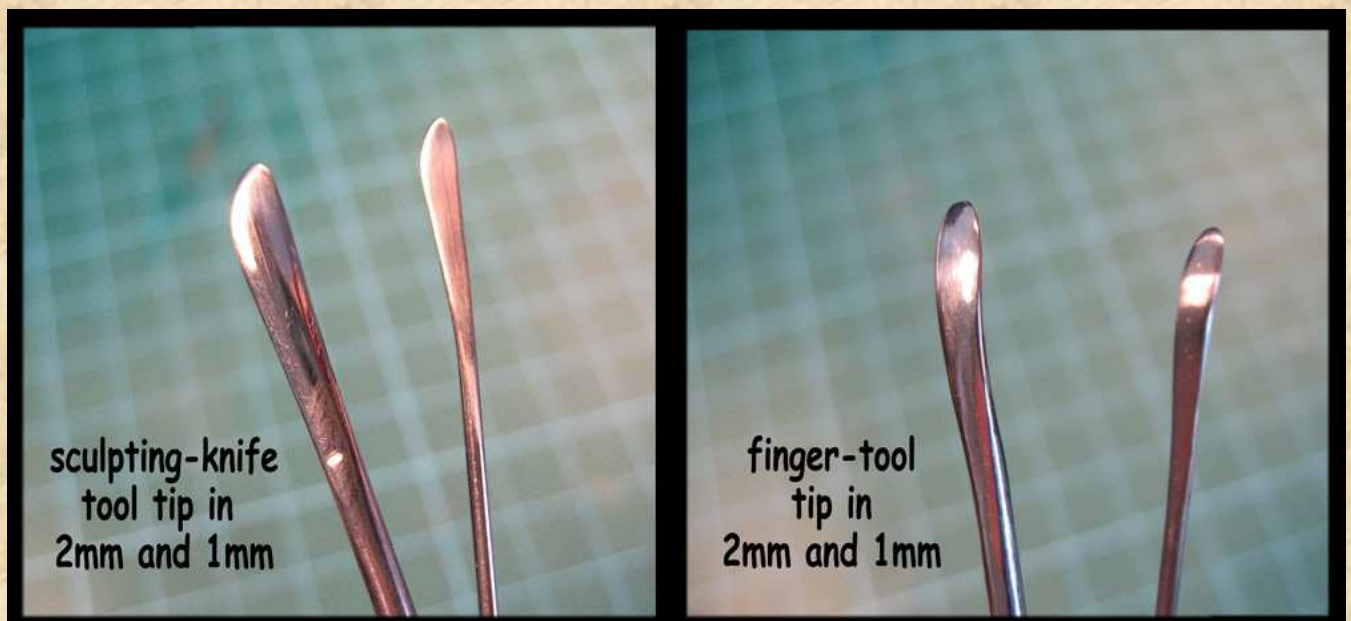

While you can build all the 1mm tool tip types also with larger diameter steel, there are a few tool tip shapes, that make only sense if they are built with larger diameter steel. Some of those I will discuss now. I'm sure, you will discover more tool tips for yourself if you work a little with hammer and anvil but don't make too many different tools or you might get lost between them all. Remember that not the tool makes a good sculpting, but the sculptors hand and mind. Even the best tool isn't a guarantee for a good sculpt. But on the other side it's also true, that bad or the wrong tools make it even harder to get a

nice sculpt. So that's why I want to point out some ways to make useful tools that at least doesn't make sculpting harder as it is anyway.  
So enough of small talk now, let's go on to a few more tool tips.

### **THE LONG PROBE TOOL TIP**

Another tool tip, I call the long probe, makes a lot of sense when it's made from 2mm steel. It's a long curved rod that gets thinner the more it comes to the tip and ends in a little rounded tip (not sharp or pointed). In some ways it's a bit like the curved needle tool.

To built this tool. You have to place the 2mm steel rod into the rotary tool. Be sure, that the rod sits tightly into the tool. Then it would be best, if you've got a GRINDING MACHINE like you can see on pic. 1). This can be bought quite cheap sometimes. But if you haven't got one, you can also use a belt sander or an electrical drilling machine (power drill) with a grinding stone. If you use the drilling machine, be sure, it is fixed securely.



Be sure to wear safety glasses when doing the next step!

Set the rotary tool with the steel rod into rotation and press it slightly onto the grinding stone from the grinding machine or the drilling machine. Be sure, that the grinding stone rotates in the direction the rod points. That's important, because otherwise it could be dangerous, as the grinding stone might "hit" the rod away. So slowly grind down the rod over a length of about 2-2,5cm so it gets a long point. Be sure, NOT to give it a sharp pointed tip like a needle. The tip that's left should be still rounded (pic. 2).

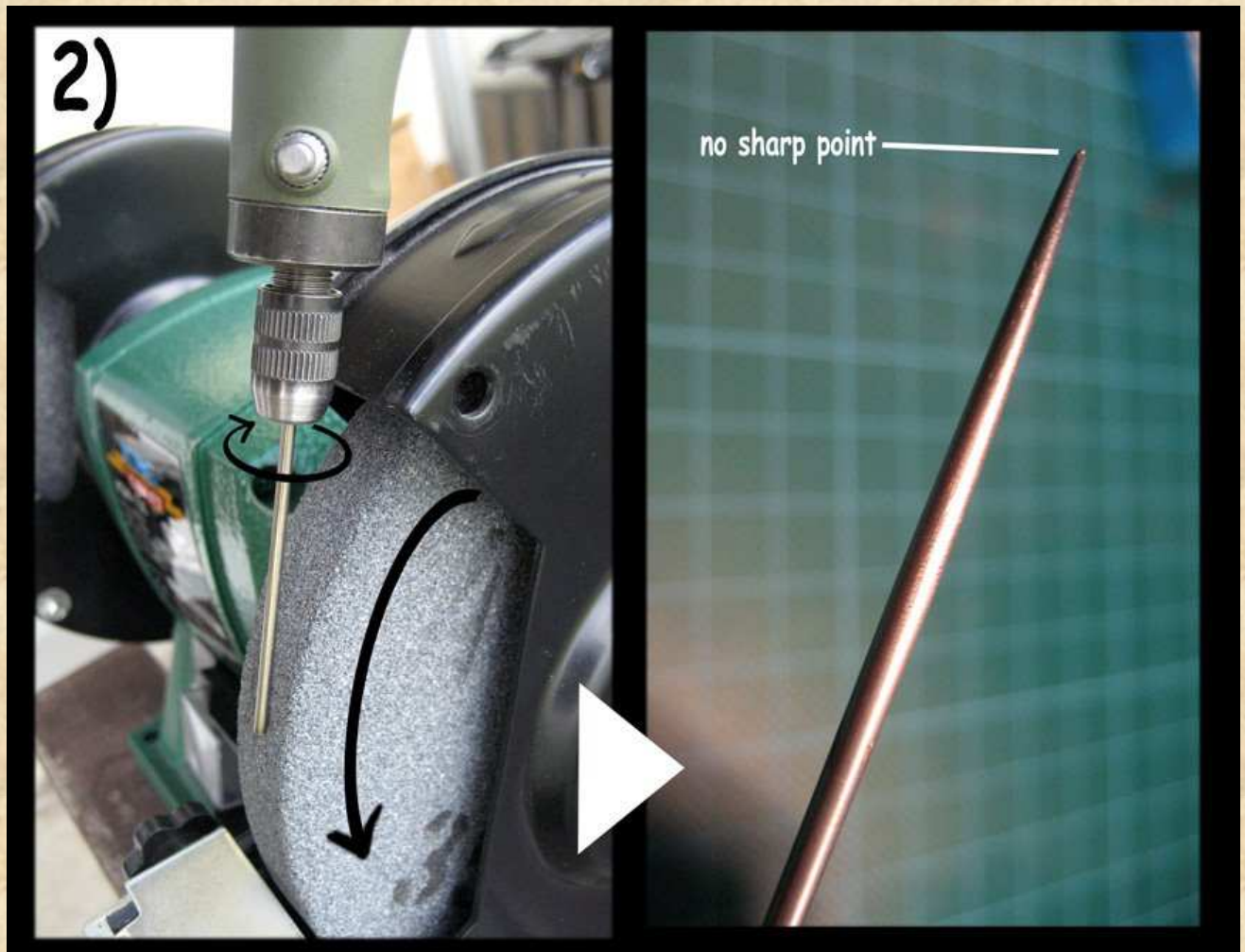

After grinding down the wire rod to the right shape, as always, you have to smooth the surface and remove all scratches.

You can do this quite easily if you leave the rod into the rotary tool and drag it slowly over abrasive paper. It would be better if you place the grinding paper on a soft surface (like rubber for example), so the paper can be pressed down a little bit.

Even better would be the use of an abrasive pad, if you got one. It might take a little while to smooth the surface, but don't hurry.

I recommend grinding the rod before bending it, because a smooth surface can be achieved easily and fast by using the rotary tool and the abrasive paper as long as the steel rod is straight.

After you've bent the rod, you can't use the rotary tool anymore that way and it would be much more work to do all the grinding by hand.

After cleaning up the surface, you have to bend the tool tip to the desired shape.

For me a kind of "S"-shape works best, but some people just prefer a simple curve (pic. 3). Here you have to try for yourself, what fits best for you.

You can do the curve with hammer and the cone-like end of the mini anvil or by carefully bending it with pliers.

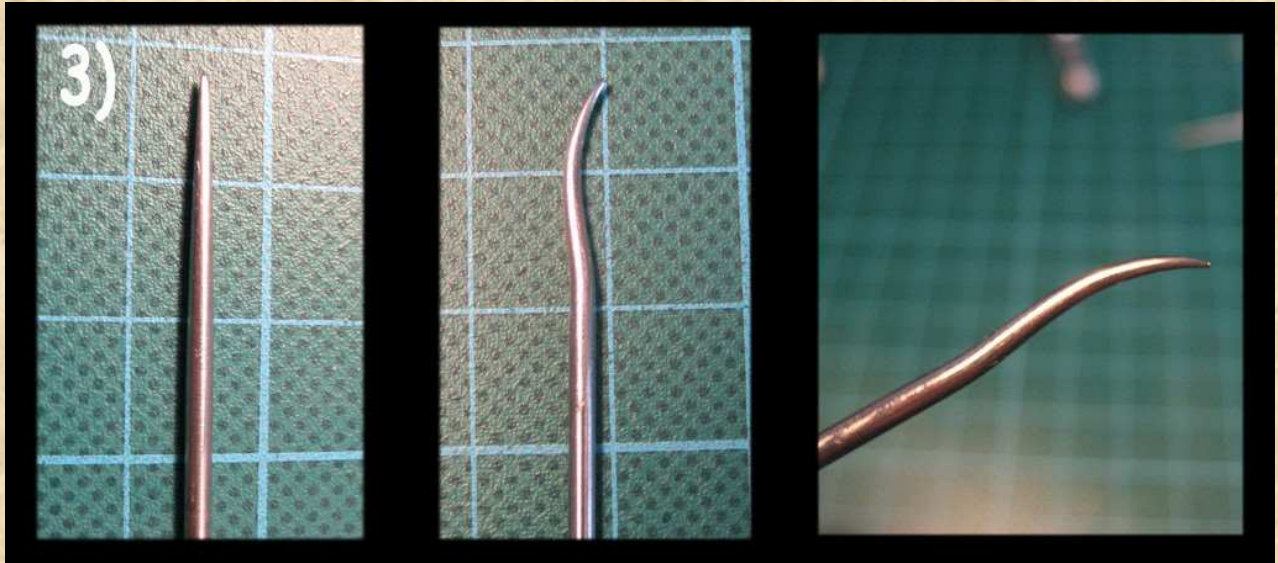

At last again do some polishing and there it is your new tool tip

### **THE POINTED SCULPTING KNIFE TOOL TIP**

The pointed sculpting knife is quite the same as the sculpting knife I've explained for the 1mm steel, but instead of the more rounded point of the sculpting knife, the pointed sculpting knife has a sharp point.

To make such a tool tip, you first have to do the normal sculpting knife as described before.

Then you have to cut or grind away a small half-circle like shape from the back of the sculpting knife, so it will get a shape that is similar to that of a Bowie-knife-blade (see pic. 4 on the next page).

You can do this by using the cutting disc in your rotary tool or a tiny grinding stone that is also available for those rotary tools.

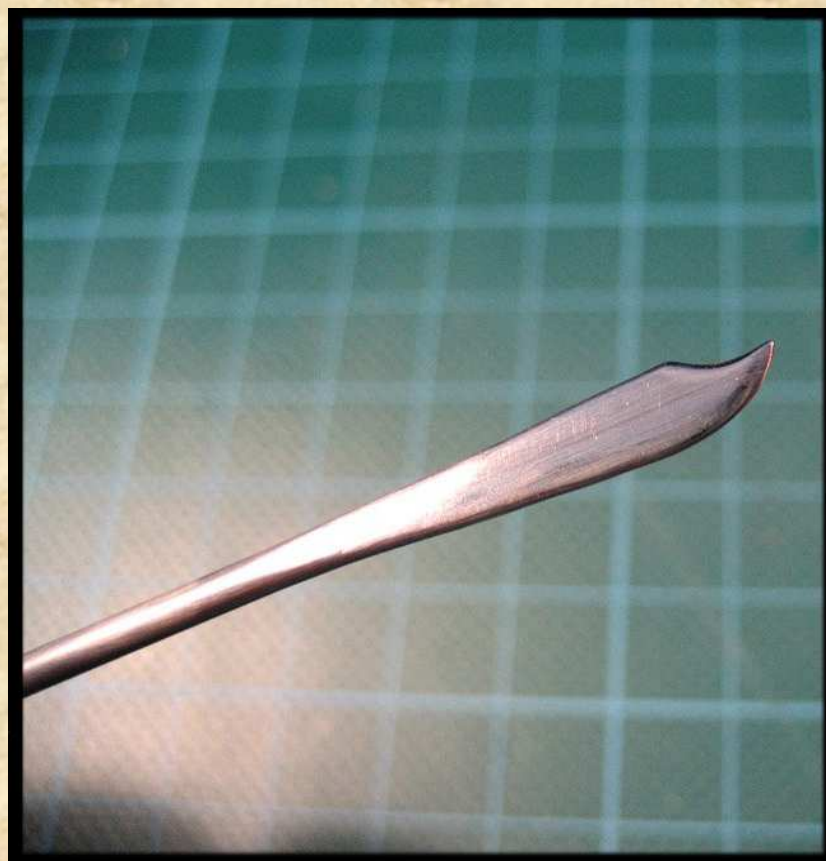
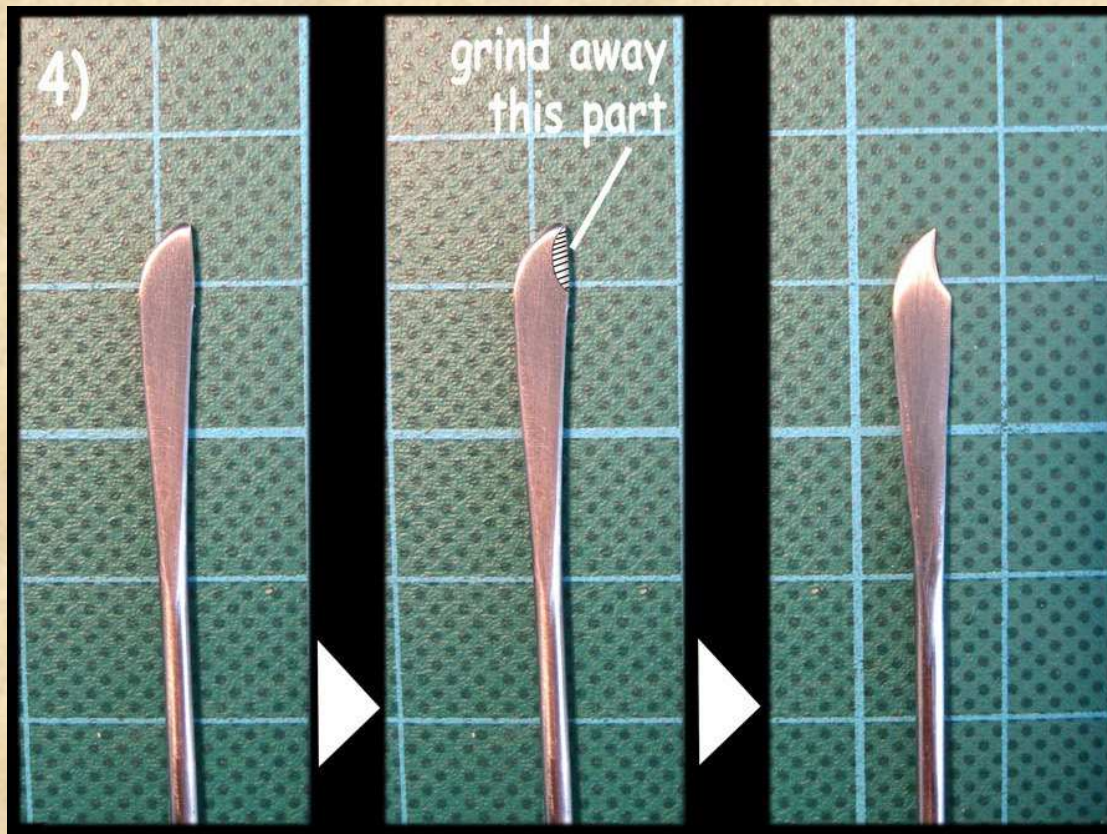

After getting the right shape, you also have to sharpen the new edge that you've created with the grinding stone.

Because this edge is concave, it's a bit tricky to sharpen is.

One way to do it is to wrap fine abrasive paper around an object with the same diameter as the half-circle you've cut out (like a screwdriver or a larger nail or something like that).

This you can use now as a kind of fine file to sharpen the concave blade (see pic. 5).

As I said before, "sharp" doesn't mean here it has to be like a razor blade.

You don't have to cut something with this tool tip.

"Sharp" means here, that the tool gets thinner, as it gets to the edges.



Again do some polishing and you've got a new tool tip.

By the way: If you combine this pointed sculpting knife tip and the finger tip, both made from 2mm steel wire on one handle as a double sided sculpting tool, you got something, that is quite the same as the famous "Wax 5".

=====

## THE ANGLED CONE TOOL TIP

This is a tool you might also find among the tools for dentists or dental technicians even in small sizes.

So you don't have to forge this tooltip necessarily on your own, if you can find it somewhere else. But if you want, this is how you can do it:

You can do this tool tip from 1,5, 2,0 or 3,0mm steel wire, but I think, the 3,0 wire would make a tool tip, that's a little bit too big.

For me, the 2mm v2a steel wire works best for that tip.

So first give your steel rod a long pointed tip. Make the tip, like I've explained for the long probe tool tip. But this time make the pointed tip shorter (about 5mm).

You can make the pointed tip like a cone (pic. 6a) or more like a bossed cone (like a cone that has been "blown up" with rounder edges, pic. 6b).

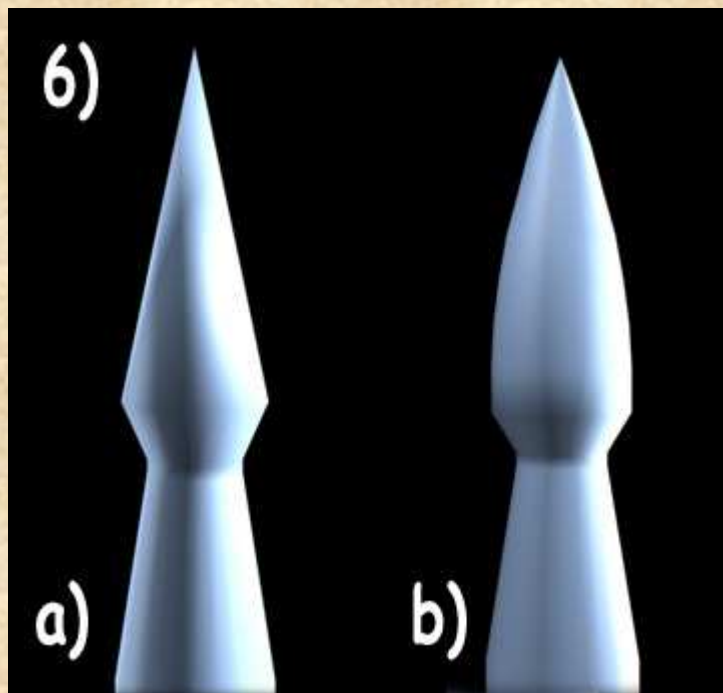

Then cut in a circular furrow under the tip. Don't make this furrow too deep but just enough to form the cone-like tip. You'll have to bend the steel later.

If you make the furrow too deep, it will break. To get this furrow with an even depth is a bit tricky.

For me the best way was to use two rotary tools (or one rotary tool and a power drill).

The first rotary tool with a cutting wheel was fixed into a bench vice, while the other rotary tool holds the steel rod with the pointed tip.



Then, while rotation both, the cutting wheel and the steel rod, touch slightly the edge of the cutting wheel with the rotating steel rod at the right point.

Don't press too much and try to avoid the steel rod starting to vibrate (pic. 7).

The space between the tip and the furrow should be about 4-10mm, depending on the steel rods diameter.

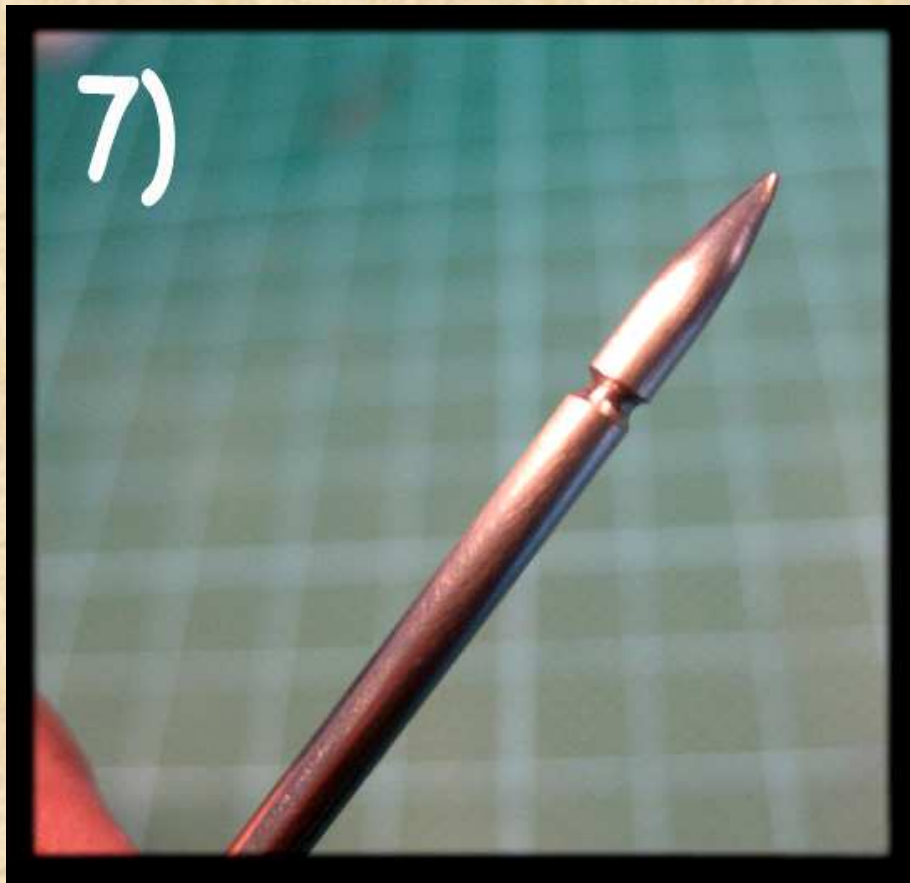

In the next step you have to bevel the edge of the furrow that faces away from the tool tip.

You can do this also by slightly touching the rotating cutting wheel with the rotating steel rod, but be sure, not to accidentally damage the already shaped tool tip (pic. 8).

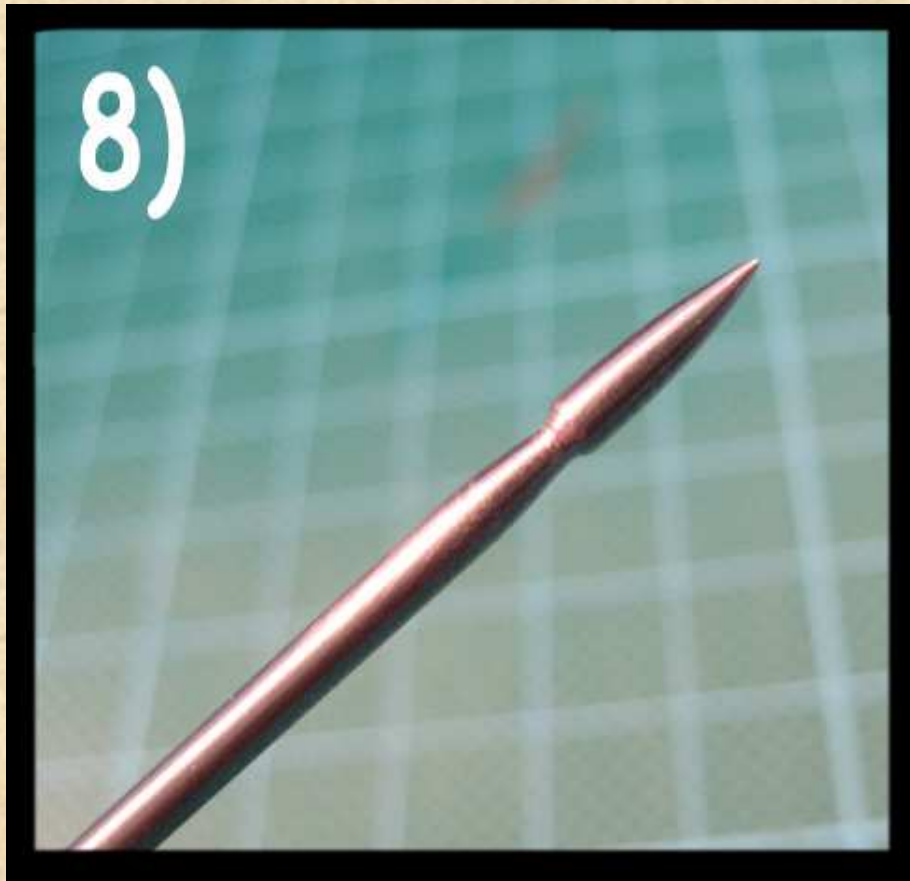

After that clean up the surface of the tool tip and remove all scratches with abrasive paper and abrasive pads (keep the steel rod rotating in the rotary tool and drag it slowly over the abrasive paper).

At last you have to bend the tooltip, because then it's easier to reach difficult areas on your sculpt. Do it like you can see on pic. 9.

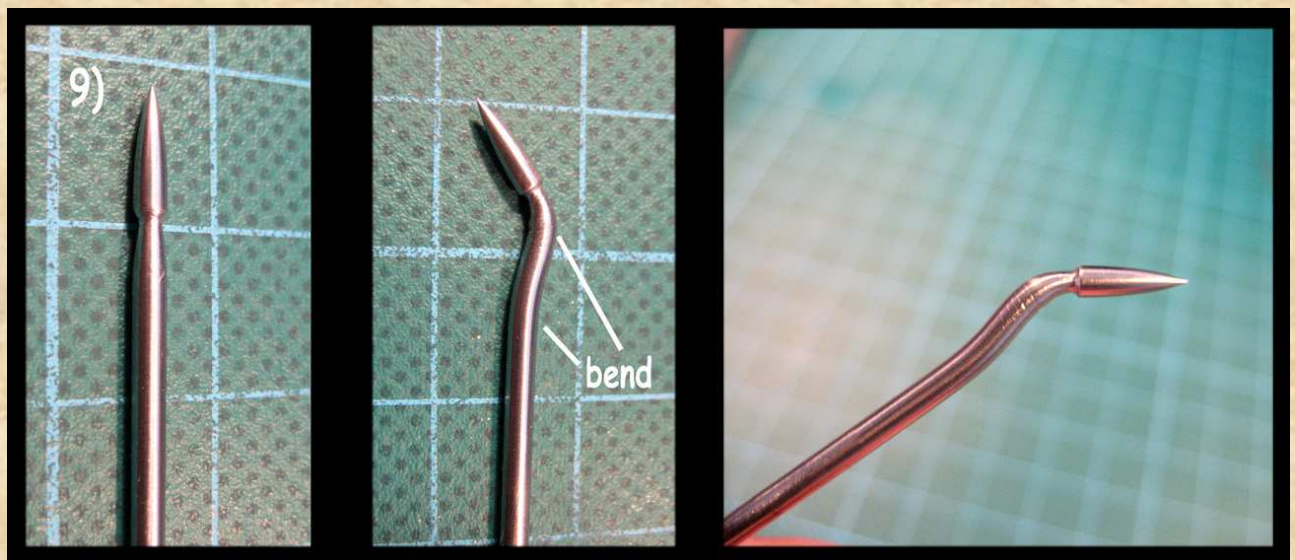

Finally polish this tooltip and you're done.

This tool is quite good especially while working on drapery and wrinkles.

## THE DIAGONALLY CUT TOOL TIP (or "the eye tool")

This kind of tool tip I first saw on sculpting tools made by the German sculptor Stefan Niehues.

You can do this tool tip with every steel rod diameter you like and it always makes a nice addition to your tool set (even the 3mm version), because every size can be used for different sculpting needs.

With the smallest version, you can also form eyes, because with its special shape you can work out eyeball and eyelid quite well (if you got a calm hand of course). That's why this tool tip is also called "eye tool".

Basically the tool is just a steel rod that is diagonally cut, so it gets an angular (bevelled) tip.

And that's how you can do it:

For a larger diameter tool tip, just make a diagonal cut into the steel rod with the cutting wheel and the rotary tool.

If that doesn't work well, you can also make a straight cut and grind it down with the cutting wheel, so it gets an angular shape (pic. 10).

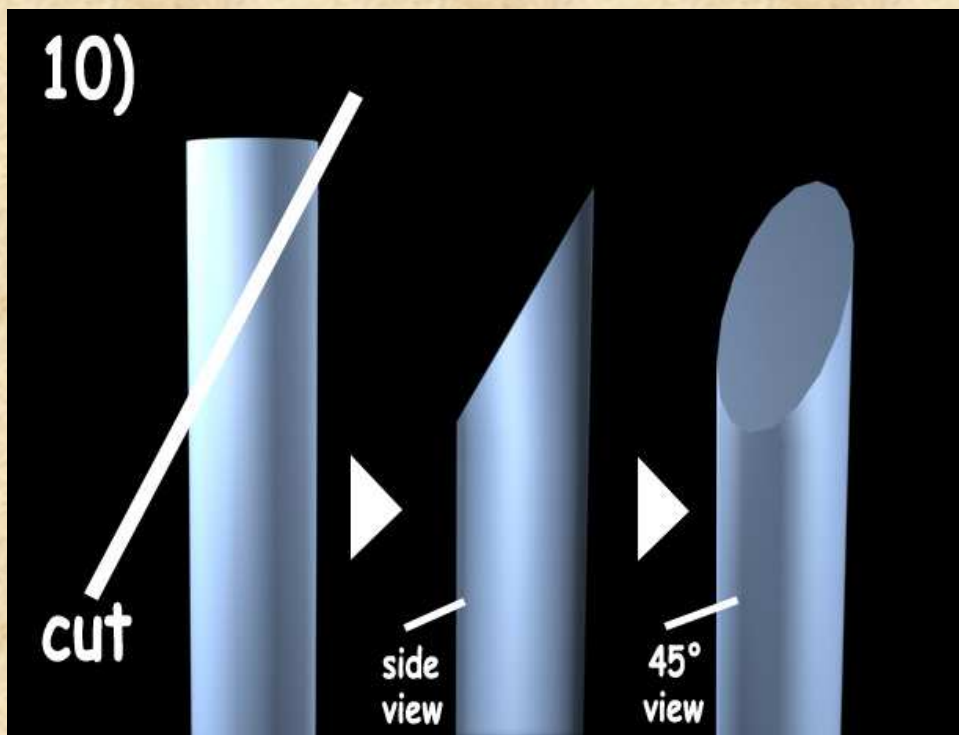

For the smaller diameter tool tip, it might be a good idea, to take a larger diameter steel and to grind it down so it gets a long tip before shaping the angular tip from the narrowed rod (pic.11).

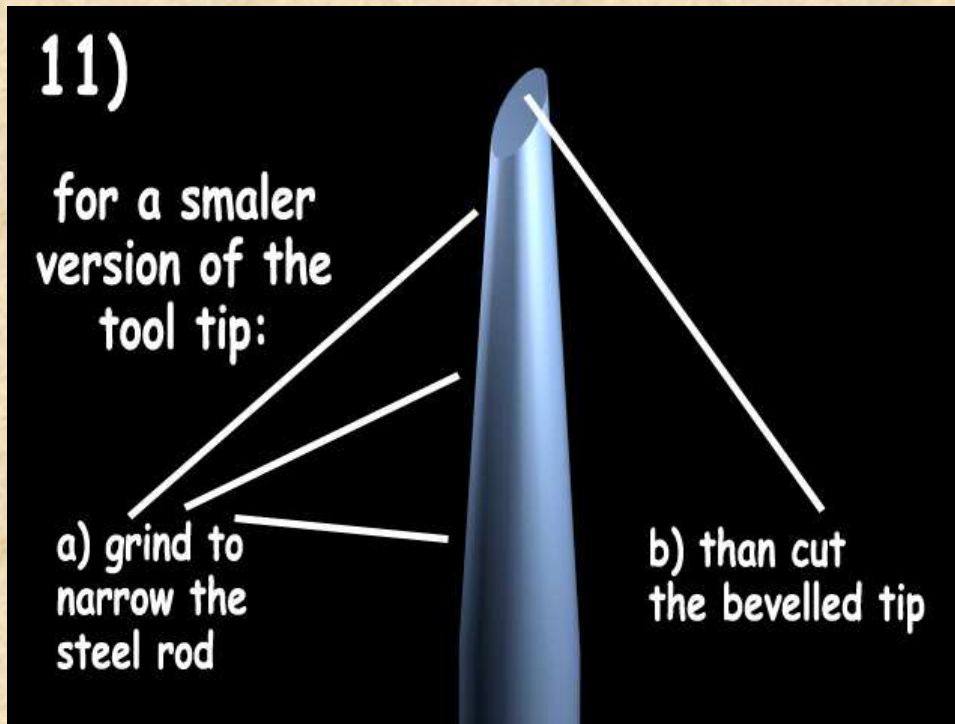

Then you have to clean the surface from the scratches as always. But be sure to leave the edges at the narrowed tip "sharp".

So don't use the abrasive pads here, because they will round the edges. Just take fine abrasive paper, place it on a hard surface with the grind-side facing up and drag the narrowed face of the tool tip over it, so it gets perfectly flat (pic. 12).

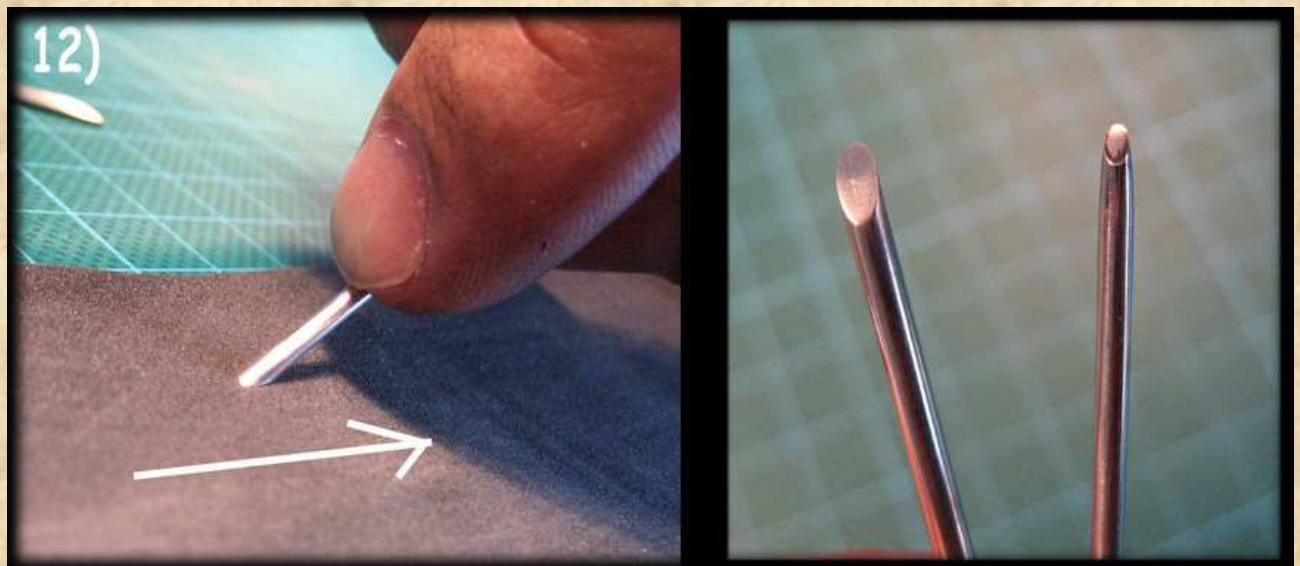

Finally as always polish your tool tip but be sure not to round up the edges while polishing.

Stefan Niehues told me, that this tool tip is even better, if its narrowed face isn't just 100% flat, but a little bit concave (dished). To achieve this, you would have to work with a ball-shaped grinding stone on a rotary tool and a very calm and firm hand. But if you like, just try this.

## THE LONG SCULPTING KNIFE TOOL TIP

There's one last tool tip that I want to explain for now. I call it the long sculpting knife and some sculptors told me, that they prefer to work with a tool tip like that.

Basically it looks like a knife blade. Maybe you've seen sculpting tools with similar tips among the tools for dental technicians. Even Games Worksop sells such a tool, but I didn't like that so much because it's quite rough and not shaped tidily (at least the one I bought some time ago).

To build a long sculpting knife tool tip, basically you have to start like I've explained for the straight spatula tool tip. But this time flatten the steel over a longer part of the steel rod.

Remember, not to make the tip too flat (thin) because you also have to grind some material off for a good surface. After flattening the steel, just give it a knife-like pointed tip like you can see on pic. 13). Then "sharpen" the curved edge of the sculpting knife.

Keep a smooth rounded surface while doing that, so that there are no edges on the flat sides of the "blade". Remember: "Sharp" doesn't mean razor-like here. Just give it a thin edge. You could leave the straight edge of the sculpting knife (the backside of the "blade") blunt or you can also sharpen it. After that remove the scratches from the surface and do some polishing and you've got another tool tip.

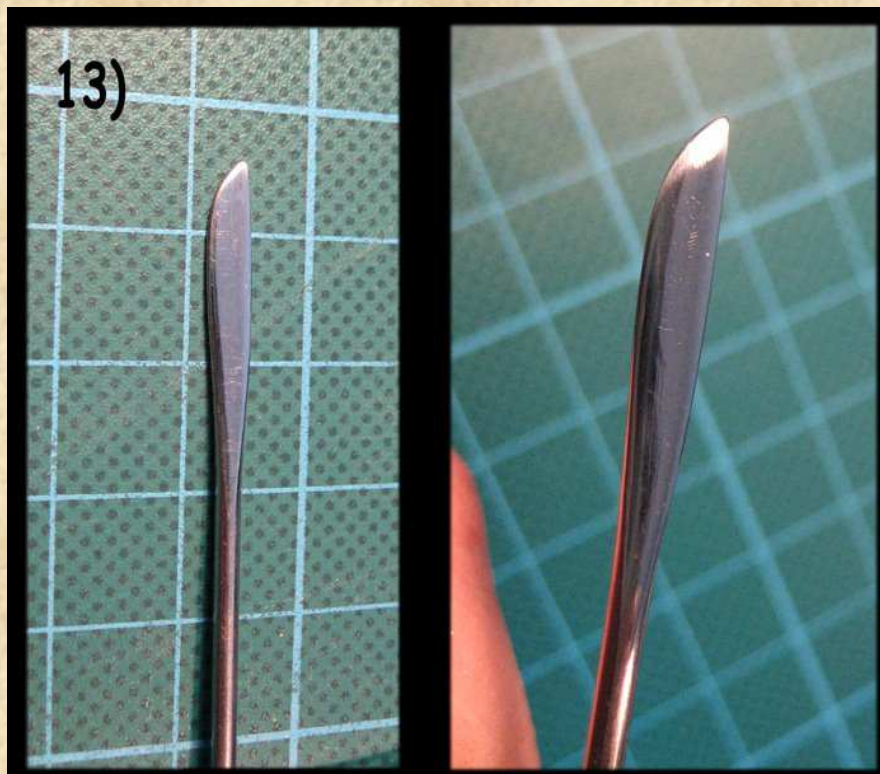

So I think, for now, there are enough tool tips for you to build, and I think it might be good to stop here for now. I guess, you will invent some more useful tool tips if you get familiar with the forging procedure.

In the next chapter I will tell you about how to polish the tool tips.

## POLISHING SCULPTING TOOL TIPS

As I promised before, today I will explain how to polish your sculpting tool tips. Because polishing isn't such a complicated thing, I won't make many words about it; just some hints.

Before polishing, make sure, that you've cleaned up the surface of the tool the best you can, by removing all scratches with fine abrasive paper.

Fine scratches can be polished away, but deeper ones have to be removed with the abrasive paper. Even better than abrasive paper are abrasive pads.

For the polishing you need some kind of polishing tool (pic 1).



If you really want to do a lot of tool tips, maybe you should get a cheap polishing machine. That's a machine similar to the grinding-machine that I've talked about before, but just with two felt-wheels instead of the grinding stones. If you already own such a grinding machine, it's most likely, that you can buy separate felt-wheels to replace the grinding stones on your machine. That would be cheaper than buying a second machine.

But if you just want to make a few tool tips for yourself, you won't need that. If you got a rotary tool, you can find small polishing wheels to fit into it that makes the job quite well and they aren't very expensive.

If you haven't got a rotary tool (Dremel or Proxxon or something like that), you can also find such a polishing wheel made of felt to fit in an ordinary electrical drilling machine (power drill), that can be found in most houses.

I prefer the polishing machine or the rotary tool over the drilling machine because of the higher rotation speed (and the lesser noise they produce).

Second you need some kind of Polishing Agent. For the small rotary tools, it is usually available in small plastic boxes. For polishing with the larger polishing machine, they are also available in form of a bar, like you can see on pic.1. If there are different types of those polishing agents in the shop and you are unsure which one to take, ask someone from the store which is the best for polishing steel.

All the tools and the polishing agent can be found at hardware stores or building centres.

If you got your polishing tool, let it rotate.

Then first press the polishing agent slightly onto the rotating wheel, so the felt can take up some of it.

Now take your tool tip and slightly press it onto the polishing wheel (pic. 2). Be sure, the tool tip point into the same direction as the rotation of the wheel. If you have problems to hold the small sculpting tool tip in your hand without letting it fly around, you can fix it in some kind of pin vice to get a better handle.

Soon you will see that the polishing agent gets fluid and turns into a dark grey colour because of the steel particles that were polished off. That's good because it means that it works.

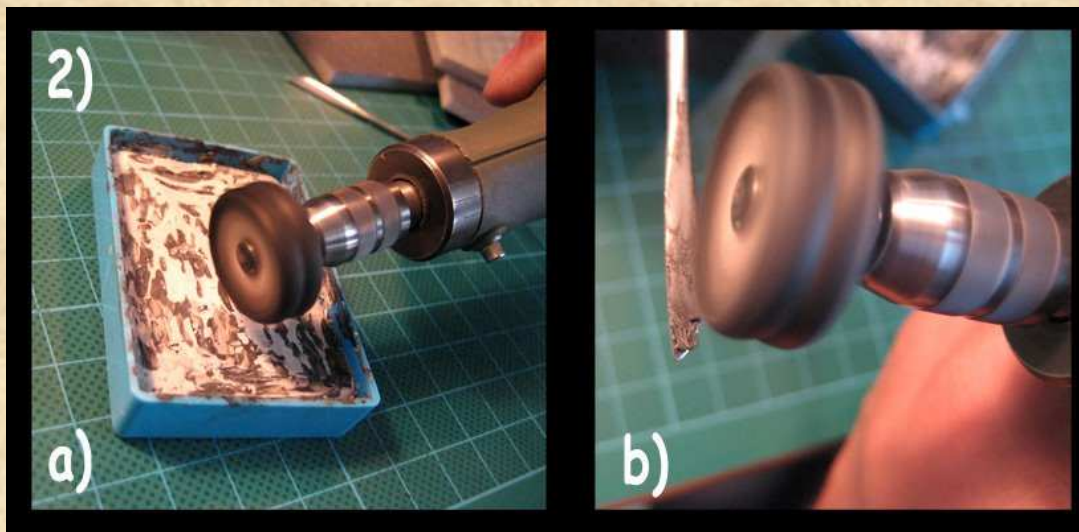

Once again, wear safety glasses and NOT your best shirt while polishing, because this black fluid drops (and sometimes even the tool tip) tends to fly around.

Check your progress from time to time, by whipping off the black fluid from the tool tip with a tissue or some fabric to see the surface under it. If the surface is perfectly shiny and no scratches can be seen anymore, your tool tip is done and you can start polishing the next one.

That's all about polishing from my side.





## THE SCHELLERT TOOL - the hard way

In this tutorial I want to show you how to build the "Schellert-Tool".

The Schellert-Tool is basically nothing more than a small tube with a metal-clamp-system on each side, where you can fit sculpting tool tips in. The tooltips could be stored inside the hollow tube (pic. 1).

This tool has some advantages over the pencil tool because it is a two-sided tool and the sculpting tips are fixed more tightly in it, so they won't rotate. You can make versions of this tool for all steel wire diameters (more about that later). I called this tool "Schellert Tool" because I didn't find another name. "The-two-sided-sculpting-tool-with-exchangeable-tool-tips" was a little bit long for my taste. So I gave it my last name, that's all.

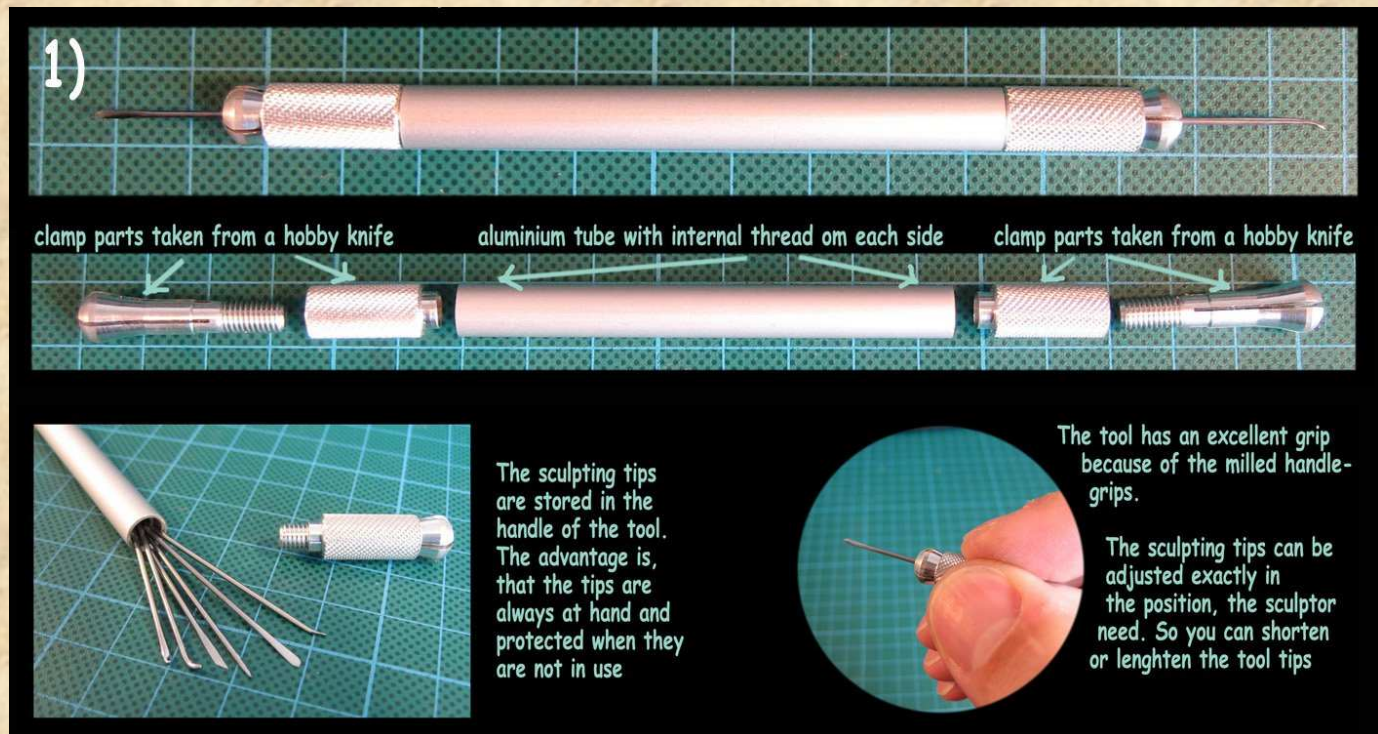

If you ask yourself why I wrote in the title of this post "the hard way", it's because you have to do a little metal working like cutting threads for example. There is also an "easy way" to get a kind of a Schellert Tool which is nearly as good as the original one with a minimum of work. I'll tell you in a later tutorial how to do this.

The basic idea behind the Schellert tool is to grab two of those hobby knives (like x-acto, excel, proedge, martor or ecobra to name a few), get the clamps from these knives where usually the blade is placed in and fix them on each side of a small aluminium tube by cutting threads into the tube.

Of course you can just use the hobby knife as it is and fix a tool tip instead of a blade in it, but that's only a one-sided tool, you can't store the tips inside the handle and hey, it's not so cool.

## Material and tools needed:

### Two hobby-knives (pic. 2):

First you need two hobby knives to get the clamps. Here's where the "trouble" begins.



These knives are produced in different countries and therefore the threads of the clamps of these knives are different.

The knives from Germany like those from Martor and Ecobra are using a metrical thread-system. In fact they have an "M5"-thread.

The knives from Excel and I guess even the knives from x-acto and proedge (I guess they are from the US) using another thread-system. They have a UNC 10-24 thread.

You have to know which thread your knives have because you need the right thread-cutter (threader) for cutting the thread.

I recommend using two knives from the same manufacturer.

Regarding these knives it is worth to look a little bit around for the prices, as there are great differences even for knives from the same manufacturer.

So for the ECOBRA-knife for example I found the range from 2.10 EURO to 9.90 EURO and it was always the same kind of knife.

So google until you find an acceptable price.

As far as I can see (here from Germany), the prices for those knives (especially EXCEL and PROEDGE) are a little bit lower in the US, so lucky you, if you live there.

### Thread cutter and holder:

As I said before, you need a thread cutter (threader) with the right size. Depending on the kind of knifes you use you'll need either a thread cutter for M5-threads (German) or one for UNC 10-24-threads (US).

You have to take those thread-cutters for cutting threads by hand, not those for machine-thread-cutting.

There are two types of hand-thread cutters around. The first exist of only one drill-like tool, and you can cut the complete thread in just one turn with it.

Then there is also a set available that exists of three drills- like tools. One for pre-cut (marked with one line), one for the second cut (marked with two lines / cuts a little deeper) and the last one for the final cut (marked with no lines / complete thread).

If you have the choice, take the 3-piece-set. It's a bit more work because you have to cut three times instead of only one time, but cutting is easier with the set because you'll need less power. And because the forces that work on the tube while being cut aren't as high, it's not so likely, that the tube will rotate in the bench vice while cutting the thread.

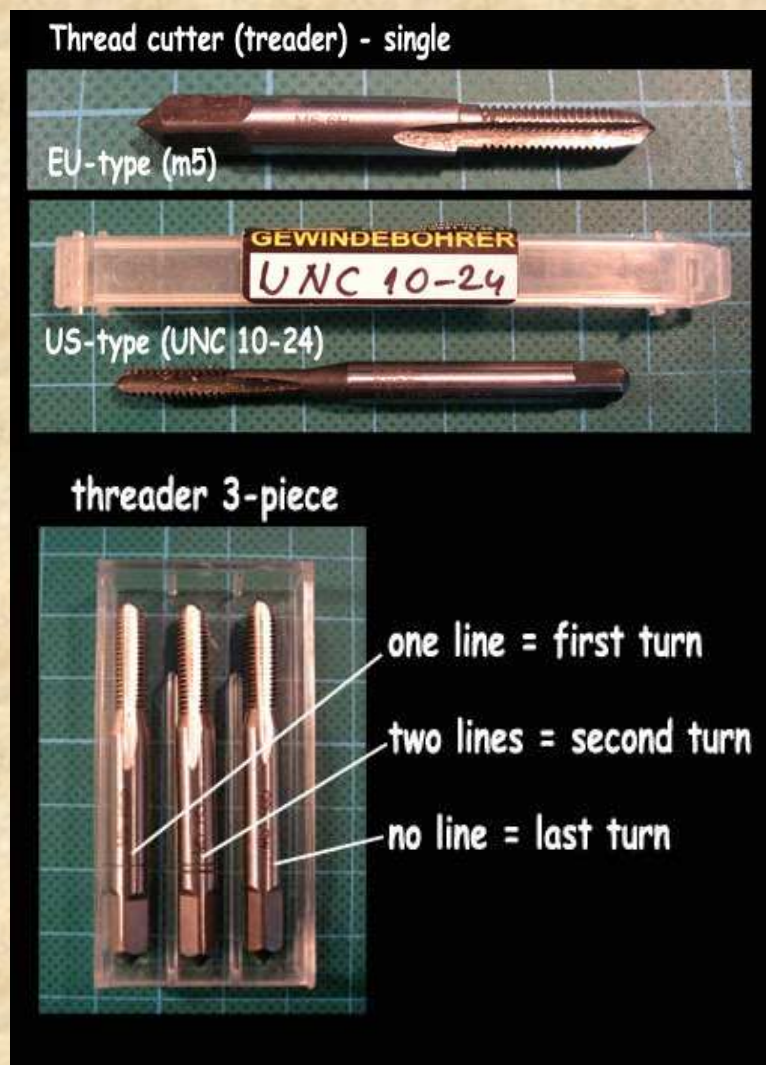

And of course you'll need a holder for your thread cutter like the ones you can see in the following pic.



#### **Aluminium tubes (pic. 4):**

You need two aluminium tubes like those you can find in hardware stores or building centres where you can buy them in 1m or 2m length. The 1m size is more than enough.

You'll need

- one with an outer diameter of 8mm and an inner diameter of 6mm and
- one with an outer diameter of 6mm and an inner diameter of 4 mm.

The strength of the tube walls is 1mm on both tubes (just to make it clear).

There are two kinds of aluminium tubes that can be found, those with a pure aluminium surface and those with an anodized surface. In hardware stores or building centres (in Germany) most of the times the anodized ones can be found.

You can use both versions. The anodized ones have the advantage, that the surface of the tubes has already a finish, so it's less work later. The "pure" aluminium ones have to be grinded and polished to remove scratches, but this will result in a very beautiful shiny surface.

But one thing is very important about these tubes:

The smaller 6mm one should fit easily into the larger 8mm one!

That's not always the case, because those tubes have never exactly the sizes, they claim to have.

So before you buy the tubes find a pair that will work.  
I mean you need a quite large 8mm tube and quite small 6mm one.

Try every 8mm tube with every 6mm tube until you find a 6mm one that fits into the 8mm one.

If you don't do that you'll get into trouble because you have to widen the 8mm tube later, so the 6mm will fit in. And believe me, this is something, you didn't really want to do if it can be avoided, because it's really a mess (you shouldn't make my mistakes).

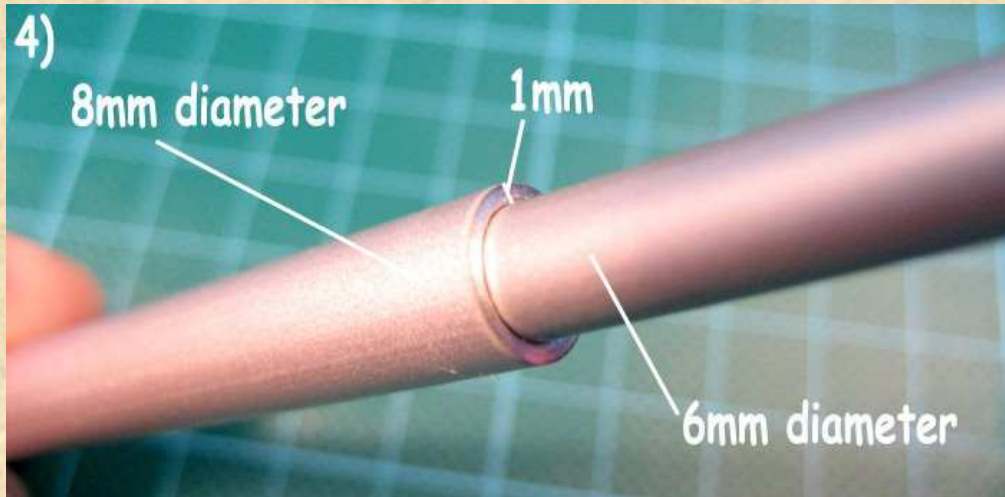

#### **Bench vice with protection bars (Braces) (pic. 5)**

You'll need a bench vice, where you can fix the aluminium tube in while cutting the threads.

To protect the surface of the aluminium tube, you need some kind of protection bars (braces).

The one you see on pic. 5 I made on my own from strong felt.

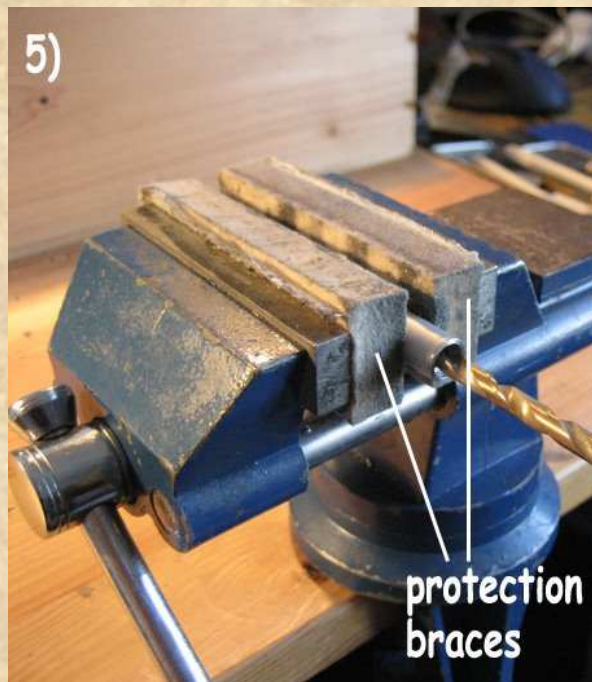

**Fine metal saw or tube-cutter (pic. 6):**

You have to cut off pieces from the aluminium tubes. To do so you will need a fine metal saw or even better a tube cutter or pipe cutter (see pic. 6).

The tube-cutter is a very fine tool and not even is cutting much easier with it; you'll always get a clean 90-degree cut from the tube.

So when using the tube cutter you'll have less work to do to clean up the cut.



**Electrical drilling machine (power drill) and 4,2mm metal drill:**

If you use the knife-clamps with the M5-thread, you will also need an electrical drilling machine and a drill with the size of 4,2mm. This must be a drill for metal (not for wood) of course. You'll need this drill to widen the inner diameter of the small aluminium tube from 4.0mm to 4.2mm because for cutting a M5-thread you need a base hole of 4.2 mm.

If you use the other knife clamps with the UNC 10-24 thread, you are lucky, because for this thread-size a base hole of 4,0mm is fine and that's the diameter, the small aluminium tube already have. So no need for a special metal drill or the electrical drilling machine in this case.

**Good glue for metal:**

You'll also need good glue for metal. It's not important, that it is fast, but it is important, that it is really hard and strong in the end. I recommend those two-part epoxy glues.

**Abrasive paper:**

You'll also need some fine coarse grinding paper to clean the cuts on the tubes.

**Oil:**

When you cut the threads into the aluminium tube, you need to dip the tube cutter in oil before. Otherwise cutting is much harder and the tool might get stuck into the tube, so ALWAYS use oil when cutting threads. When I did the first thread cuttings, I just used ordinary sunflower oil that is used in the kitchen. Later I bought an expensive special super metal drilling and cutting oil. But believe me or not, I found the sunflower oil works better, so I'm now back to that. Maybe some metal-working-professionals will get a heart attack now, but that's what I found out for me. So there's no need for you to buy special cutting oil. Just try what you'll find in your kitchen (and don't tell your wife).

**How to Build the Schellert Tool:**

If you have all your material at hand, you can start building the Schellert-Tool.

First you have to cut off a piece with a length of 7cm from the 8mm aluminium tube.

Then cut a slightly shorter piece from the 6mm aluminium tube with a length of about 6.6 cm.

If you want to know, why the second piece have to be shorter than the first one have a closer look on the metal-clamps of the knives.

The clamp is made of two parts, the clamp itself and the serrated little tube around the clamp where the finger will hold the knife (and later your tool). On the bottom side of this tube you'll discover a very little second tube, which is even smaller. This small tube fits into the 8mm tube, so it holds the clamp exactly in the middle of the aluminium handle.

Therefore, the 6mm tube inside the 8mm tube has to be a little shorter to allow some space for this little part from the serrated clamp-tube.

So the exact length of the 6mm aluminium tube piece depends on the length of this little part.

I saw, that this part has a different length on knives from the different manufacturers. So if on your knives this part is shorter, your 6mm tube can be longer. If this part is longer, the 6mm tube has to be shorter.

On pic. 7) you might see a little better, what I mean.

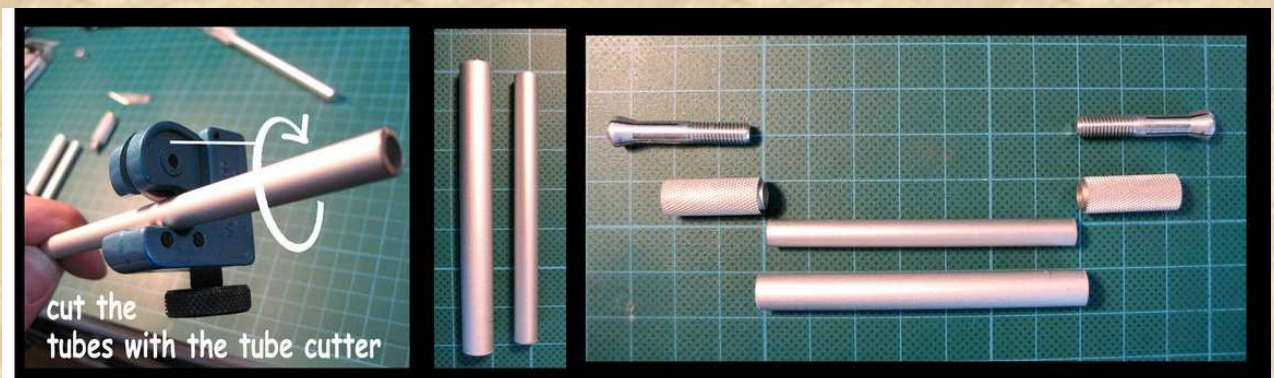
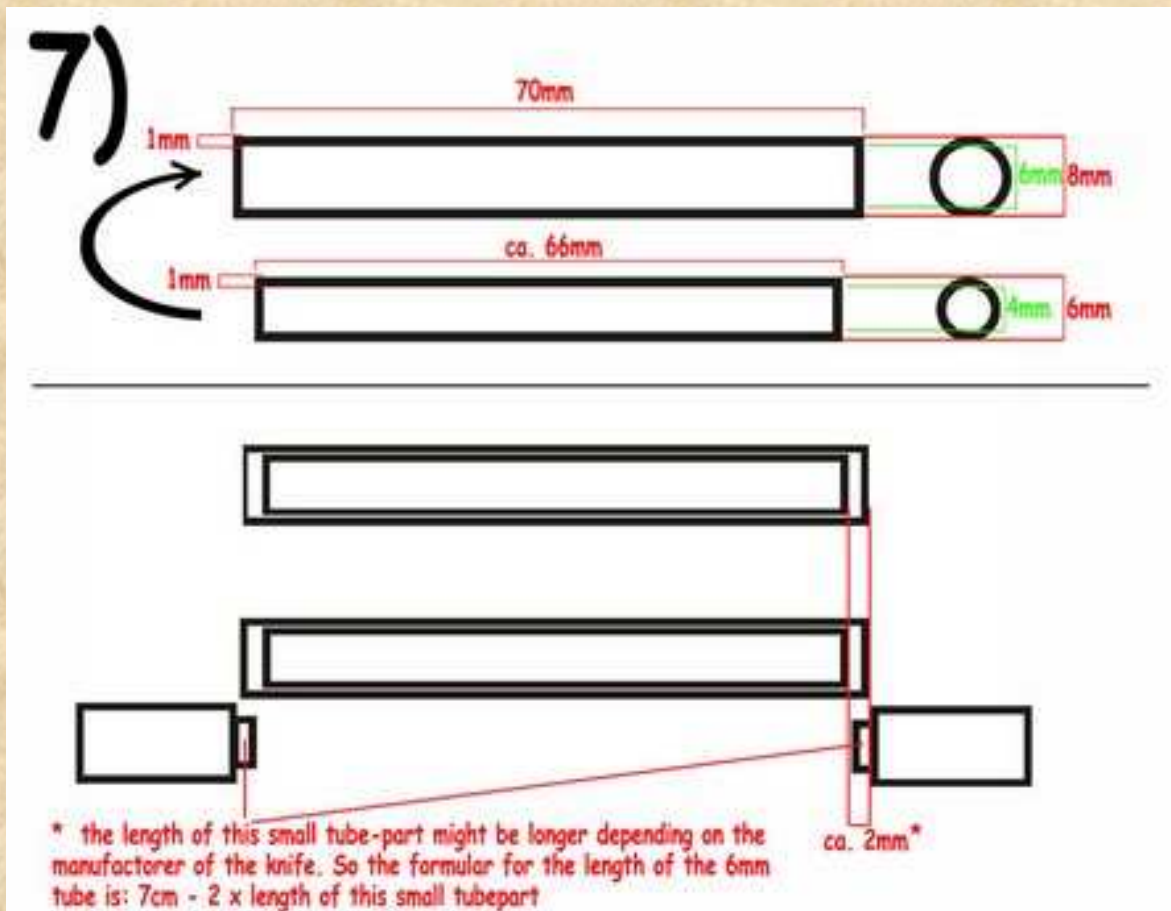

If you got your two tubes with the right length you have to clean the cut and remove all scratches from the cut edges on both tubes.

After that, you have to glue the smaller 6mm tube into the larger 8mm tube by using strong glue that is suitable for metal.

Be aware to place the 6mm tube in a way that leaves enough space on each side of the 8mm tube to fit the little part from the serrated clamp-tube (see pic. 7b).



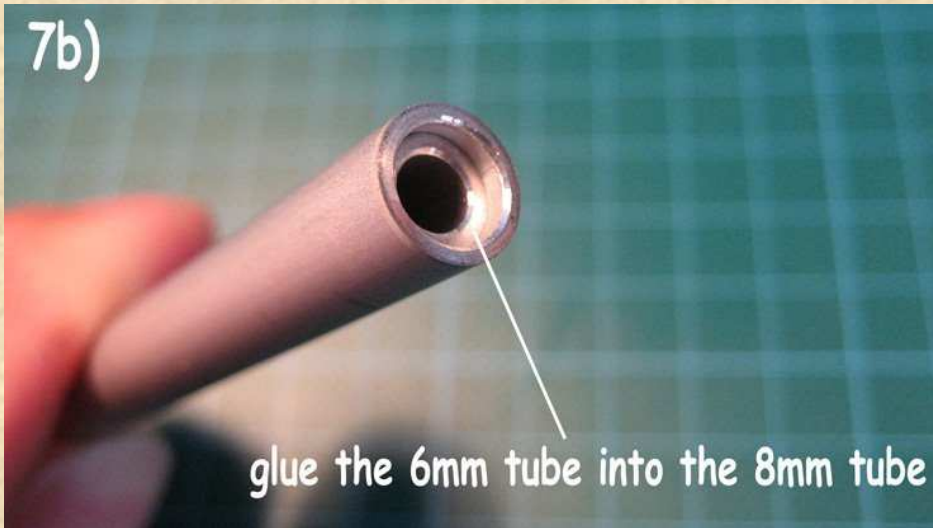

Now give the glue some time to get hard. Be sure, that the glue is completely hardened before going on. I recommend waiting for two days before going on.

If the glue is hardened, it's time to cut the threads into the handle (the two glued tubes). If you never cut a thread before, don't be afraid of it. I also cut my first threads while building this tool. Just don't get frustrated, if the first thread might not come out perfectly. Try again.

If you use the clamps with the M5 thread, you have to widen the handle now. If you use the UNC-10-24-threads, just go on with the next step.

So first you have to fix the handle into the bench vice, like you can see in pic. 8). Then drill carefully with the electrical drilling machine and the 4,2mm drill into each side of the handle. You don't need to widen the inside of the handle over the whole length but just a little longer as needed to take the clamp later. You can hold the clamp beside the handle to see how long the thread of the clamp is and how deep you have to drill.

Before you start drilling, dip the drill a bit into the oil because that will reduce the chance of the drill getting stuck into the handle. Don't rotate the drill too fast but even not to slow. Be very careful with that and make sure, that the handle doesn't rotate with the drill in the bench vice because that would result in very ugly scratches on your handle.

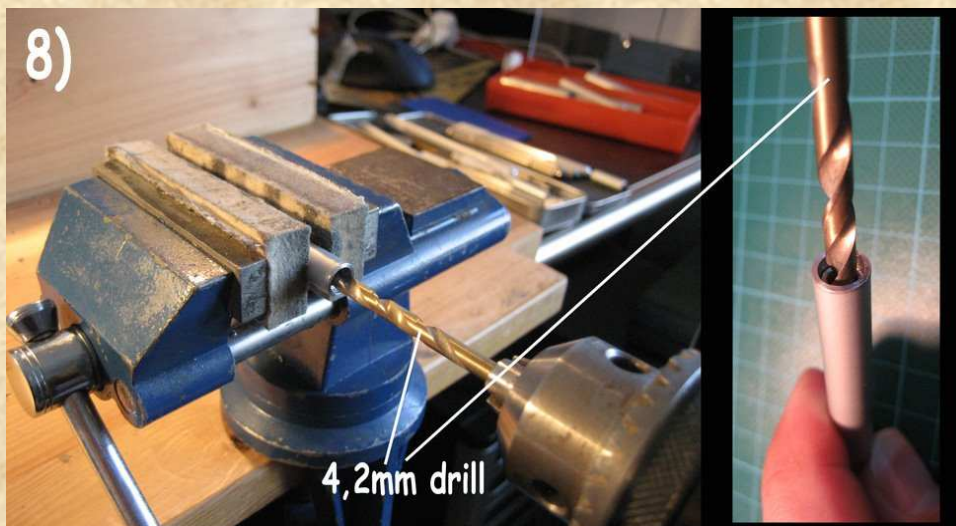

Now you can start cutting the threads. Just fix the handle in the bench vice so it points upwards like in pic. 9. Be sure to use some kind of protection bars (braces) on the bench vice to prevent scratching and damaging the handle. Be sure that it sits as tightly as possible without damaging the tubes. Then dip the thread cutter a little bit into the oil. Don't "oil" too much. A thin skin of oil is enough. And make sure not to drop the oil onto the vice where it holds the handle or you won't get a tight grip anymore and the handle could start to rotate.

If you use the 3-piece thread cutter set, you have to start with the thread cutter (threader) that is marked with one line.

Place the thread cutter into the hole of the handle and slowly start rotating it in clockwise direction. You need nearly no pressure here, just rotating. Be sure –and that is MOST IMPORTANT- that you hold the thread cutter 100% straight and not in an angle to the handles hole. If you don't work precisely here, your thread cutter might stuck after a few mm and later the clamp will not sit straight into the handle and that would be a mess. So work slowly and precise and control the position and the direction of the thread cutter all the time.

Even you need some power to drill (rotate) the thread cutter in, be careful not to turn it with too much power. If the thread cutter seems to get stuck or if it gets suddenly harder to turn, it might indicate that you didn't hold the thread cutter perfectly straight, so control its position. But it can also indicate, that the little metal parts, that you've cut off with the thread cutter are getting too much inside the tube and blocking the thread cutter now a little bit. In this case stop turning the thread cutter and rotate it back in counter clockwise direction for a half or a full turn. When you do so, you might first notice a little resistance when you try to turn the cutter in counter clockwise direction. That's normal and nothing to worry about, so try to turn it a little bit harder, but always keep in mind to control the power you use. Brutality is not an option here. You will see that if you get the right point, suddenly the thread cutter will move as you want and you will also feel in your fingers, that some kind of obstacle has passed.

So after you've rotated the thread cutter back (counter clockwise) for a half or a full turn, and there's no obstacle anymore, just try again to go on with cutting the thread by now turning the thread cutter in clockwise direction again. In most cases now you can go on without getting stuck. If you're getting stuck again, repeat the procedure.

But sometimes even the "half-turn-back-trick" didn't work right and you still get stuck at the same position. If this happens, don't try to go on rotating too hard or it could happen, that the handle starts to rotate into the vice and that would result in ugly scratches on the handle. When getting stuck, remove the thread cutter completely from the handle by turning it into counter clockwise direction (not only a half turn, but get it completely out of the handle this time). You will see then a lot of little aluminium pieces stick to the thread cutter because of the oil. "Clean" the thread cutter by removing all those little metal pieces. You can for example use an old toothbrush or a stiff-bristled brush for that. After removing all these aluminium parts dip the thread cutter once again into the oil and try again to go on with cutting the tread, where you've stopped before.

When you place the thread cutter into the handle again, be sure, that it finds exactly the thread that you've already cut. Otherwise you would start a second thread right from the

start "beside" the already cut thread and that would make the whole thing useless. Just turn the thread cutter slowly into the hole of the handle with no pressure like it would be bolt and nut and the thread cutter will find its way. Now you should be able to go on with the cutting.

The problem with this "getting stuck" appears more often with the single-turn-thread-cutter. If you use this, I recommend not to try doing the whole thread in one turn, but to stop at say halftime and to clean the thread cutter like explained above. With the 3-part-thread-cutting-set you have to face this problem less often.

Go on with cutting the thread until the thread is long (deep) enough. How long it has to be depends on the thread of the knife clamp you use, so hold this part beside your handle to see how deep the thread has to be. To be sure, you should make it a few mm deeper than needed.

If you use the single-turn-thread-cutter, you're done now with this side and you can go on cutting the thread into the other hole of the handle. If you use the 3-part-tread-cutting-set, you have to repeat the procedure with the second cutter, that's the one marked with two lines and finally with the third cutter, that's the one marked with no lines.

The procedure for the other hole of the handle is exactly the same as described above. Just be sure, to avoid getting oil on the safety bars (braces) of the bench vice or on the handle, because that would extremely reduce the bench vices ability to hold the handle tight.



If you got your threads done and if they hold the clamps perfectly straight (try it now), you're nearly done.

You should clean the handle and especially the inside of it to remove all the left aluminium particles and of course all the oil. This is important, because otherwise the remaining oil will get hard, starts to smell (when you use the sunflower oil) and might "glue" the clamps in your tool.

To clean it use a lot of water in combination with liquid dishwashing soap (fluid) and those cotton sticks usually used to clean the ears.

If you have done all that and if you have fixed your clamps to each side of the handle your very own Schellert tool is done.

Ah, sorry one thing left:

If you used the pure aluminium tubes and not the anodized ones, you have to give your handle a good surface. Just remove all those scratches with abrasive paper and polish the handle after that.

To polish the pure aluminium isn't only to achieve a better look, but also to prevent those dark grey stains, that you would find on your hand, if you work with unpolished aluminium.

Now you have to fit your 1mm tool tips into the clamps of the Schellert tool. Any of those clamps from hobby knives I saw were able to hold 1mm tool tips without any modification.

If this would not be the case for the knife clamps you've used and if the space between the "clamp jaws" might be too thin to fit a 1mm tool tip into its cross section, you can widen this cross section by carefully drill in with a 1mm drill. If you have to do this, remove the serrated clamp tube before drilling. Otherwise this little tube might press the "clamp jaws" together while drilling and that would result in a drilled hole, that's much larger than the 1mm you want.

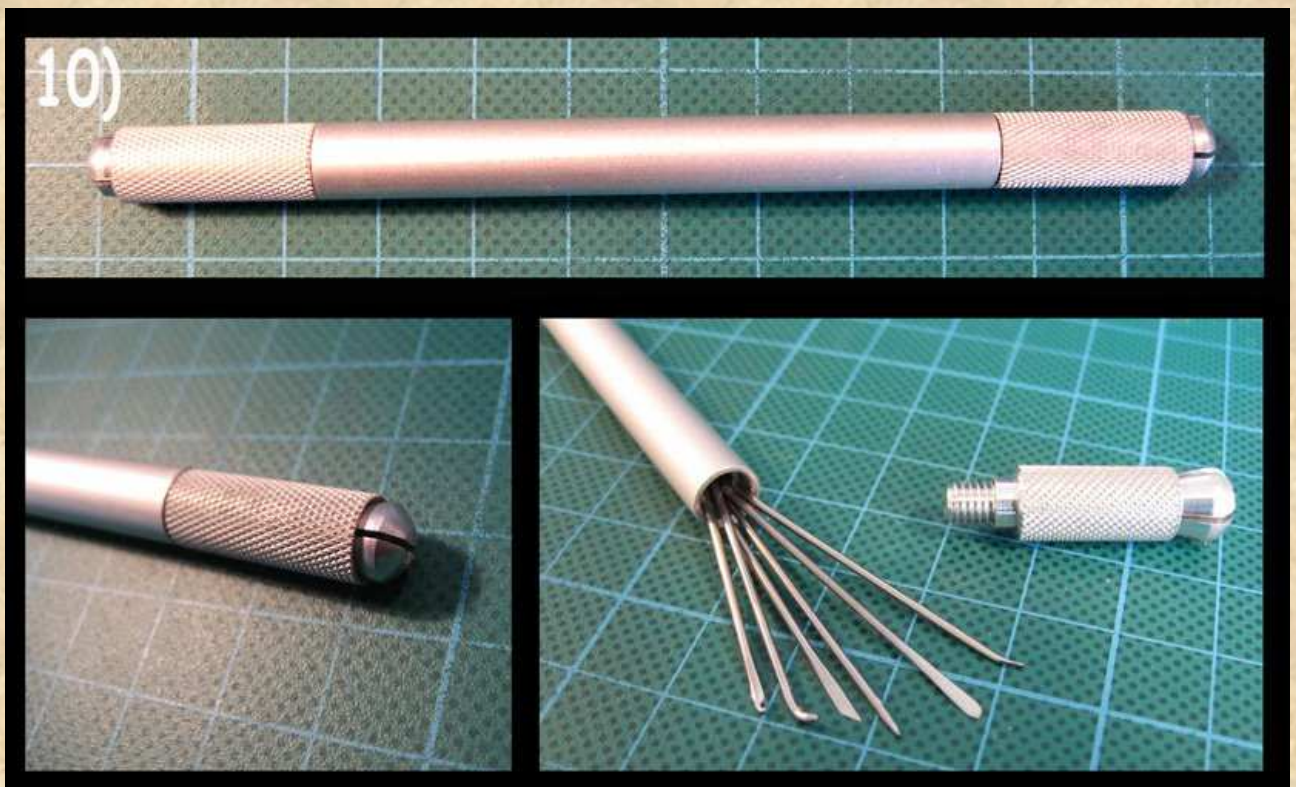

If you unscrew one of the clamps, you can place the 1mm tool tips inside the handle and store it there. There should be enough space to store 6-7 tool tips, maybe more.

And one more thing:

Most of those knives come with safety caps, like the ones you can see on pic. 11).

Don't throw these caps away, because they are ideal to protect your tool tips if you didn't want to store them inside the handle.

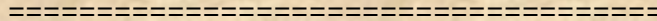
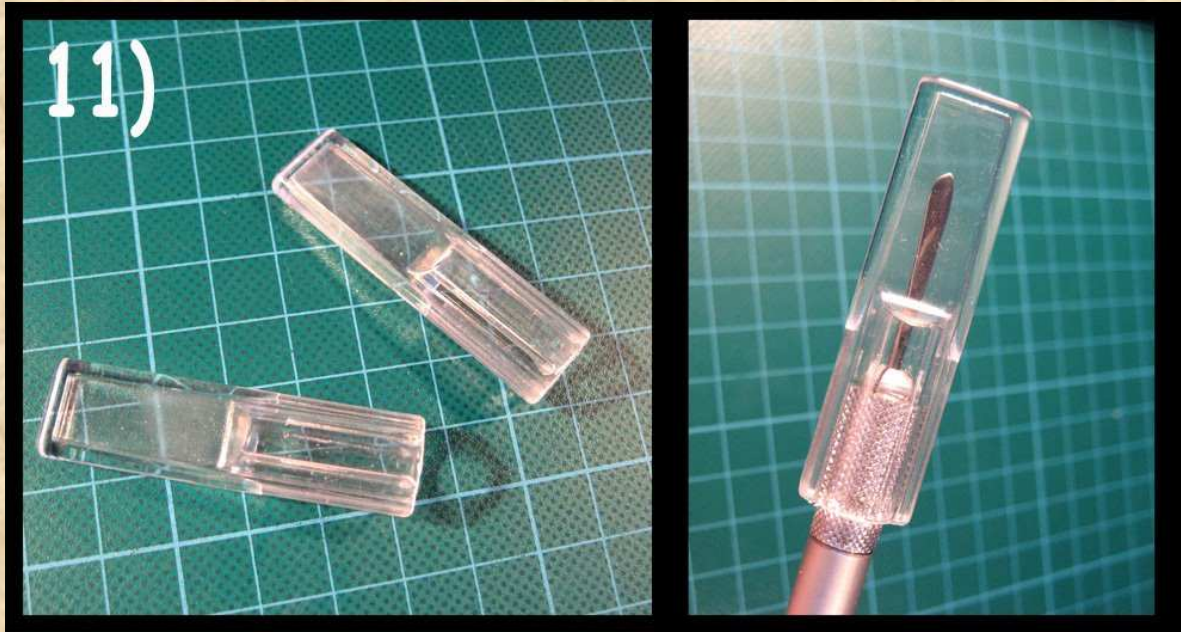

## **AN EASIER WAY TO MAKE THE SCHELLERT TOOL WITHOUT CUTTING THREADS**

I confess, the Schellert Tool is not the simplest tool to build. Especially cutting the threads into an aluminum tube might be challenging even if you own the needed thread cutter and impossible, if you haven't one. So I thought about a way to make this tool easier to build.

The easiest way would be to find somewhere an already cut "thread-piece" that could be used for that. But I had no luck in finding such a pre-fabricated piece until lately:

Now I've found in a hardware store a simple and cheap piece that is ideal for my needs.

In German this thing is called "Messing-Spreizdübel" and the translation into English I found so far is "brass expansion bolt" or "brass straddling dowel". On the next picture you can see this fine little thing.



This brass dowel has an m5-thread and is made for drilled holes of 6 mm diameter.

This is ideal in combination with an aluminum tube with an outer diameter of 8 mm and an inner diameter of 6 mm (material strength: 1 mm), like the one I used for the original Schellert Tool (see page 60).

You don't even need to glue a second smaller tube into 8 mm tube, because the brass dowel will take that part.

So all you have to do is to cut off a piece of the 8/6 mm aluminum tube with a length of about 7.5 cm.

The easiest way to do this is by using a tube cutter that makes perfectly straight cuts (see page 64). Then all you have to do is to put one brass dowel into each side of the tube.

Be sure to push it a few mm below the edge of the aluminum tube. Otherwise the clamp-piece wouldn't fit in later (see next picture).

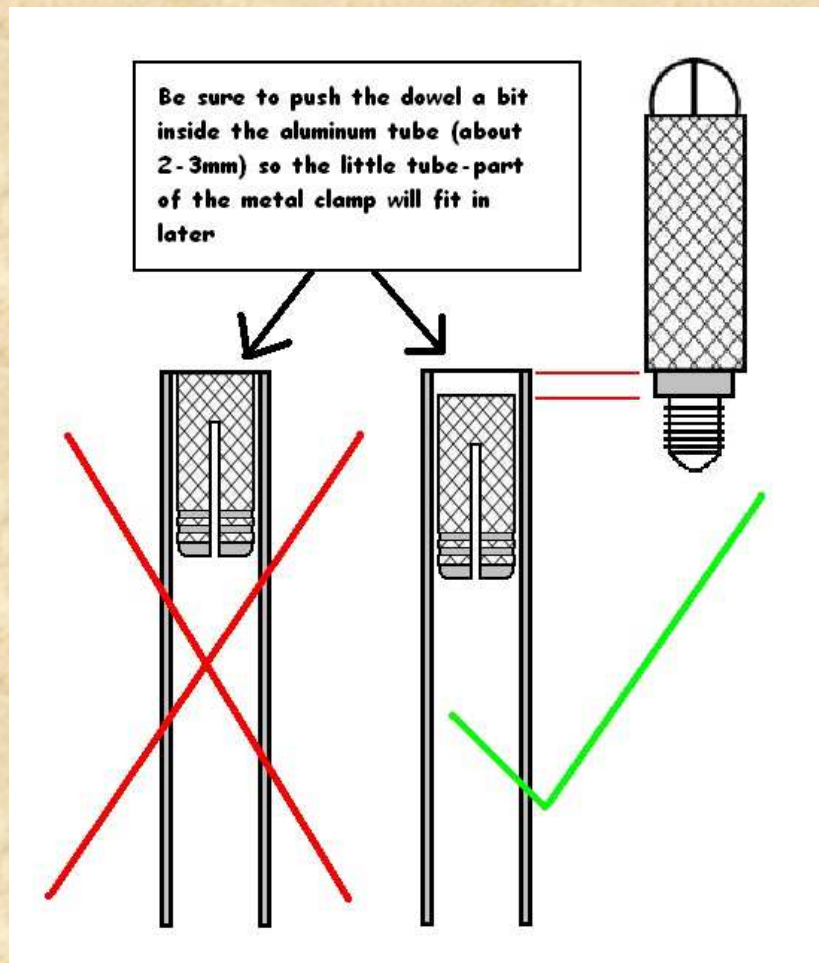

In some cases the brass dowel is a little thicker than the inner diameter of the aluminum tube. In this case you have two options. You can widen the aluminum tube by using a drill of 6.1 or 6.2 mm. The other option, especially if you haven't got those special-sized drills is to grind down the knurled surface of the brass dowel. The easiest way to do this is to fix the brass dowel into a power drill and press it slightly onto a piece of grinding paper while rotating. You can also use a metal file and grind down the brass tube by hand.

To fix the brass dowel into the aluminum tube you have also 2 options: You can simply glue in the brass dowel into the aluminum handle with a good metal glue or you can fix it by using a 5 mm hexagon socket set screw like you can see on the next two pictures.

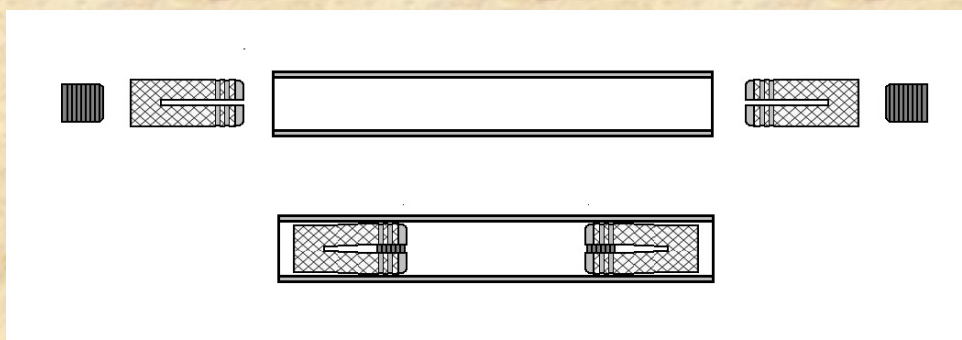



That's all.

All you have to do is to take the clamp-parts of two hobby knives (Martor, ecobra etc...) and screw it into the tube ends.

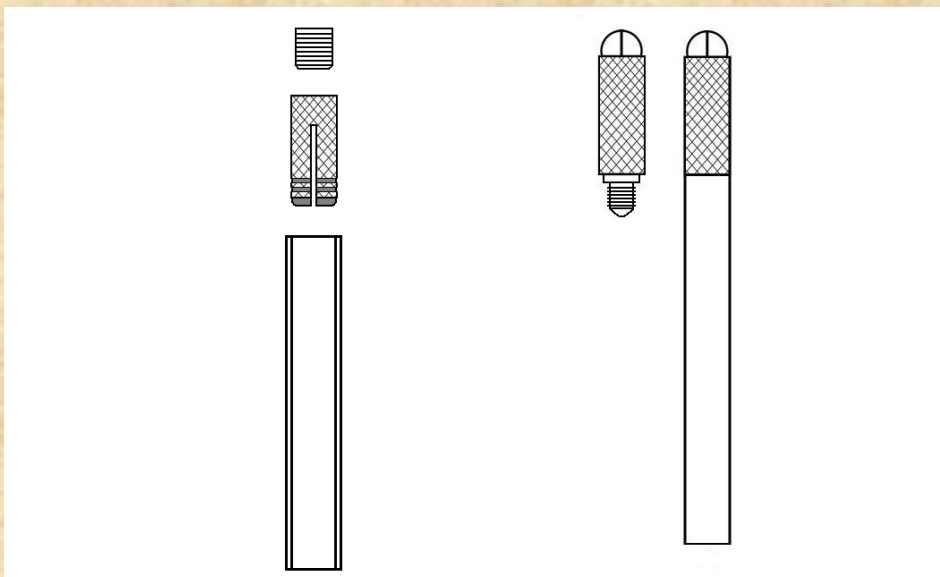





Note: The brass dowels I use have a m5-thread. into the threads of these brass dowels you can only fit the clamp-parts of the hobby knives that have also a m5-thread.

The m5-sized screws and threads are standard in Germany where I'm from. In other countries there are other standards like "unc" in the United States for example.

There are Hobby knives available with m5-threads from Martor and Ecobra for example. I know, that other hobby knives have UNC 10-24 threads, like x-acto and pro-edge, I think (see page 58).

So be sure to use hobby knives with an m5 thread. You can find those knives and also the brass dowels on google/ebay.

---

## THE SCHELLERT TOOL FOR 1,5MM AND 2,0MM TOOL TIPS

The “original” Schellert Tool was made for 1mm tool tips, but it is very easy to build a version for larger tool tips like those made from 1,5mm or 2,0mm Steel wire.

All you have to do is to widen the cross section of the cuts in the clamps with the right drill.

For the knife clamp that I use, I found out that a clamp, that I widened with a 2mm drill will not only hold 2mm tips, but also 1.5mm or 1.6mm tips perfectly.

Remember to remove the small serrated clamp tube before drilling.

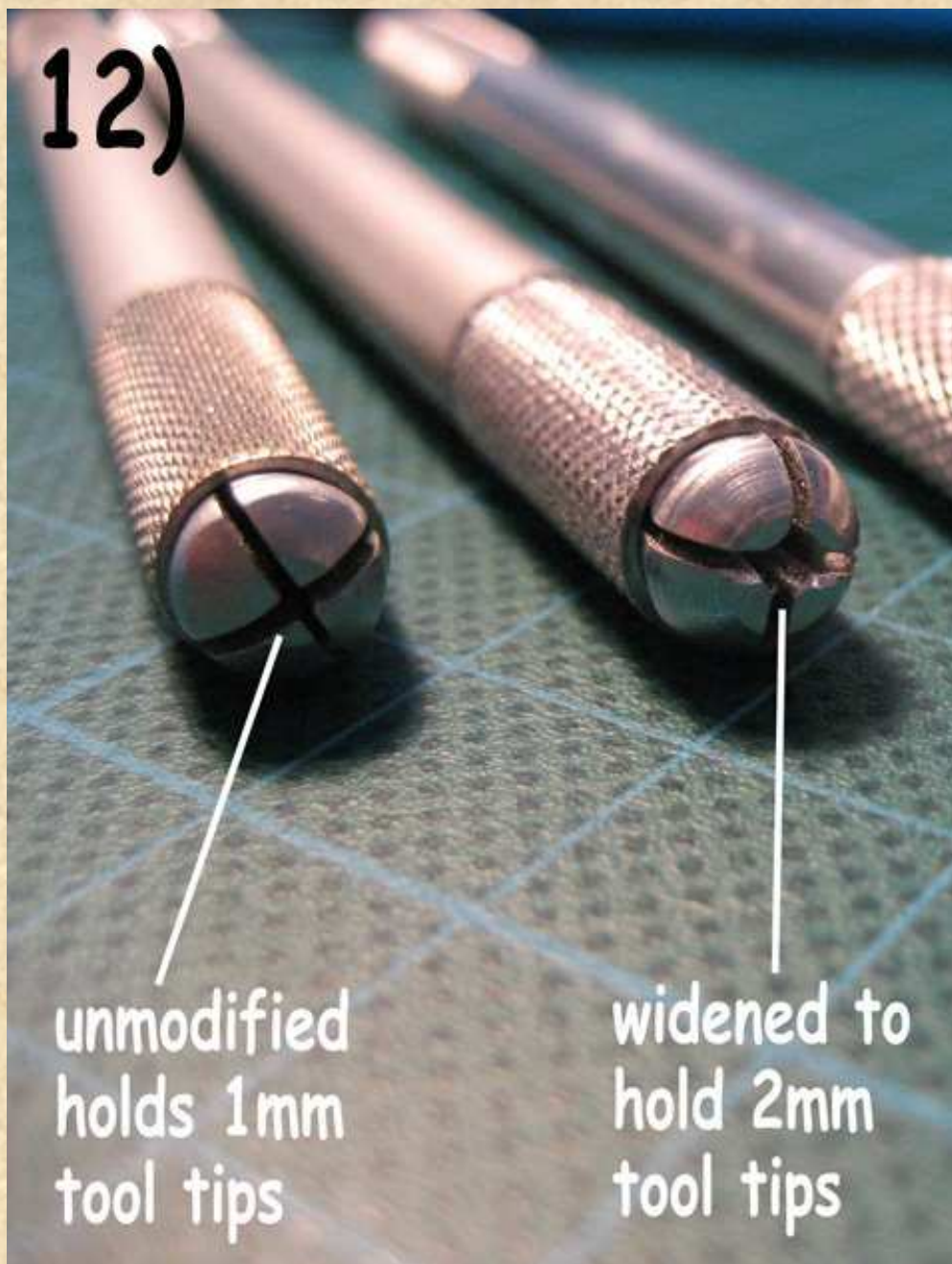

## THE SCHELLERT TOOL FOR 3MM TOOL TIPS

To say it right from the start: I don't recommend to just widening up the cross sections of the clamps to 3mm as I described above for 1,5mm and 2mm. The reason for that is that this would make the clamp itself too thin and it might break.

So the usual clamps from those hobby knives I always talk about in this tutorial are not ideal to make a 3mm tool tip holder from.

But there is a solution. If you search a little bit, you'll find another version of that hobby-knives. These special versions not only have a cross cut on the clamps to hold the blade, but a real cut-out hole, where you also can fit in tool tips with a round diameter. Have a look on pic. 13) to see what I mean.



I found this kind of hobby-knife from the German manufacturers MARTOR and ECOBRA, but if I'm not completely wrong, even X-ACTO produce such a knife.

The knife you can see on pic. 13) is made by MARTOR (it's called "grafix" by the way) and has a clamp, that could hold tools made from 3mm steel wire.

I'm not sure about the other manufacturers, so you have to look for yourself. Unfortunately these knives are more expensive than the usual hobby knives.

With two of those special clamps you can build a Schellert-Tool for 3mm tool tips. There are just some small differences in building it.

Most important is that these knife clamps have a different thread size. The MARTOR Grafix-knife has a 6mm M6-thread. I don't know the thread-sizes from the other manufacturers.

Because of this larger thread size, you'll need a handle with an outer diameter of 8mm and an inner diameter of 5mm, as the base-hole for cutting an m6 thread is 5mm.

So here you can't do the trick with the two aluminium tubes glued together, because the m6-thread is 6mm wide, so the smaller aluminium tube with the 6mm diameter would be too small to cut an m6-thread in.

So what you need here is a single aluminium tube with an outer diameter of 8mm and an inner diameter of 5mm (material strength: 1,5mm). Unfortunately it's not easy to find aluminium tubes with that size. At least it took quite a long time for me google-ing around until I found someone here in Germany who sells it. Maybe it's easier in the country where you live.

If you can't find this size of aluminium tubes but you desperately want a Schellert-Tool for 3mm tool tips, there's one other thing, you can do:

You can cut off the handle of that special knife at the backside, so the handle is about 6-7cm long. I mean the opposite part of the side that holds the clamp. What you have to do then is to drill a 5mm wide hole into the cut side of the handle. The problem is that this hole has to be placed exactly in the centre point. This isn't quite easy to achieve.

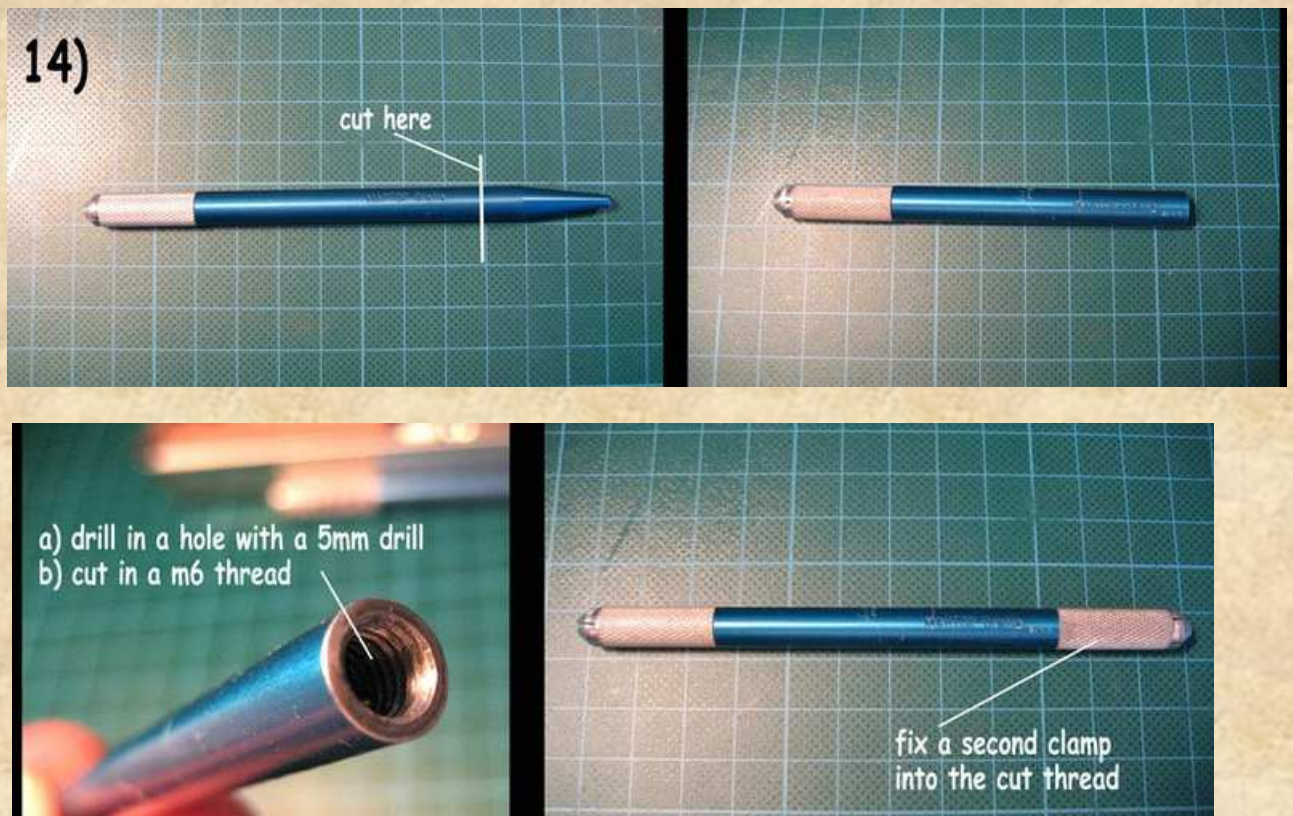

So first you have to find exact position of the centre point first. There's a trick you can: Place the handle into an electrical drilling machine (power drill) and let it rotate (not too fast). Then touch slightly the cut end of the handle with a pointed pencil. When the lead of the pencil leaves a circle, you are not in the middle, when it leaves just a point you are exactly in the middle (centre point). This point marks your centre point now and this is where you have to drill in.

Take a thin drill (like 1mm or 2mm) now and drill a “guiding hole” exactly in the centre point. After that you can try to drill in the 5mm hole and hope, that the “guiding-hole” keeps your 5mm drill exactly in the centre. I tried this several times and sometimes it went fine and sometimes it did not. Maybe you know a professional metal worker, who has machines to do this kind of work more precisely.

When you succeed in getting the hole in, you just have to cut the m6-thread. The good thing is that you only have to cut one thread, because the other is already there. Of course the handle of this tool isn't hollowed, so you can't store the tool tips in.

But this isn't a problem, because this tool-version is for 3mm tool tips and those are too big anyway to fit into that handle even if it would be hollowed (except for a straight needle maybe).

On the following picture you can see all three sizes of the Schellert tool

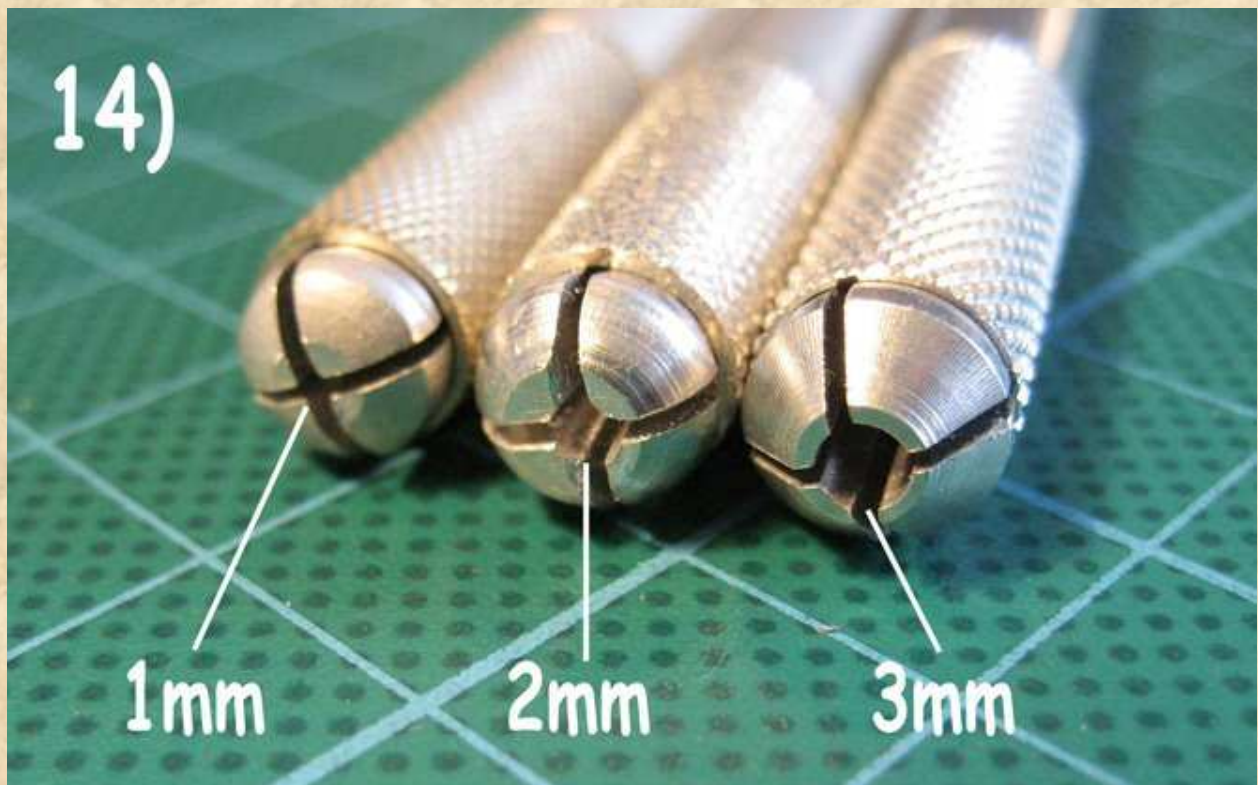

So that's all about the Schellert-Tool. I hope you'll like this tool.

In the next chapter I'll tell you about an “easy way” to build a tool that is quite similar to the original Schellert-tool.

## THE SCHELLERT TOOL – the easy way

In the last tutorial I explained, how to build the original Schellert-Tool.

I can imagine, that some of you would like to have such a tool, but don't want to do all those thread cutting things. After a search on the internet I found a solution for those of you.

You can make a version of the Schellert-Tool just by using a special kind of pin vice (or pin vise if you are from the US) with only minimal modifications. And that's how to do it:

First you need the right pin vice and that's where the magic is. Most pin vices around are not ideal for that job because of the way they are built.

Nearly all pin vices work by screwing a nut-like part over a metal-clamp, so that it is pressed together and hold a drill or another tool this way.

This kind of construction results in a tool that is too thick for using it as a handle for sculpting tool tips and the nut-like part is often an obstacle in the hand.

On the following picture you can see such a typical kind of pin vice:



But I found some pin vices that work with a different technique.

On these pin vices, there is a clamp with a thread that drags itself inside the handle while screwing it and closing the clamp-jaws this way.

In fact, that's the same technique as found on the hobby-knives, the original Schellert-Tool is build with.

These pin vices are two-sided and each side can hold tool tips with different sizes.

On the following picture you can see the two different pin vice systems:

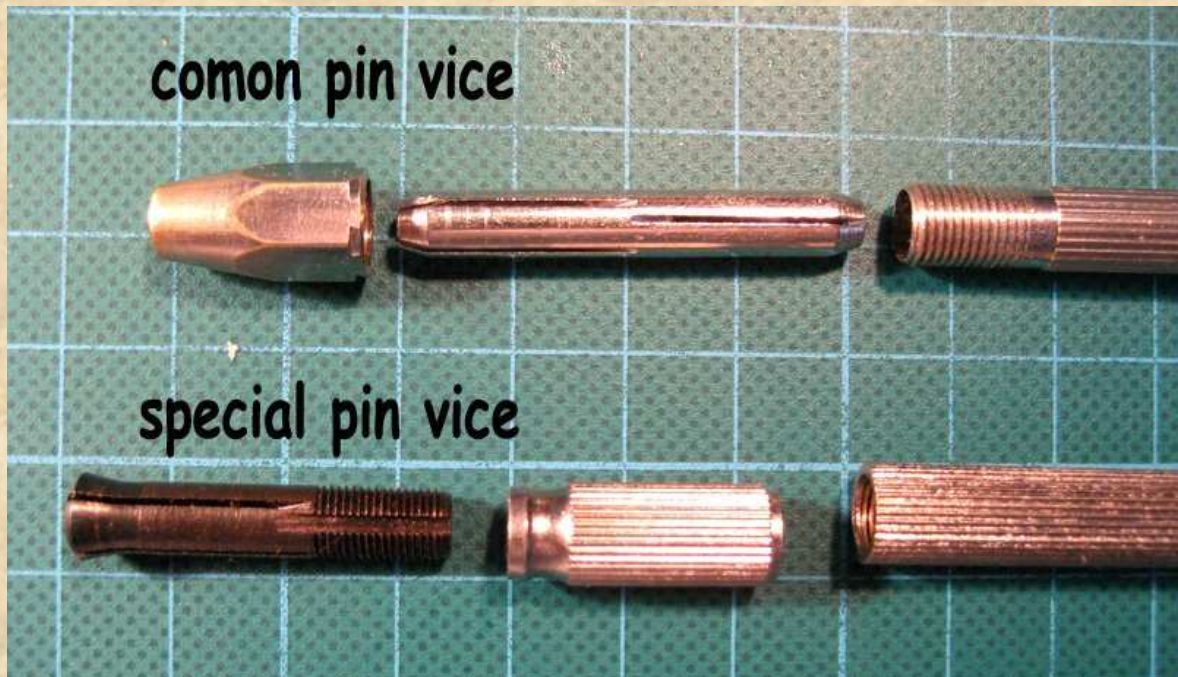

For my German speaking readers: The German word for these tools is “Stiftenklöbchen” or “Reibahlenhalter”.

I found two different versions of this kind of pin vices, but I guess, there are more out there.

The first (**type 1**) I found on eBay (it comes from the US) and costs about 3 EUROS.

It could hold 1mm tool tips on one side and up to 2mm tool tips on the other.

This pin vice is a little shorter but with a slightly thicker handle then the other pin vice.

The other pin vice (**type 2**) I’ve got from a German shop for jeweller tools.

This one holds 1mm tools on the one side and up to 3mm tool tips on the other.

The pin vice is a little longer than the one from eBay, but the handle is thinner. This one cost about 4.20 EUROS.

**type 1:**



**type 2:**



So I recommend getting two of this pin vices (I mean two of the same type; don't mix the types because the threads could be incompatible) and change one clamp of each pin vice, so you have two pin vices with the same sized clamp on each side.

Of course if you want a tool with different clamp sizes on each end, you don't have to change the clamps.

I found that the screw able part of the pin vice were the finger holds it is too thick for getting a good grip for sculpting, so I replaced it with a 2cm long brass tube with an outer diameter of 8mm and an inner diameter of about 7mm (material strength: 0,5mm).

You can find those kinds of brass tubes in hobby- and model craft stores and also in hardware stores and building centres.



I recommend using a tube-cutting tool (see the former chapter about the Schellert-Tool) for cutting the brass tubes because with it you will always get a clean and straight cut.

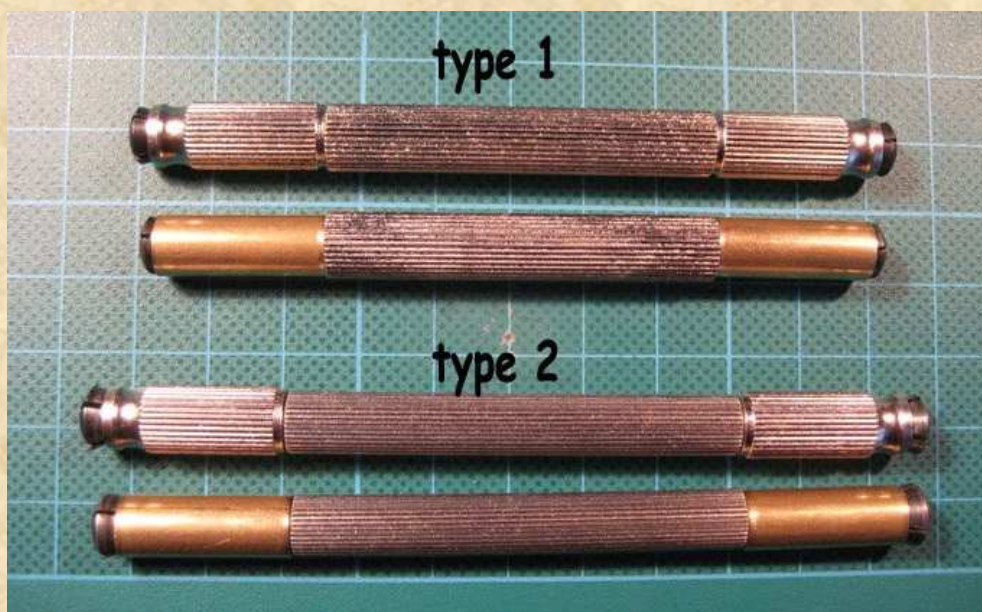

Believe it or not, but that's all. You now have two Schellert-Tools, one for 1 mm tool tips and one for 2 mm tool tips (or 3 mm tooltips – depending on the kind of pin vice you've used).

Maybe the shorter of this pin vices is a bit too short to store the tool tips with 4 cm length, but it's just a matter of mm. If so, just shorten your tool tips a few mm and they will fit in.

The clear advantage of this Schellert-Tool version is that it's easy to build, you don't need complicated tools to build it and it's quite cheap.

The only downside of this kind of Schellert-Tool is that it is heavier than the original version, because it is made of plated brass (usually) and that the "grip-tubes" are not serrated (not such a good grip). But if you can live with that, that's your tool.

So I think, I haven't promised too much. This Schellert-Tool was really the easy way, no?

The basic idea behind the Schellert-Tool is that you can change the tool tips fast. But this is not always a need. In reverse it could be boring, if you have to change the tool tips all the times while sculpting. So maybe soon you want to have at least those tool tips that you permanently work with to be always available at hand without having to change anything.

Because of that I thought about a kind of two sided handles, where the tool tips will be fixed and don't have to be changed. About this handles I will tell you in the next chapter.

---

## HANDLES

### TOOL TIP HANDLES

Until now, I've talked a lot about different kinds of sculpting tool tips and explained the Pencil-Tool and the Schellert-Tool as handles for those tool tips. While the Pencil-Tool and the Schellert-Tool have the advantage that the tooltips can be changed easily and fast, this might sometimes be a disadvantage. After working with your sculpting tools for a while, I am sure you will find your preferred tool tips and you will do 75 % of the sculpting work just with a few of them. In this case, you will surely want to have these preferred tools always at hand, without having to change tool tips permanently.

Therefore, I will explain in this tutorial how to do handles in which the tool tips can be fixed permanently.

Maybe you might think there is not much to talk about. Just take a piece of wood, drill in a hole, glue the tool tip inside the hole and that's it. You are right. If you are happy with a simple handle, just save your time and just do it like that. I will also explain how to do such a "simple" handle.

But maybe you have already spent quite a lot of time in forging very fine sculpting tips and you didn't want to see all your work spoiled by mounting them on crappy handles. If that's what you think, I will show you in the following tutorial some ways to do a little bit more sophisticated handles.

### GENERAL ASPECTS

Generally, I create nearly all of my handles as two-sided-handles. That's not a must. You can also do handles with just one tip and this might be indicated with very sharp and / or pointed tool tips to reduce the risk of injury. But in general, I prefer less tools lying around on my work desk while sculpting to keep my workspace clear arranged. So having two-sided tools means half as much tools on your table.

Regarding profile and diameter of the tool handles, I found out, that a rod with a round profile and a diameter of 8mm works best for me. That's the same diameter as the Schellert-Tool (and these hobby knives like x-acto or martor) has. Beside the fact that I can hold it quite well in my hand it has the advantage, that "8mm" seems to be a kind of standard-size, so it would be easier to find material with that diameter in hardware stores. Alternatively you could use 6mm (also a standard-size), but I recommend that only for small tool tips.

Regarding the length of the handle, I found out, that 10cm (without the tool tips) is a good length for me. If you've got the hands of an elf, maybe a shorter one will do better but if your hands are more troll-style even a little bit longer might be adequate.

As material for the handles, there are two good options (for me): wood of aluminium.

Plastic is something, I didn't really like for my tool handles. Some sculptors also use brass, but a handle with 8mm diameter made of brass could sometimes be a little heavy. So I recommend using brass-tubes only for handles with smaller diameters, like the one, I will explain later.

### Wood:

I tried beech-, walnut- and oak-wood for handles by now and all work well (pic. 1). Beech has the advantage that it can be found in poles of 1m length and 8mm diameter in nearly every hardware store or building centre (at least in Germany). Walnut has a beautiful dark brown colour and looks really nice if you give it a finish with clear varnish. Oak has a quite interesting surface structure if you give it a clear varnish and it is quite hard. Unfortunately, 8mm-poles of walnut- or oak-wood are hard to find. In Germany I found this shop: <http://www.rundstab.de/> for that. If you are not from Germany, try Google to find the wood you need.



### Aluminium:

Aluminium tubes with 8mm and 6mm diameters can be found in most hardware stores or building centres, as I told before (see: "The Schellert-Tool").

As I already mentioned, there are two qualities available, the untreated "pure" aluminium and the aluminium with the anodized surface. Handles made of untreated aluminium tubes have to be polished finally. A not polished oxidised aluminium surface would leave dark grey marks on your hand. The surface of anodized aluminium on the other hand is just fine, so you can take it as it is without the need to polish or modify it.

## SIMPLE HANDLES WITH GLUED IN TOOL TIPS – Version 1

A very simple handle with glued in tool tips could be made like that:

Take a 10 cm long piece of a wood pole with 8mm diameter for the handle.

I recommend here not to glue the tool tip directly into the wood, but to first glue in a little brass-tube and then to glue the tool tip into the brass tube. By doing this, you'll give the tool a better steadiness.

Drill in holes for the tool tips on both sides of the wood. The drill should have the diameter of the brass tube. So for example if you want a tool with 2mm sculpting tips, I recommend an brass-tube with an outer diameter of 3mm and an inner diameter of 2mm (material strength: 0,5cm).

You have to be sure, that your 2mm tool tip will fit inside this tube (sometimes they are a little smaller than 2mm). If it is too small, you can widen it carefully with a drill or a needle file.

If you want to have a handle for 1mm tool tips, just use a 3mm brass tube with an inner diameter of 1mm.

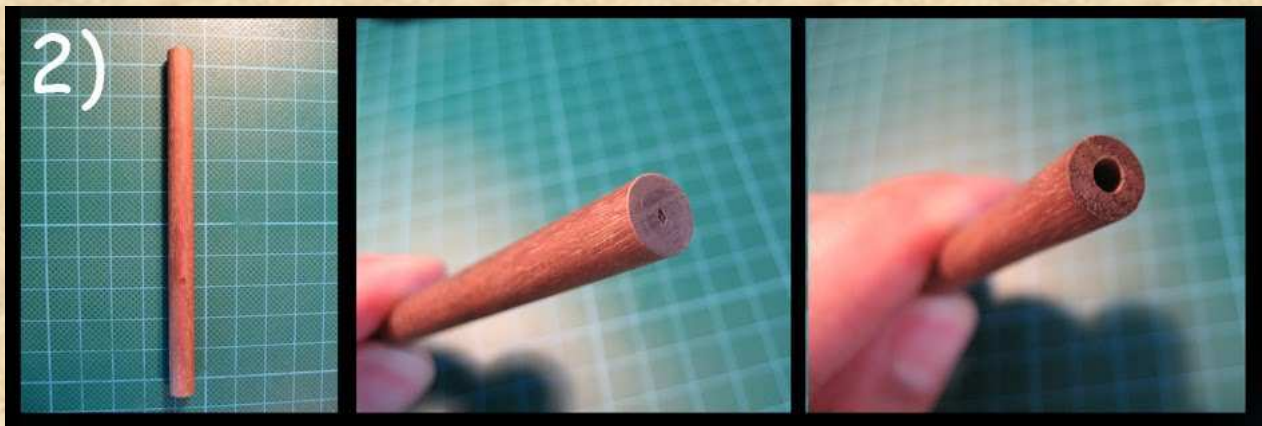

A surprisingly difficult part is to drill the hole into the wooden handle exactly centred and straight. Maybe you should drill in a guiding hole with a smaller drill first.

I don't want to talk too much about this point here, but later I will explain a little tool, I build for myself, that helps to drill in such centred holes quite easily.

After drilling the holes in, just bevel or round the two ends of the wooden handle.

A quite easy way for doing that is to fix the handle into the power drill. Then while rotating it inside the power drill, grind off the wood with the rotary tool and a grinding tool that is suitable for wood.

Keep an eye on the rotating directions of the power drill and the rotary tool to make sure that they didn't "neutralise" each other (pic. 3).

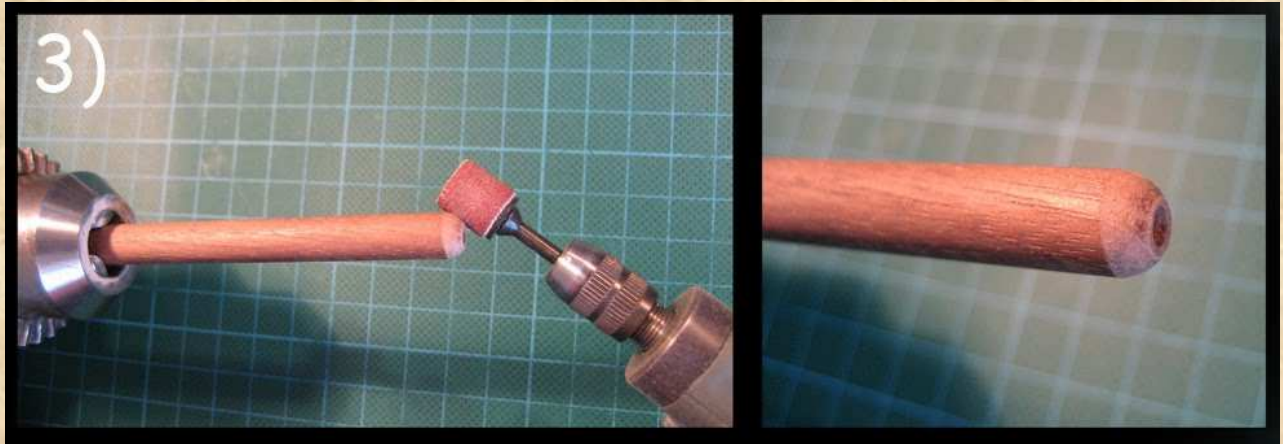

If you got a nicely bevelled handle, you have to give it a good surface by using fine abrasive paper.

Then you have to glue in the two brass tubes into the holes on each side of the handle. I prefer to let the tubes poke out a few mm (pic. 3a)

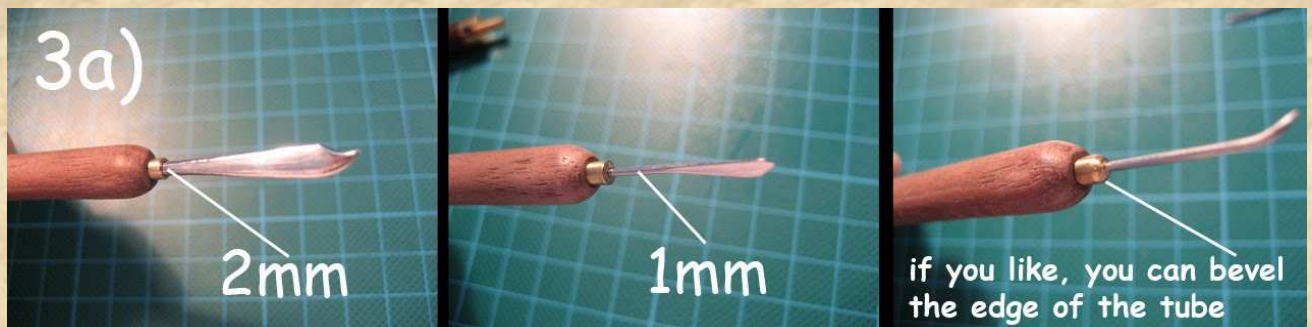

Then you should varnish the handle. Be sure to take the right varnish for that.

As you will hold the tool in your hand, the varnish should be quite hard. You should ask someone at the hardware store / building centre, or wherever you buy your varnish about a varnish, that can be used for that.

If you want to do it well, give your handle at least two layers of varnish, first an undercoat / primer and then a second layer of varnish. You can also do the first layer with varnish that you've thinned a bit with the right paint thinner.

After the first layer of varnish / primer has dried, make sure to abrade / grind it with very fine abrasive paper before doing the second layer.

As an alternative to the abrasive paper, you can also use very fine steel wool.

When you work with the varnish, be sure not to clog the hole with it.

On the following pic. 4) you can see the difference between plain and varnished walnut.



After the varnish has dried, all that's left to do now is to glue in a tool tip on each side.

For that you should get a good metal glue (ask at the building centre). A two-part epoxy glue might be adequate here (pic. 5).



The handles on the picture above are not varnished.

## SIMPLE HANDLES WITH GLUED IN TOOL TIPS – Version 2

Some people prefer tool handles with smaller diameters, especially for very fine tool tips.

For those here is a way to make such a handle with brass tubes:

It's quite the same as the handle I've explained before, but instead of using an 8mm wooden pole, you'll take a brass tube with a smaller diameter.

So basically it's just a brass tube with two smaller brass tubes inside at the ends to reduce the diameter of the tube to that of the sculpting tips diameter.

I guess, for a slim handle a diameter of 4 mm would be a good choice (if you want 6 mm aluminium might be a better choice than brass because of the weight).

You can find brass tubes with different material strength. As I mentioned before, I don't like if the tools are too heavy, so I recommend using brass tubes with a material strength of 0.5 mm and not the one with 1mm diameter for the handles.

The material strength of the smaller "insert" tubes depends on the diameter of the tool tips, you want to place in.

Here's a chart of a useful combination of the tubes diameters:

<b>handle-tube</b>	<b>insert tube</b>	<b>makes a handle for:</b>
<small>outer diameter / inner diameter</small>	<small>outer diameter / inner diameter</small>	
<b>4 / 3</b>	<b>3 / 1</b>	<b>1 mm tool tips</b>
<b>4 / 3</b>	<b>3 / 2</b>	<b>2 mm tool tips</b>
<b>6* / 4*</b>	<b>4 / 2</b>	<b>2 mm tool tips</b>
<b>6* / 4*</b>	<b>4 / 3</b>	<b>3 mm tool tips</b>

\* Because of the weight use an aluminium tube instead of brass for the outer handle tube

To build such a handle, take a 4mm brass tube with a length of about 10cm.

Then cut two short pieces of the 3mm brass tubes for the "insert"-tube. In most cases a length of 1cm -1.5cm will do (remember: don't make it too long because of the weight).

After that, just glue the two insert-tubes with the non-bevelled side into each end of the handle-tube (pic. 6a ).



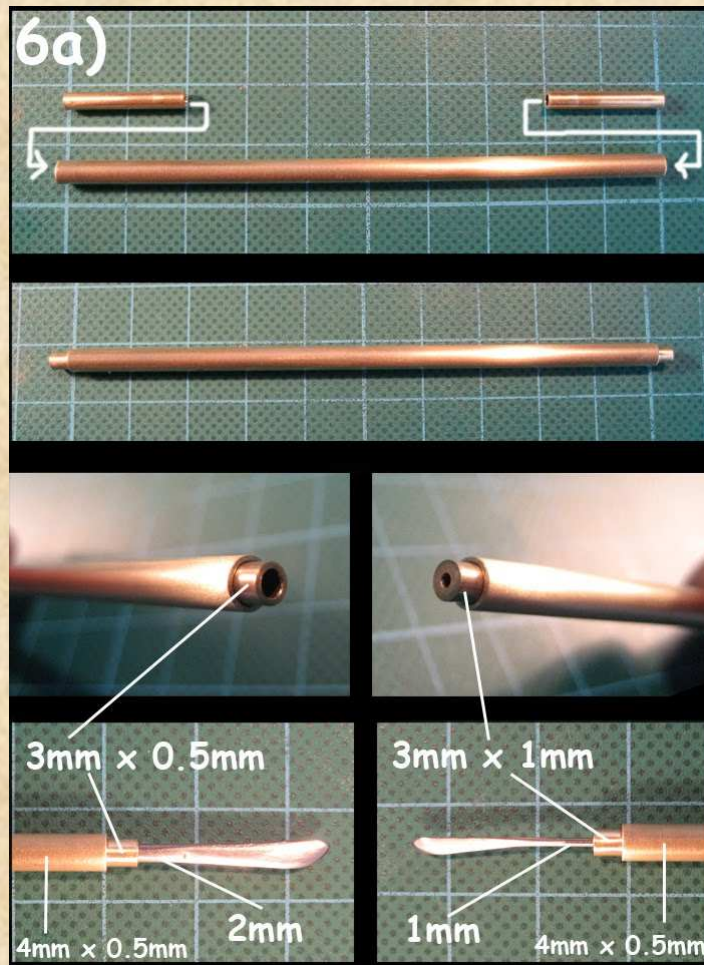

You can also make a handle with 6 mm diameter with a combination of aluminium and brass tubes that have to be glued together like you can see on pic. 6b).

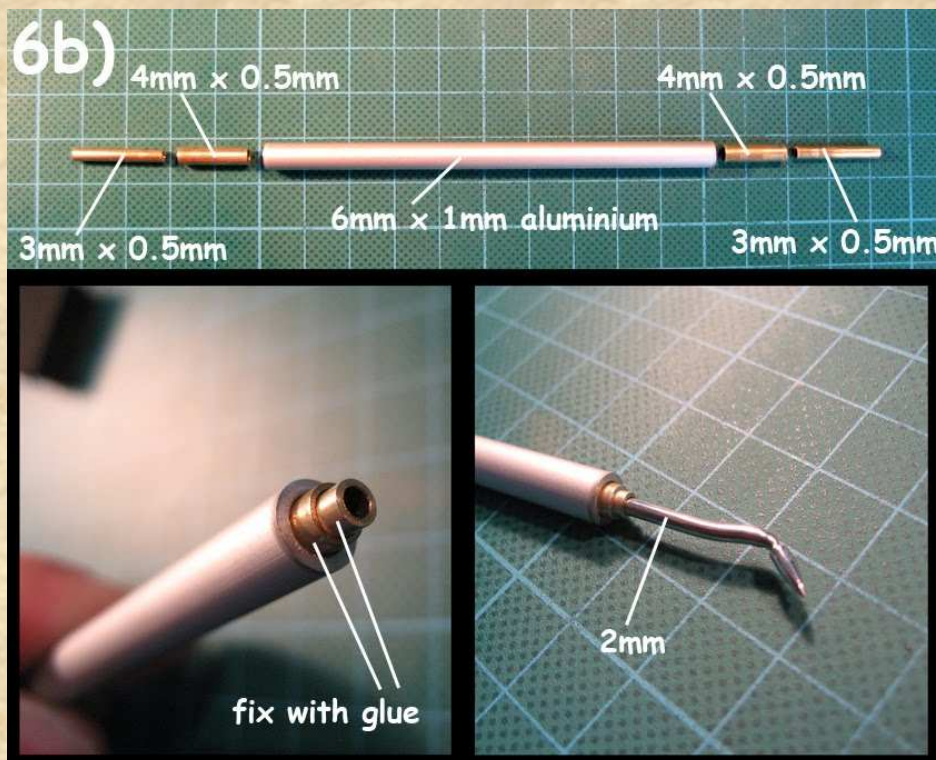

Finally glue in a tooltip in the hole of each insert-tube.

If the surface of the tool tip is too even and you're afraid, that the glue might not hold it in place, you can roughen the part that has to be glued carefully with a file of the cutting wheel in the rotary tool. Be careful not to damage the tool tip.

That's it.

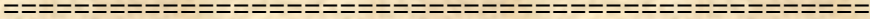

## HANDLES - SCHELLERT STANDARD HANDLE

### THE SCHELLERT STANDARD TOOL HANDLE

While I've explained the building process of a simple handle before, personally I like to do my handles in a little bit different way. First I didn't like to glue my tooltips into the handle, because then they are fixed for ever. If so, I wouldn't be able to change the tool tip, to give a two sided tool another tool-tip-combination for example. Even the length of the tool tip can't be adjusted anymore, if you took glue to fix it. So I found another way to do handles in which the tool tips are fixed with a little headless screw. You have to use a small hex-wrench to do this.

It looks like this.



The trick about making this handle is a special kind of adjusting ring that I found via internet (pic 10.). This nice little thing is an adjusting ring made of brass with a socket to fix it into a hole.



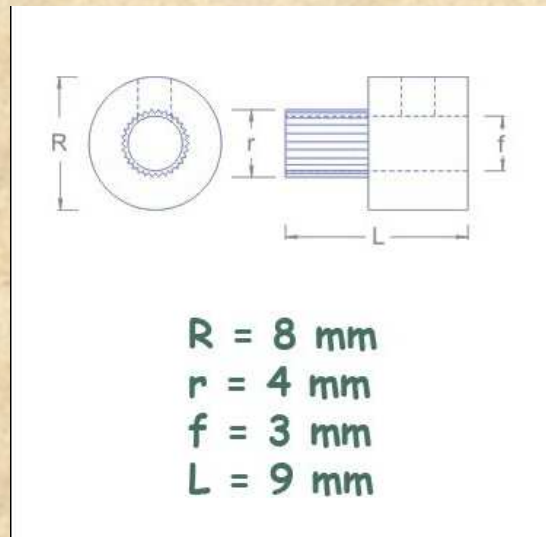

You can order this adjusting ring from this German reseller:  
<http://www.schiffsmodellbau-onlineshop.de>

I'm not sure if it can be found somewhere else. At least I couldn't find it elsewhere.

For those who can't get these adjusting rings, I will explain later, how you can use ordinary adjusting rings and a brass tube as an alternative.

So I started my handle with a piece of wood from the 8mm wooden pole. Because one of these adjusting rings will be added to each side of the handle later, I cut the wood-piece not at 10 cm length, but a little shorter (10cm - 2 x (length of the adjusting ring)), say 9cm this time.

Then I have to drill in the hole into both sides of the handle. As the socket of the adjusting rings has an outer diameter of 4 mm, the hole has to be 4mm wide (pic. 11).

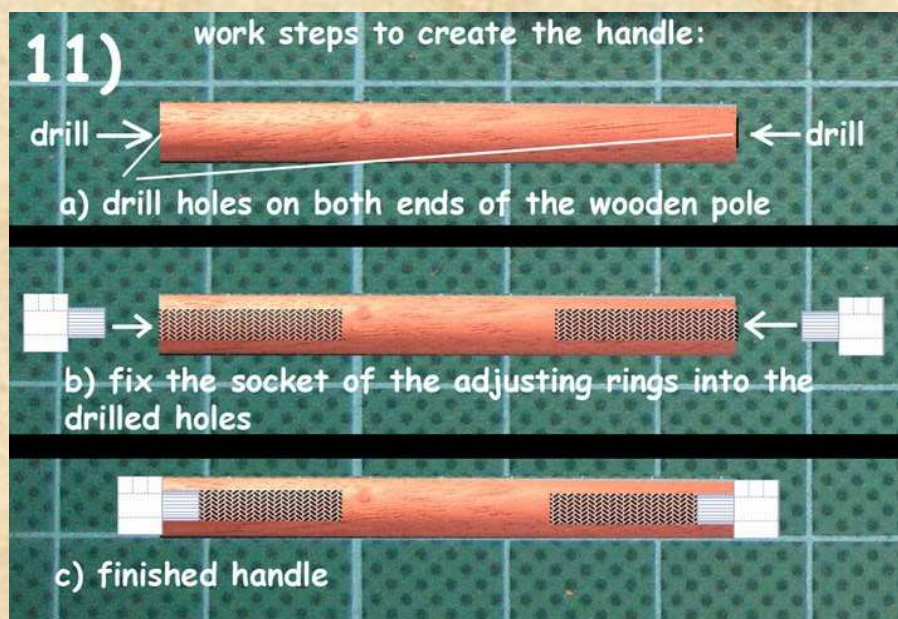

Now the little tool, I've talked about before, comes into play. I've combined an aluminium tube and a brass tube to form a drilling-aid. With this aid, you can place and keep the drill exactly in the centre point of the tool handle while drilling.

So it's a matter of seconds to make a perfectly placed hole. The pictures below (pic. 12a and 12b) explain how this drilling aid is made.

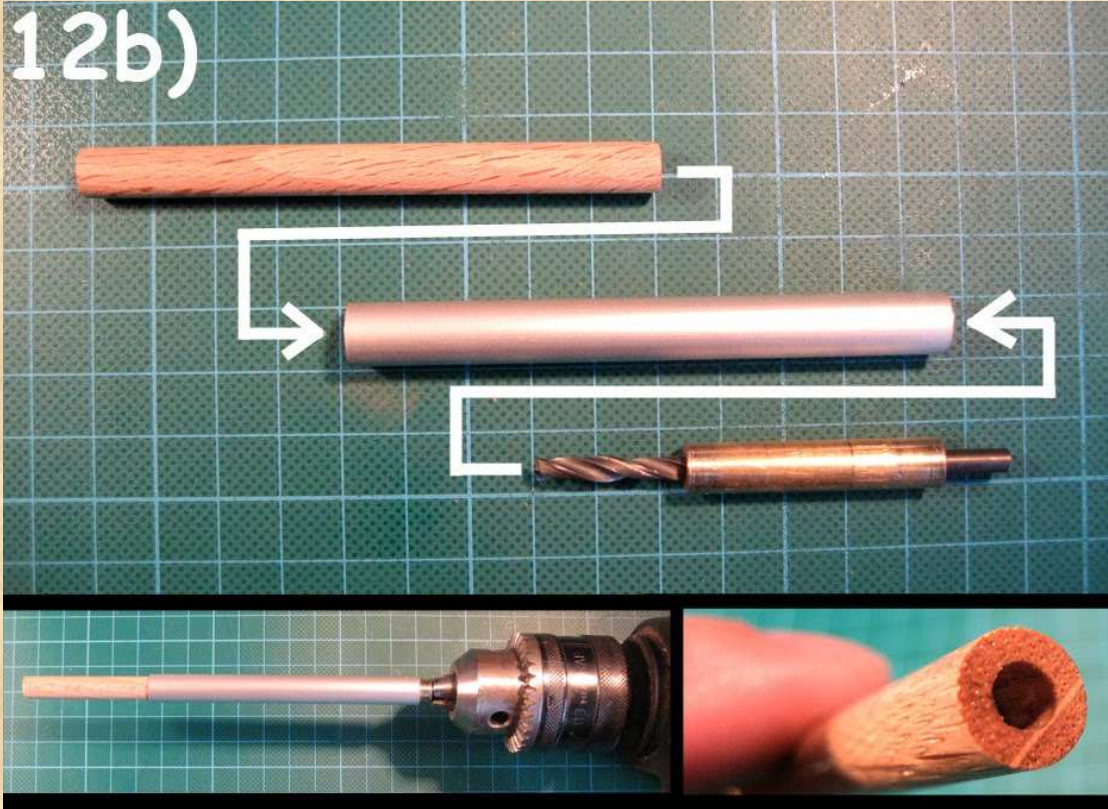
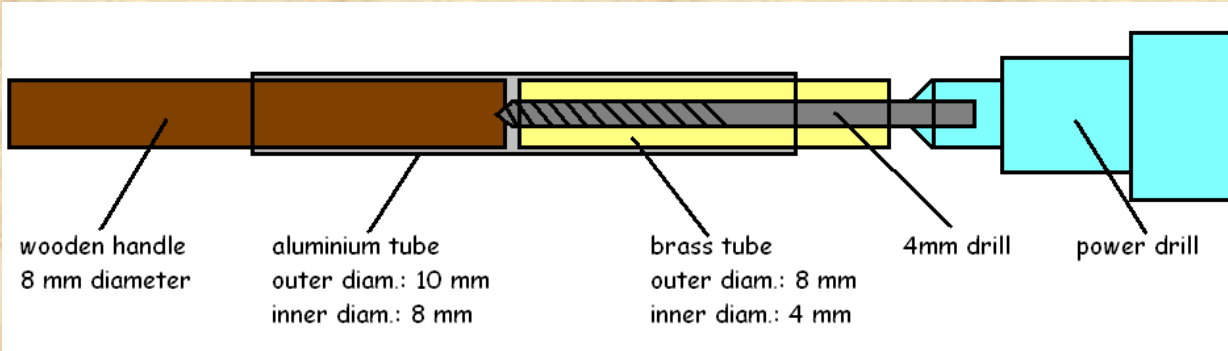

Obviously, the final hole has to be as deep (or a little deeper to stay flexible) as the tool tip will stuck into it.

But here you've got two options:

The **first option** is the simpler one. You can see it on the following pic. 12c):

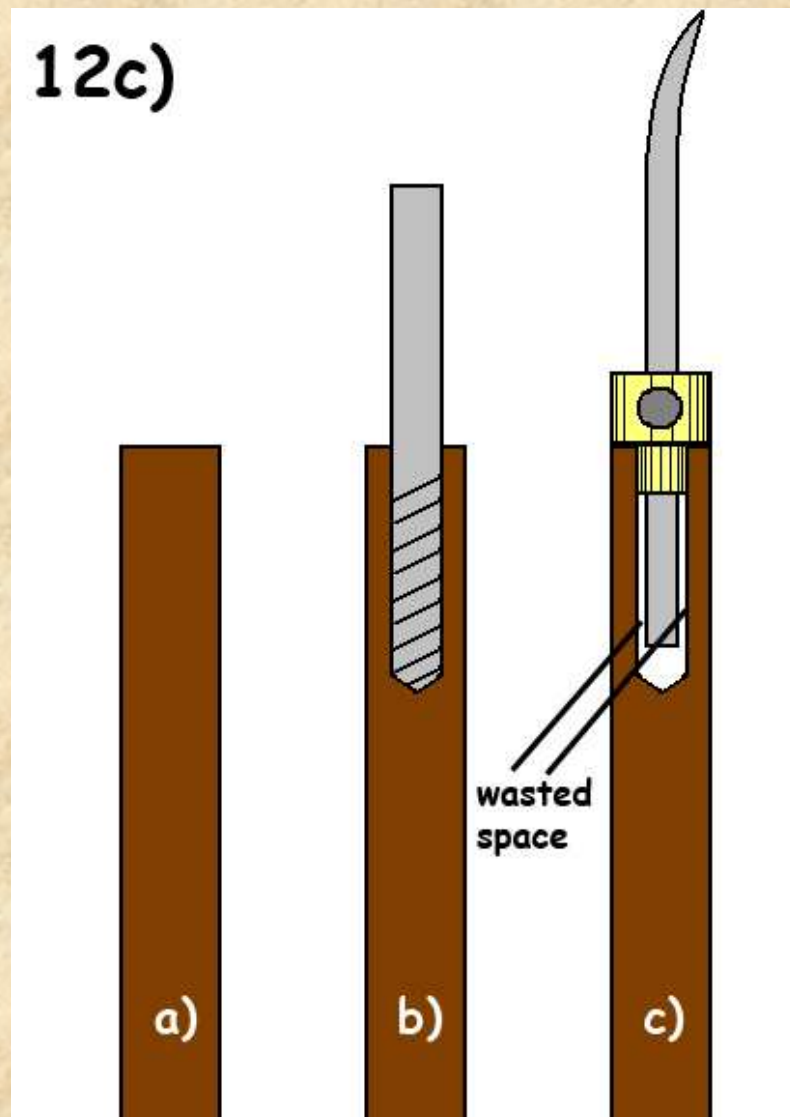

- a) take your wooden handle
- b) drill in a centred 2.0 or 2.5 cm deep hole with a 4 mm drill.
- c) just fix (glue) the adjusting into the hole and fix the tool tip in

Because the hole is now 4mm wide, but the sculpting tools are only 3mm wide, this method leave some "wasted space" (see pic. 12c).

But I don't think, that this is a problem, so personally I make my holes that way.

The **second option** is a bit more work. You can see it on pic. 12d):

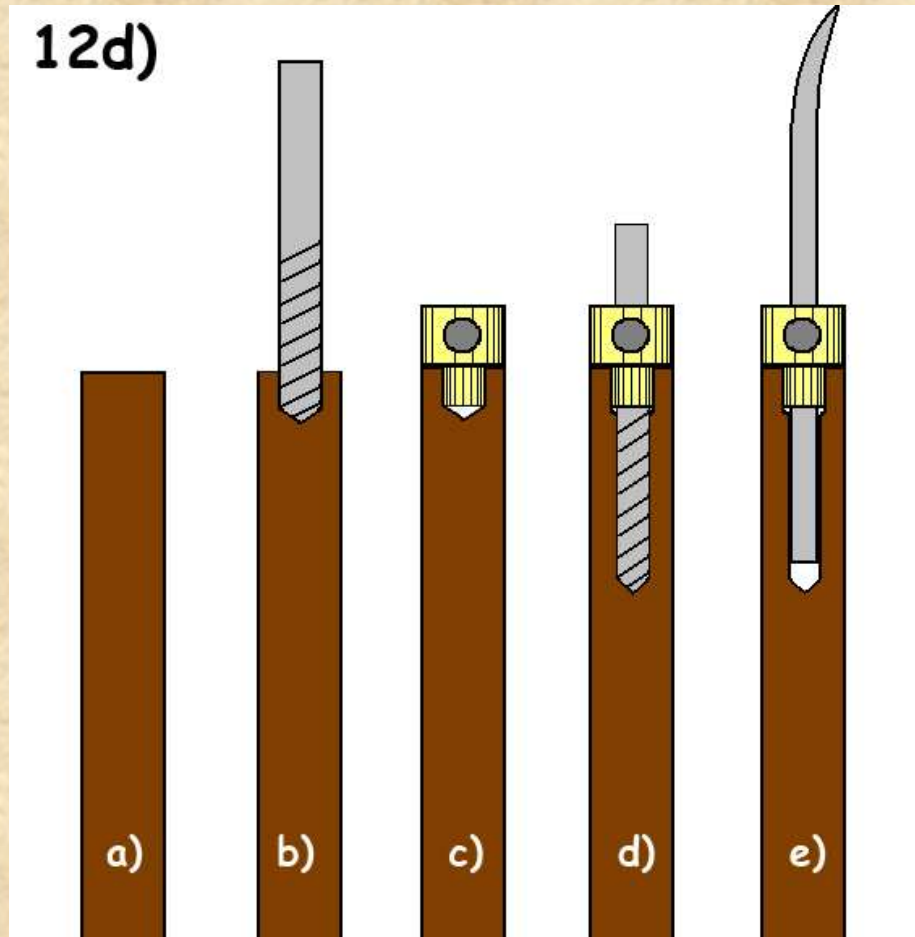

- a) take your wooden handle
- b) drill in a centred hole, with a 4 mm drill, but only 5.0 - 6.0 mm (just as long as the socket of the adjusting ring)
- c) fix (glue) the adjusting ring into the hole
- d) take a 3 mm drill and drill through the hole of the a-ring into the handle
- e) fix the tool tip into the handle

Doing the holes this way makes sure, that the hole inside the handle is only as wide (=3 mm) as needed for taking the tool tips.

It's up to you, which method you would prefer.

If you are in doubt, choose the first option. It's easier to do.

When you got your hole on each side of the handle, just give the handle a good surface with fine abrasive paper and varnish (two layers of varnish are better than one) it as I've explained before.

Be sure, that the varnish is completely hardened before going on to work with the handle.

So just mount your varnished handle on a skewer or toothpick or something like that and place it somewhere to dry without catching dust (pic. 13).

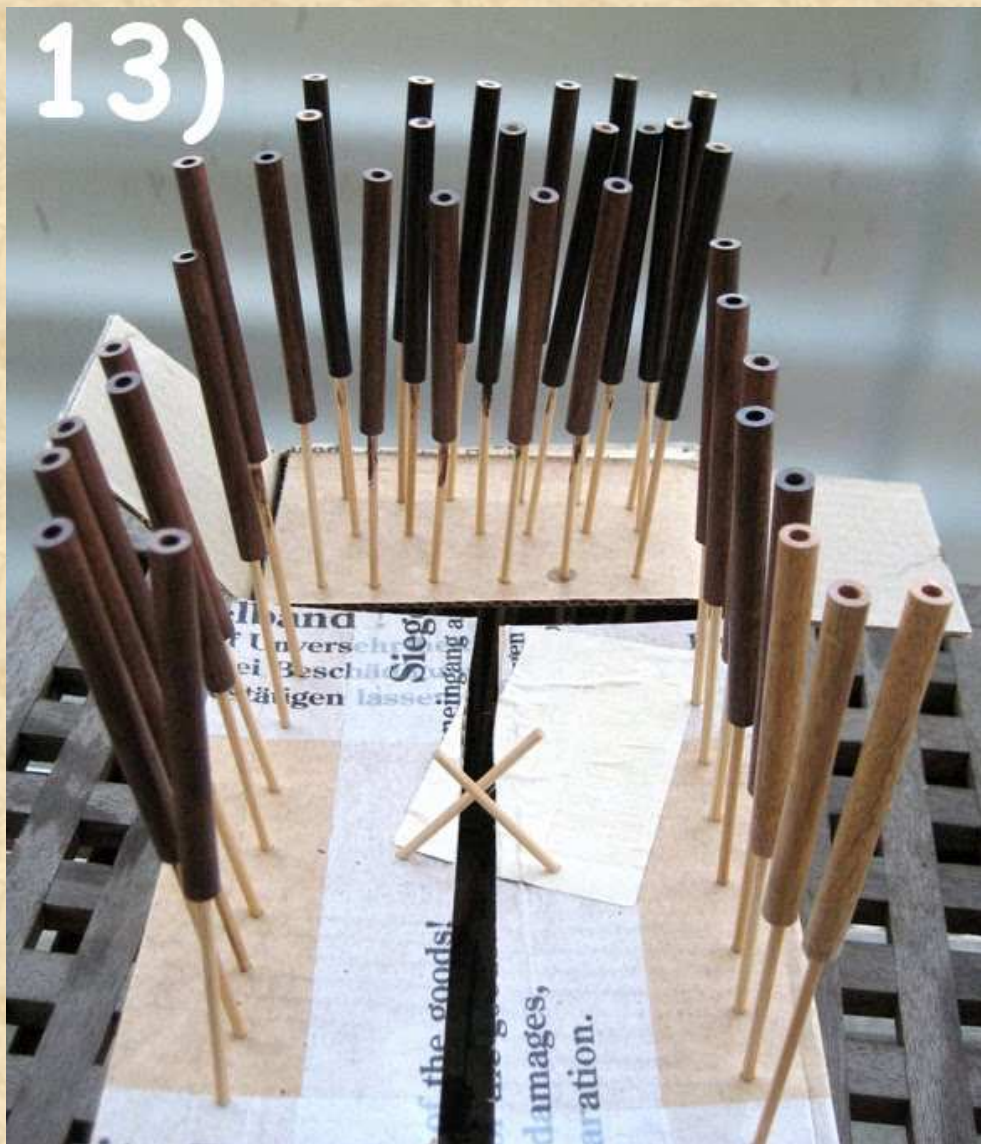



Now it's time to modify the adjusting rings a little bit. The inner diameter of the adjusting ring is 3mm. Of course sometimes it's a little less, so try if you can fit a 3mm tool tip in. If not, just widen the hole carefully with a round needle file (pic. 14).

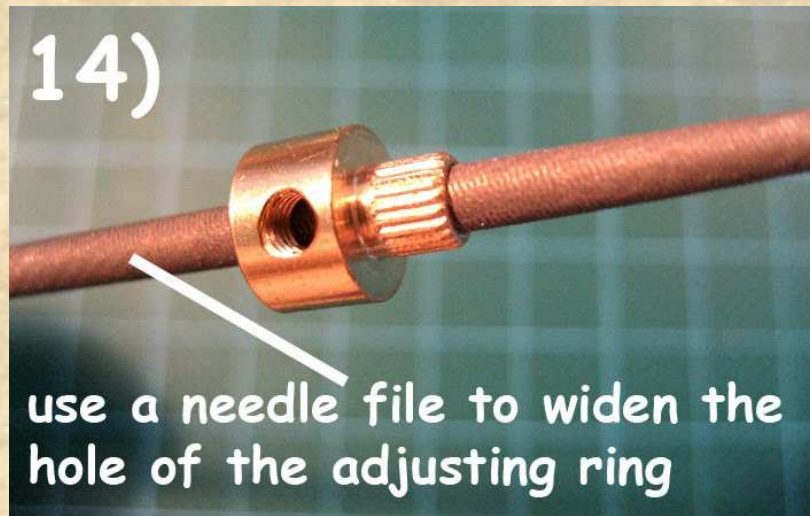

After that just fix the socket of the adjusting ring into the power drill and set it to rotation (not too fast). Then I took a fine belt sander to bevel or round the upper edge of the adjusting ring.

Alternatively to the belt sander you could also use the rotary tool with an insert tool for grinding.

I recommend a rougher grinding stone or even better an insert tool with a cylinder like shaped Grinding paper top.

Be careful not to grind too much. The hole for the headless screw shouldn't be damaged. After getting the right shape just smooth the grinded areas and remove all ugly scratches with abrasive paper and abrasive pads at last, if you got some (pic 15a and 15b).

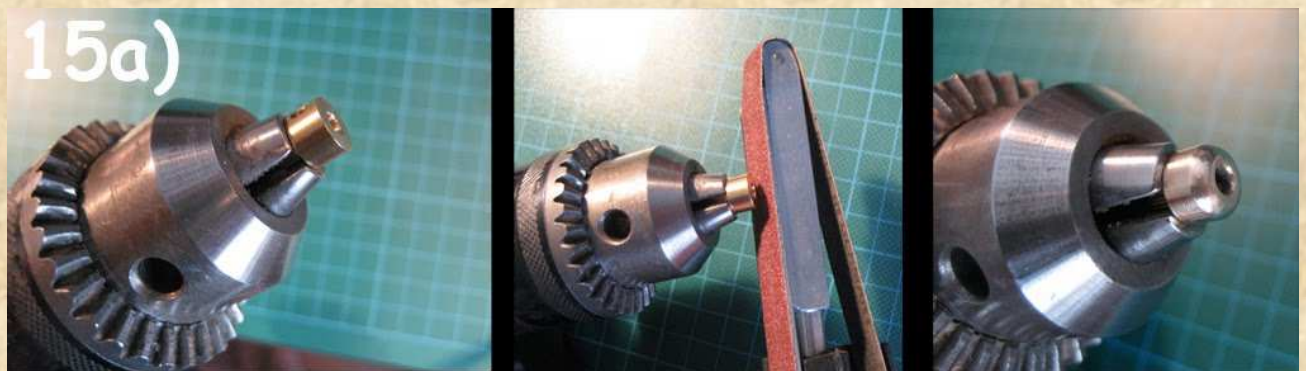

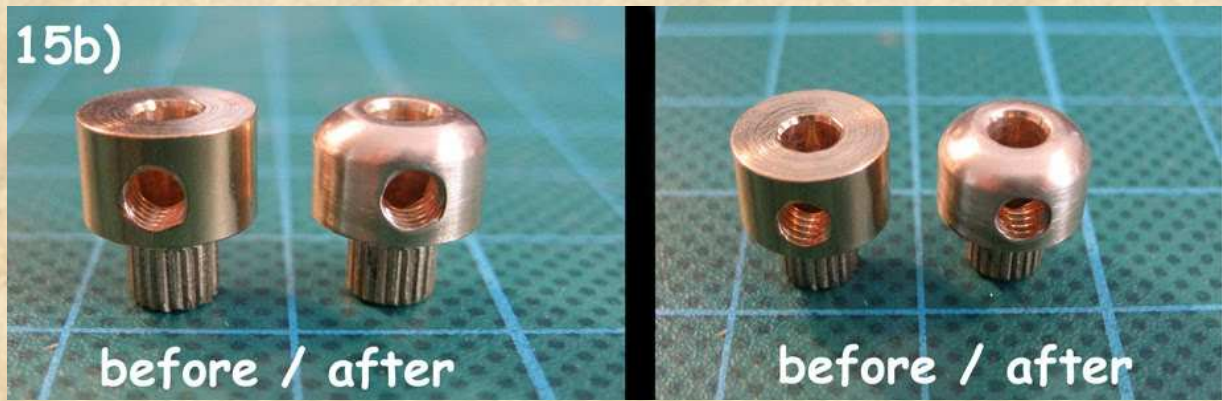

Do the same thing with a second adjustment ring, because you need one for each side of the handle.

All you have to do now is to glue the adjustment rings with their sockets into holes of the handle. Maybe you'll need to tap slightly with a hammer, for getting the sockets into the holes. But be careful here not to hammer too hard.

If it's too hard to get the socket into the hole, this might indicate, that the socket of the adjusting ring is a little too large in diameter. If you would nevertheless go on beating with the hammer, the stress of the socket to the wooden handle could get too hard and the handle might form cracks or break completely.

So take a fine file and file off a little bit from the socket, so it gets a little smaller diameter (don't widen the hole instead, because a larger hole would weaken the handle) (pic. 16). Then try again.

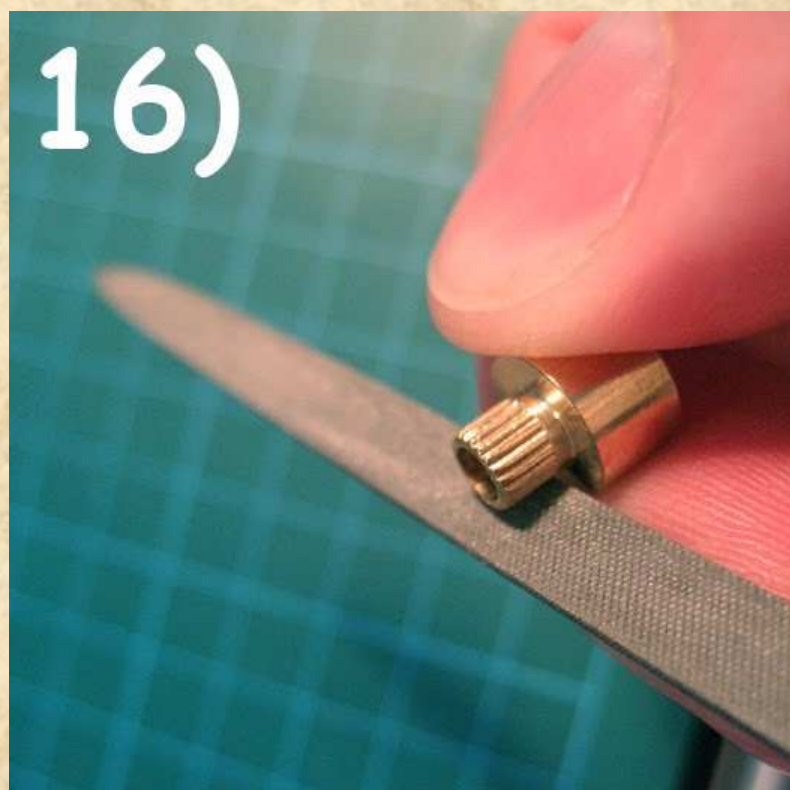

Regarding the glue, you should take one that can fix metal to wood (obviously).

When the glue has hardened, your tool handle is done. As it is now, it will hold 3mm tool tips because the inner diameter of the adjusting ring is 3mm.

You just have to place it in and fix it with the headless screw that comes with the adjusting ring and the hex-wrench (pic. 17).

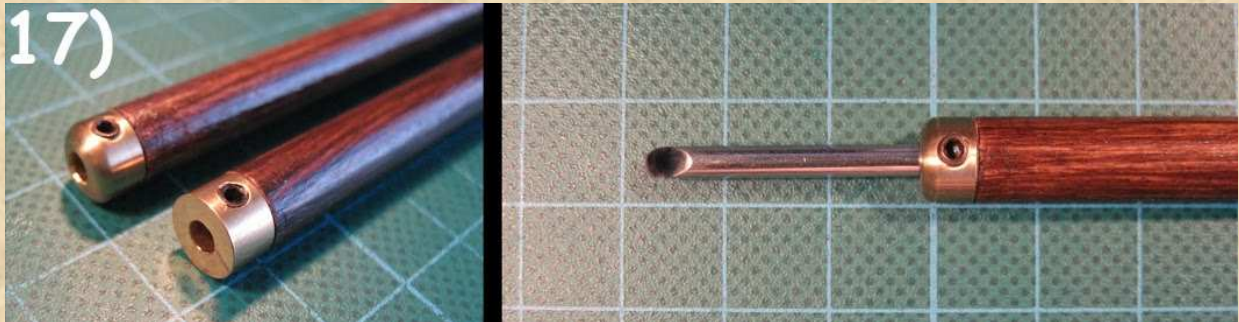

### Reducing Pieces:

As the name indicates, my “standard handle” can be used for all tool tips, regardless the diameter of the steel, they are made of.

Of course the handle, I’ve explained above is primarily made for 3mm-tool-tips.

To fit in tool tips with smaller diameters, I just made “reducing pieces”.

That’s nothing more, than little brass tubes with the right diameters and a hole where the headless screw of the adjusting ring can penetrate it.

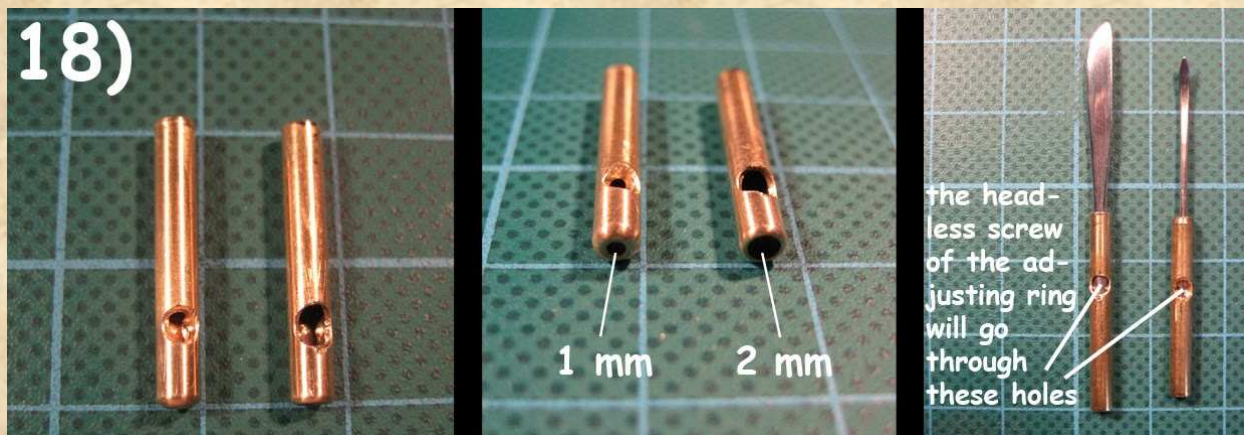

For 2mm (and 1.5-1.6mm) tool tips, I took a brass tube with an outer diameter of 3mm and an inner diameter of 2mm (material strength: 0.5mm).

For 1mm tool tips, I took a brass tube with an outer diameter of 3mm and an inner diameter of 1mm (material strength: 1mm).

I choose the length of these reducing tubes so that they poke out from the handle a few mm, so you can easily grab them, if you want to change the tool tip size (pic. 19).

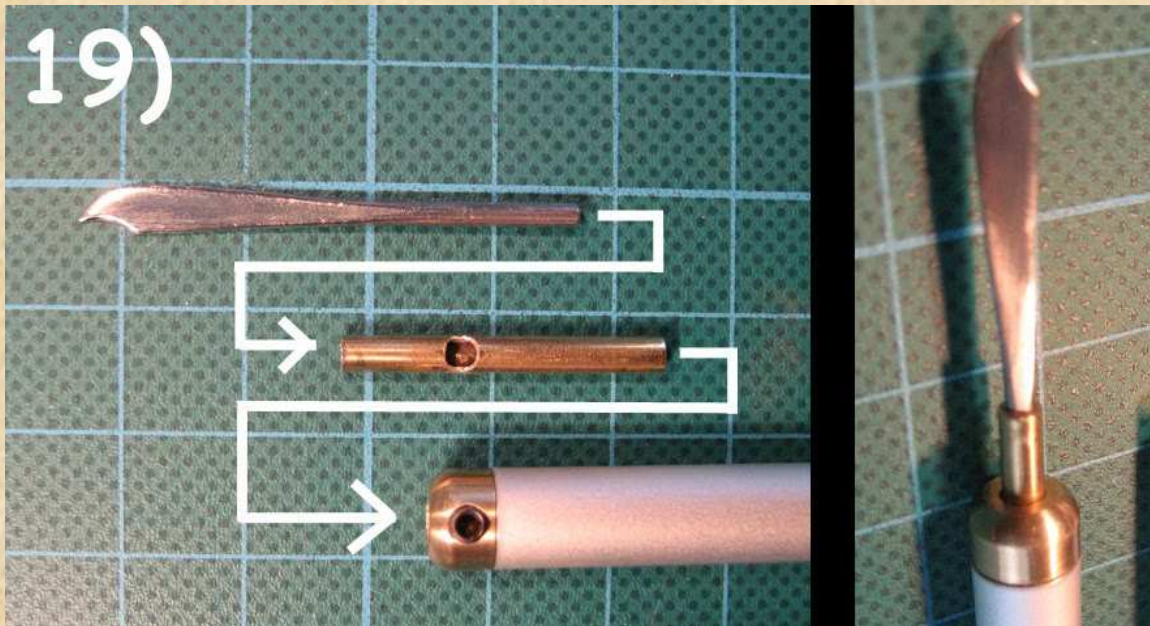

To drill in the hole into the sides of the tubes, just fit them into the handle (adjusting ring).

Remove the headless screw from the adjusting ring and mark the point where the hole has to be with a marker by putting it into the hole of the screw.

If you pull out the brass tube again, you'll see the point, where you have to place the drill. Don't drill through the hole tube, but only to it's half. The diameter should have the size of the diameter of the headless screw or better a little bit larger.

In addition, you should bevel the edges of the drilled hole, so it would be easier for the headless screw to "find" the hole.

Clean the drilled hole from all remaining metal particles, so it won't get stuck into the handle (pic. 20).



Not much more to say about that. Just place the reducing tube with the right diameter into the handle, so that the hole for the handles screw is exactly placed over the hole of the reducing tube, place a tool tip inside the reducing tube and fix it with the headless

screw. The screw will fix the tool tip inside the reducing tube while even fixing the reducing tube inside the handle at the same time (pic 21).



One last hint regarding the reducing piece with an inner diameter of **1 mm**:

Maybe you'll find out that the 1 mm tool tips can't be fixed tight with this reducing piece.

Even you screw it tight it's just not fixed inside the handle. If this should happen, it is because the point of headless screw is too flat for the small diameter of the brass tube.

So replace the old headless screw with one that has an extra pointed tip like you can see on the following picture. You can find these headless screws in hardware stores and building centres, or just on eBay.



## HANDLES - SCHELLERT HANDLE - other versions

### OTHER VERSIONS OF THE SCHELLERT STANDARD TOOL HANDLE

As I told before, you can also use aluminium as the base material instead of wood. So here are some versions of my handle that uses aluminium as material for the handles.

#### Version 1)

Instead of the wood, I just took an aluminium tube with an outer diameter of 8mm and an inner diameter of 4mm (material strength: 2mm). Everything else is the same as described above.

As it is a tube, you don't have to worry about drilling the holes, because they are already there with the right diameter. I admit that it wasn't easy to find aluminium tubes with that size (2mm material strength) and I was only able to find it in the pure, not-anodized quality, so you have to polish the handles (pic. 22).

And one hint regarding the reducing pieces (tubes): If you want to use the reducing tubes with this handle-version, you should keep in mind that the handle is hollowed over the whole length. So you have to avoid to accidentally pushing in the reducing tubes too deep, or they will "drop" into the handle and it would be very hard to get them out again.

Maybe you should think about gluing the reducing tubes permanently into the handle and just use the handle only for tool tips with that size.



#### Version 2)

The second version might be easier for you to build, because this time I used aluminium tubes with sizes that are easier to find. You need aluminium tubes in two different sizes:

The first is an aluminium tube with an outer diameter of 8mm and an inner diameter of 6 mm (material strength: 1 mm).

The second one is an aluminium tube with an outer diameter of 6 mm and an inner diameter of 4 mm (material strength: 1 mm).

As I mentioned before, you have to check, if you are able to place the smaller aluminium tube into the larger one (see the blog entry about the "Schellert-Tool").

As I also said before, it's much easier to find aluminium tubes with those sizes in the hardware store or the building centre and you can find them in the anodized quality as well as in the pure-aluminium-surface quality.

Remember: while using the anodized quality, you don't have to worry about the surface of the handle because it's just fine as it is.

You can build the handle with those tubes in two ways:

The first one is to cut off pieces with a length of 9cm each from each tube (8mm and 6mm) and just glue the tube with the smaller diameter right into the larger one.

It's nearly the same procedure like I've explained for the "Schellert-Tool" with the exception, that this time, the both tubes have the same length. If you have done this, you just have made one aluminium tube with an outer diameter of 8mm and an inner one with 4mm, just like in Version 1) above, so the rest is exactly the same.

The second way is to take two shorter parts of the 6mm tube (say 2cm) instead of using one 9cm long piece. This time, you first glue the sockets of the adjusting rings into these small tubes.

Then you glue this small 6mm tubes with already glued in adjusting rings into each of the hole of the larger aluminium tube.

By doing this, you need less material (less 6mm tube) and that means also less weight (even these handles are quite light weighted anyway) (pic. 23a).

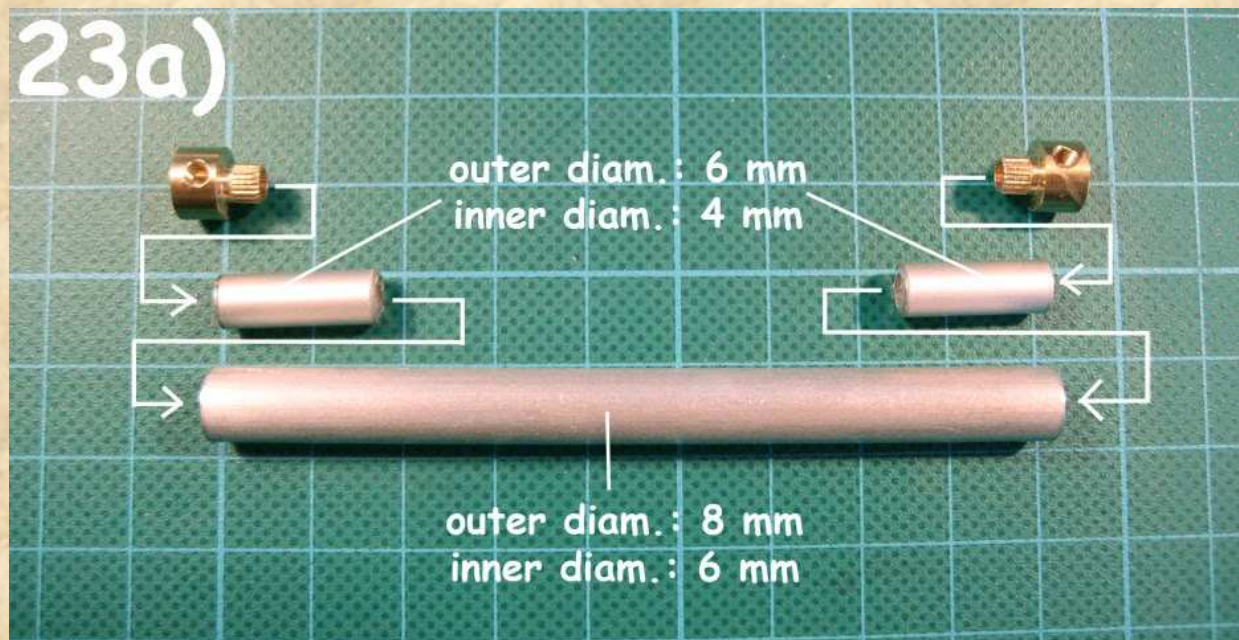

After putting it all together, it looks like that (pic. 23b)

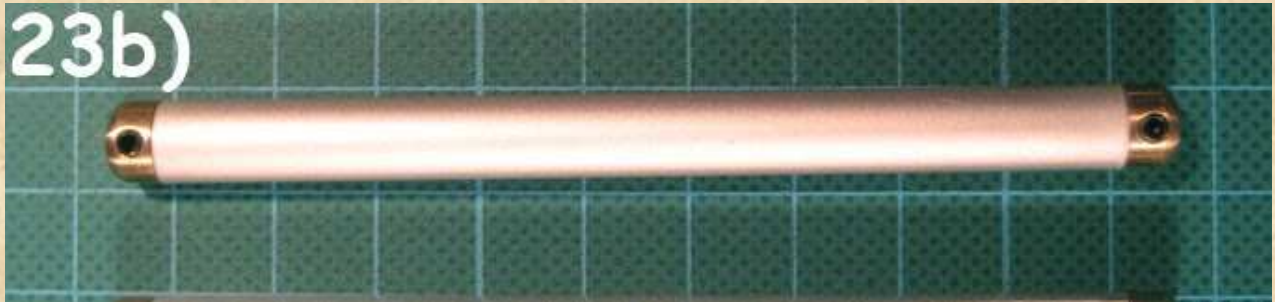

One hint regarding knocking in the sockets of the adjusting ring into the aluminium tubes:

As you use aluminium instead of wood this time, the handle is much less delicate and won't get any cracks even you hit quite hard with the hammer on the adjusting ring to get it into the handle.

But don't let yourself mislead by that to make insensitive use of the hammer now. Even the aluminium might not getting damaged, the brass adjusting ring might.

There are two sensible areas at the adjusting ring.

The first is the inner hole of the ring. If you beat the ring too hard or too often, the brass starts to deform and you might discover, that the diameter of the hole is getting smaller.

It's possible that a 3mm tool tip that fits perfectly at the start wouldn't fit anymore if you made too much use of the hammer.

If this should happen, you have to widen the hole with a file again (See the chapter about the SCHELLERT standard handle).

The second is quite more critical. It's the threaded hole for the headless screw. If you damage this so the screw can't work anymore, your tool holder is a case for the garbage can.

So I recommend leaving the headless screw inside the adjustment ring while using the hammer. This reduces the risk of the hole getting deformed accidentally by the hammer blows.

And of course it's better to grind of the socket of the adjustment ring a little bit (see what I've said about the standard tool tip holder above) than to hit harder with the hammer.



### Version 3)

The last version of my handle is simply a smaller one.

Instead of using an aluminium tube with an outer diameter of 8mm, I just use one with 6mm.

For that I use a smaller version of the special adjusting ring that I described above.

There's one available with an outer diameter of 6mm and an inner diameter of 2mm. The outer diameter of the socket is 3mm on that adjusting ring.

On the next picture, you can see the comparison of the small and the large adjusting ring (pic. 24).

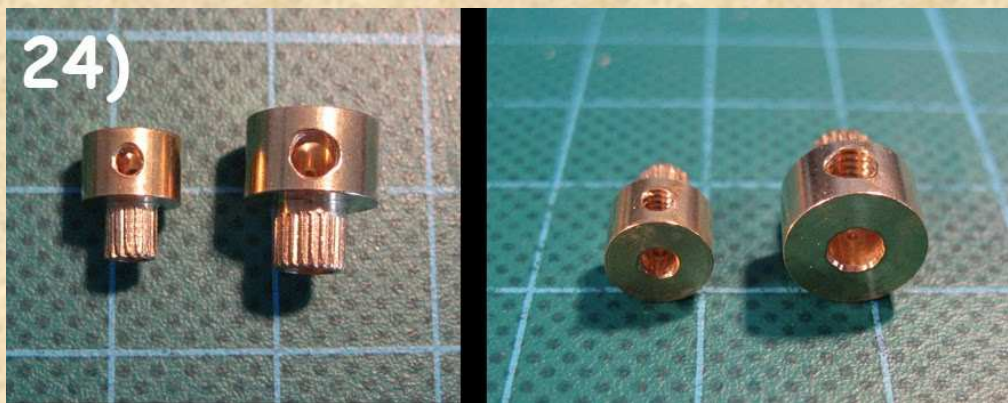

As the inner diameter of the 6mm aluminium tube is 4mm, you have to use short pieces of a brass tube (with outer diameter: 4mm / inner diameter: 3mm / material strength: 0.5 mm) in a similar way as I described for version 2) above.

So glue in the ring's socket into the small brass tube. Then glue the brass tube with the ring into the 6mm aluminium tube.

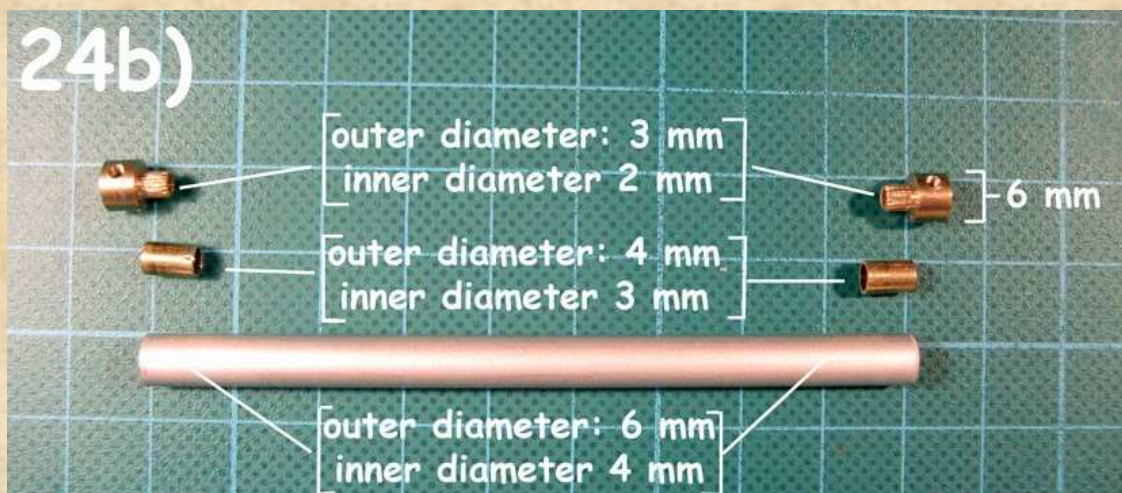

If you like, you can also bevel/round the upper edge of the adjusting rings like I explained for the larger version of those adjusting rings (see chapter about the SCHELLERT standard handle).

This handle is made for 2 mm tool tips (1,5 mm tool tips would also fit in). On the next

picture you can see the comparison of the small handle and the large (=normal sized) handle with a reducing piece (2 mm). Both hold 2 mm sculpting tool tips (pic. 25).



On the following Picture you can finally see all versions of the Schellert handle. The handle made of beech wood is covered with palisander(rosewood)-varnish (therefore the dark brown colour) while the other wooden handles are covered with clear varnish. So the pure metal-handles are best for sculpting science fiction miniatures, while the brown handles with the brass parts are best for sculpting steampunk miniatures (joke alert).



So, that's nearly all about the handles, I've developed for holding the tool tips.

The critical point so far is this special adjusting ring, that all handles are built with. So maybe you'll have some problems to find such a special adjusting ring with integrated socket.

But even that would not be a problem. Instead of those special rings, you can use just ordinary adjusting rings and a little brass tube to make a very fine alternative.

In the next chapter I'll tell you exactly how to do this.



## HANDLES - alternative to the special adjusting ring

### ALTERNATIVE TO THE SPECIAL ADJUSTING RING WITH THE SOCKET

As I promised before, here's a way to build the tool handle without these special adjusting ring with socket that was used for all handle versions so far.

This alternative might be useful because maybe you'll have problems to find these special adjusting rings with sockets. In fact, I found only one retailer who sells this kind of adjusting rings.

The idea behind this alternative is to combine an ordinary adjusting ring (without this special socket) and a small brass tube by gluing both into the wooden handle like you see on pic. 27).

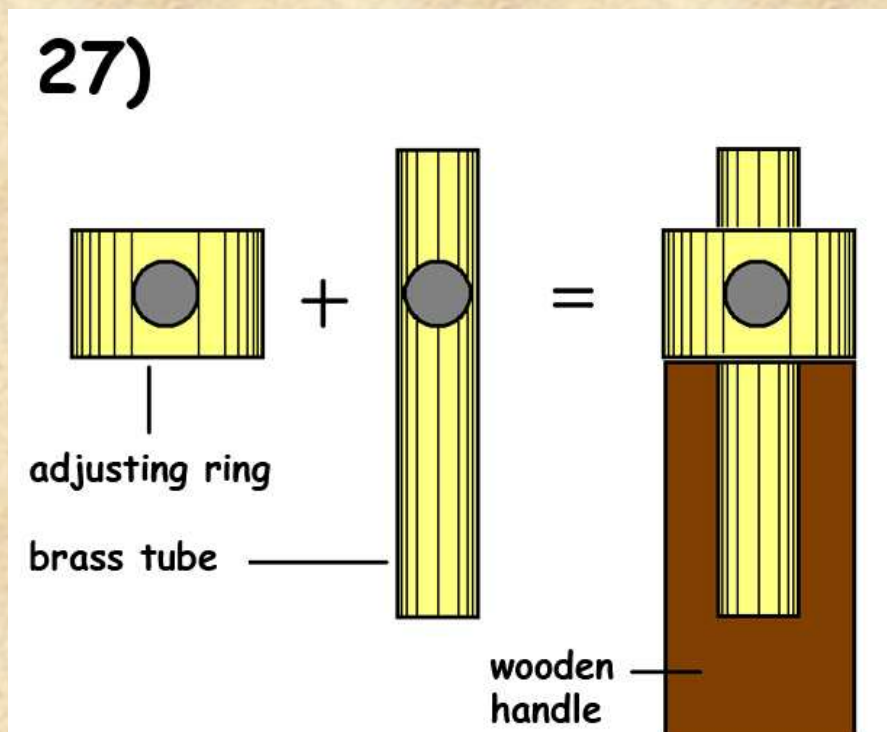

For doing that you have to find ordinary adjusting rings with the right size. As I prefer sculpting handles with a diameter of 8 mm, the adjusting rings should also have an outer diameter of 8mm. The inner diameter depends on the size of the sculpting tool tips, you want to fix in the handle later.

Basically, there are two sizes for the inner diameter that make most sense: 4 mm and 3mm.

If you want to round (bevel) the adjusting rings, like I explained before, I recommend using adjusting rings made of brass or aluminium.

Other materials especially steel might be too hard to grind it down. I use adjusting rings made of aluminium as you can see on the pictures.

An adjusting ring with an inner diameter of 4 mm can be combined with a little brass tube with an outer diameter of 4 mm and an inner diameter of 3 mm (material strength = 0.5 mm) to hold 3 mm tool tips.

An adjusting ring with an inner diameter of 3 mm can be combined with a little brass tube with an outer diameter of...

- 3mm and an inner diam. of 2mm (mat. strength = 0.5 mm) for 2 mm tool tips or
- 3mm and an inner diam. of 1mm (mat. strength = 1.0mm) for 1mm tool tips.

Remember if you this 1mm brass tube: It might be better to use this special pointed headless screw for the adjusting ring like I've explained for the "reducing pieces" before (see "the SCHELLERT handle").

You have to drill in a hole into the side of the little brass tubes where the headless screw of the adjusting ring can go through. That's quite similar to what I've explained about the "reducing tubes" above.

To find the right position for the hole, just put the brass tube inside the adjusting ring and mark the right point with a marker, like I've explained before for the "reducing pieces".

Then just drill the hole with the right diameter into the brass tube. The hole has to be as wide as needed to allow the headless screw to pass it.



You can round (bevel) the upper edge of the adjusting ring just like I've explained before for the "special adjusting rings with socket (on pic. 28) above, the ring has already been rounded).

For doing that, just screw the adjusting ring on a spare piece of brass tube with exactly the same diameter as the inner diameter of the adjusting ring. The brass tube shouldn't poke out of the adjusting ring.

Then fix the brass tube with the ring into the power drill. Set the power drill to rotation and grind down the upper edge of the adjusting ring with a small belt sander or a rotary tool with an abrasive wheel.

You can see the different stages in the following pic. 29).

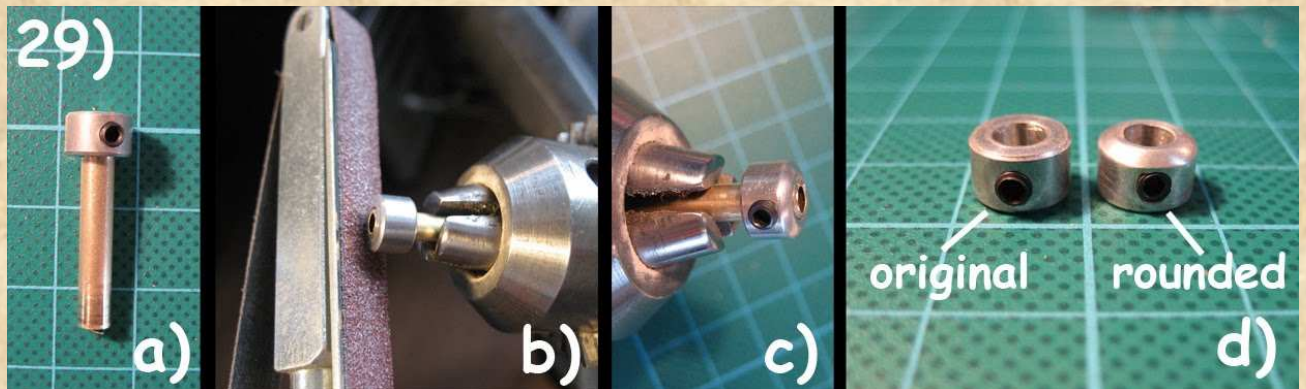

If you've done this, just glue the brass tube into the hole of the adjusting ring so the headless screw can go through the hole in the brass tubes side.

Then you can use this new part in the same way, as I've explained above for those special adjusting rings with sockets.

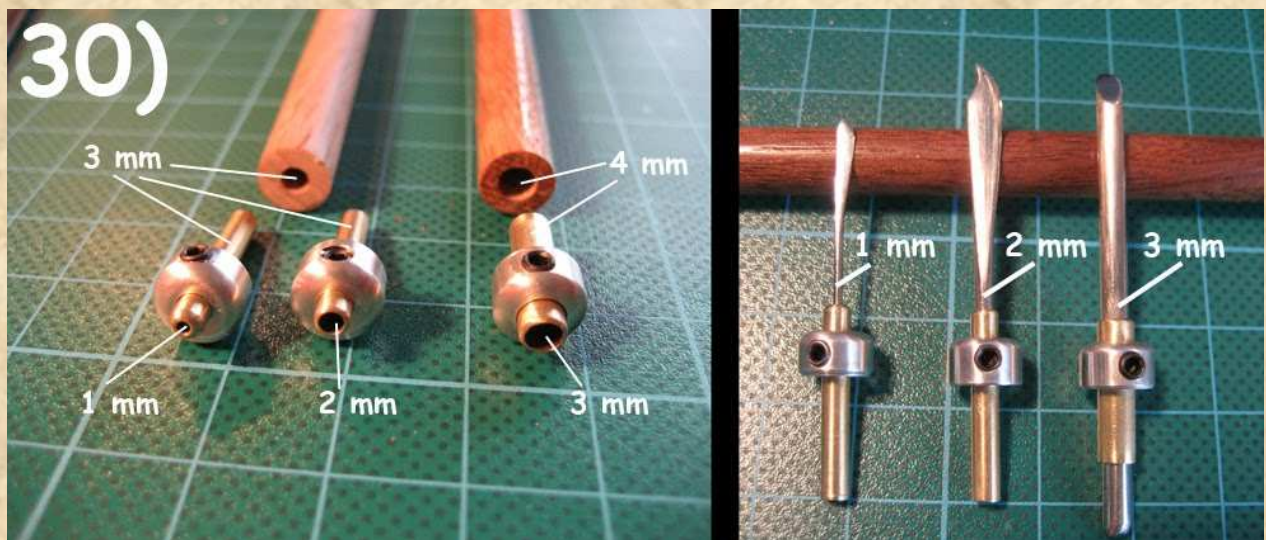

So just glue this part into the hole in the handle as I've explained above. As before, you can use handles made of wood or aluminium.

Be sure, that all parts that touch each other are covered with glue. But be sure, that the glue didn't plug the threatened hole for the headless screw.

After pressing all parts together, remove spare glue (it should not stain the handle) and let the glue getting completely hard.

On the next picture you can see Handles in all 3 sizes (1 mm, 2 mm, 3 mm) that are made with the alternative version of the adjusting ring.

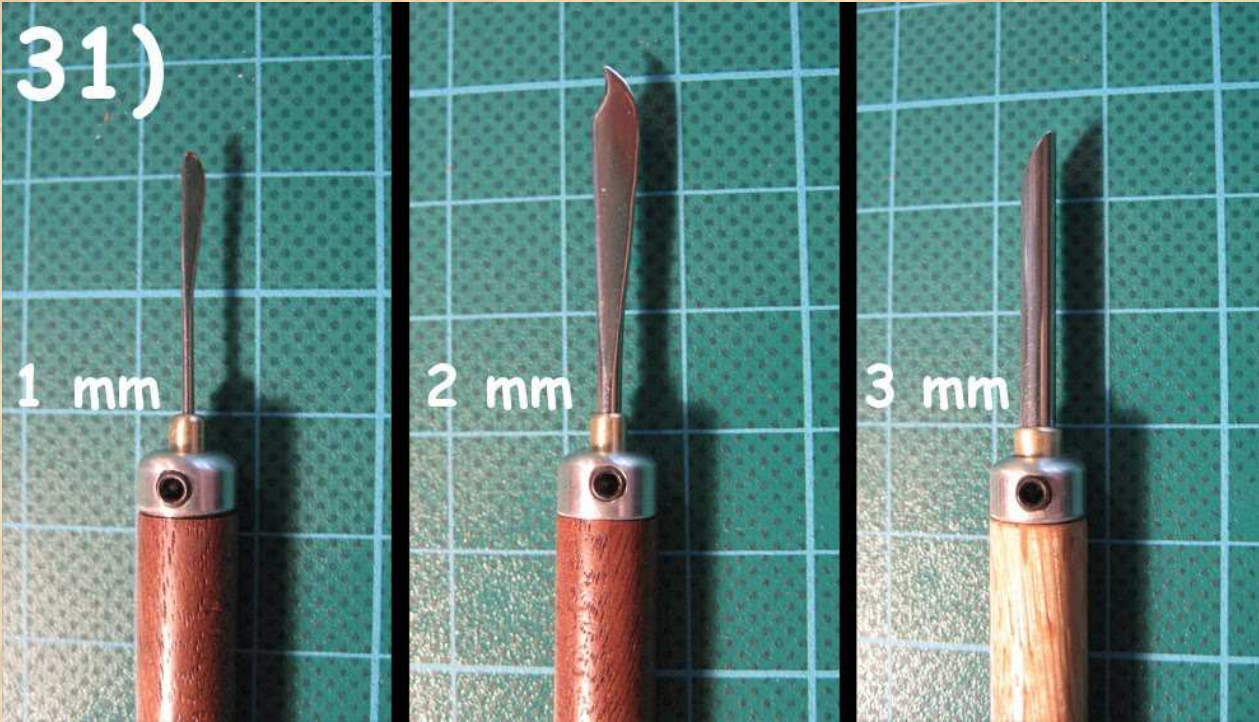

That's it.

## (NEW) HEXAGONAL ALUMINUM HANDLES

There's another little idea about tool-handles, I came across lately. In a hardware store I found hexagonal alliper rods in the size of a classical wooden pencil and I thought, these would make some nice tool handles. The wrench size of these rods is 7.0 mm. So I cut off pieces with a length of 10-11 cm from these alliper rods like you can see on the following picture.

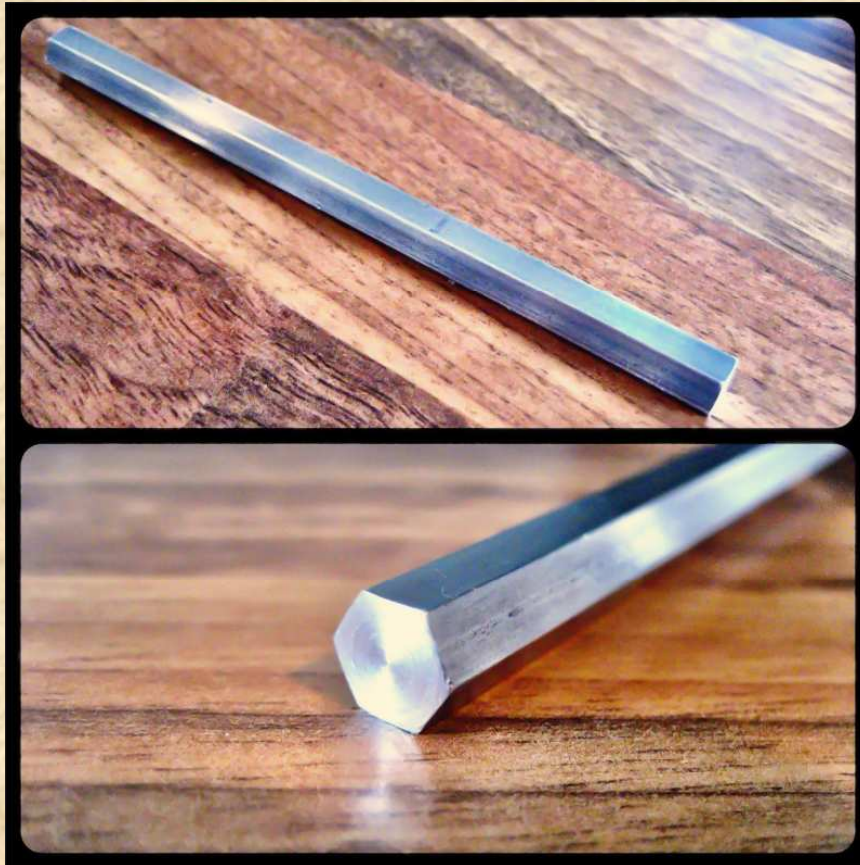

Then I drilled an axial hole on each side. In fact I made three versions with holes in 1.0 mm, 2.0 mm and 3.0 mm size for holding 1mm, 2mm and 3mm tool tips like you can see on the following picture. I confess it is not easy to get the holes exactly centered. After that I drilled in small holes with a diameter of 2.5 mm in at a 90 degree angle to the first hole and about 0.5 cm from the end of the rod. In this holes I cut threads with a m3 size, so headless set screws with m3 size will fit in.

These set screws will fix the tool tips inside the handle. Of course you don't need the whole side-holes-and-set-screw thing. Instead of that you just can glue the tool tip inside the axial holes with metal glue, but I prefer the set screw solution because it gives me the option to change the tool tips and to adjust the length of the tool tips.

Finally I bevel the ends of the tool handles because I don't like these hard edges on my tools, but this is more an aesthetical aspect then a technical need. I do this by fixing the rod into an electric drill set it into rotation and carefully grind it down with an electric file or a usual metal file.

Finally the whole thing looks like that:





What you can do at last is to give the handles a nice and smooth surface by using fine grinding paper and a polishing wheel (on the picture the handles are not polished).

Ah, I nearly forgot to point out a main advantage of this tool beside the fact that it feels like a pencil. It didn't accidentally roll from your desk because of the hexagonal shape and this is a big point, especially if you use small and delicate tools that could easily be damaged.

So I hope you like this idea.

## THE MICRO CALIPER

### THE MICRO CALIPER

About the next thing that I want to show you, I'm not sure, if it's really a useful tool, or more a kind of tool-fetishism. So it's up to you to decide if it's the one or the other.

The use of calliper is quite common in life size sculpting. It is used as a sculpting aid to check proportions and to transfer sizes onto the sculpting. On the following photo you can see such typical sculpting calliper (pic. 1).



I thought, even though we do quite small sculpts, such a tool might be also useful for us miniature sculptors, so I made this miniature-version of a calliper. You can see this calliper on the next photo (pic. 2).



With this, you can check the proportions of your sculpture (for example: have both arms the same length? Is the left biceps thicker than the right one?) or you can transfer the correct length from a ruler to the sculpt or in reverse, check the exact size of a sculpt-part by putting it between the calliper "claws" and then checking the length on a ruler (pic. 3).

3)



It's not difficult to build such a calliper. In short words, you just need to cut out the two "claws" of the calliper from a sheet of metal and to fix them with a bolt and nut. And that's how it goes:

**Material:**

You need a sheet of brass with a material strength of 1mm. A piece 10cmx10cm would be enough. There are different qualities of such brass sheets out there. You should take the "hard" quality so your calliper won't bend too easily. Theoretically you could use other metal for that, but 1mm aluminium would be too soft and therefore would bent too easily and steel would be really hard to cut, so I recommend the brass. This kind of brass can be found in hardware stores or building centres or in model craft and hobby stores.

Then you need a bolt and a nut with m3 size of. Be sure to choose a bolt with a flat head, otherwise it might stand in the way when you hold the calliper later. You also need a special nut, a self-locking nut. This kind of nuts has some sort of plastic inside that prevents the nut and bold to accidentally unscrewing. The thread of the bolt would stick into this plastic. This kind of nut is important for your calliper to work properly. These nuts can be found in every hardware store or building centre.

If you are not from Germany (and I guess, most of you are not) you don't have to search for those nuts and bolts with metrical system. Just get those small nuts and bolts that you can find. The correct size isn't that important here. You can also use bolts (screws) from the computer store (see below). You just have to be sure, that the hole that must be drilled in the calliper claws have the same size as the bolt you use.

Another thing you'll need to get your calliper work properly is a special kind of washer. It will be placed between the two "claws" of the calliper and prevent the two "claws" from scratching on each other and that guarantees a smooth movement of the calliper "claws". So the washer you should use has to be very thin and not to be made from metal (scratching!).

So I found that the washer that works best are one of those that comes in connection with the screws (Bolts) for the computer cases and components. These red or orange washers are made of some kind of plastic and they are very thin (see pic. 4).

Beside that you'll also need two ordinary washers made of metal that are made for m3 screws (see pic. 4).

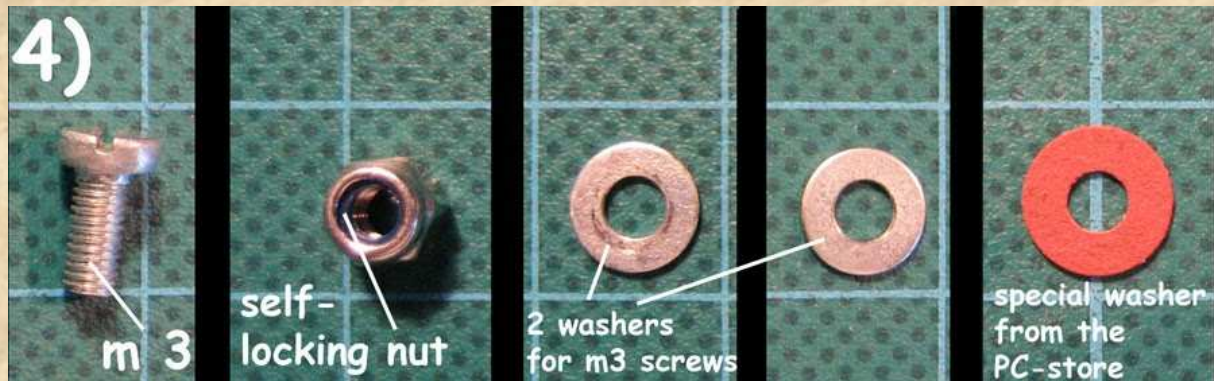

**Needed tools:**

As tools you'll need a jigsaw with fine saw blades made for cutting metal (pic. 5)



**Power drill:**

You'll also need an electrical drilling machine (power drill) and a 3 mm metal drill. Also a small metal file and fine grinding paper will be needed.

**PC and printer:**

Then you need a computer (we're getting high-tech now) and a printer that is able to print on sticker-foil-paper (nearly all printer can do that) and of course a sheet of transparent sticker-foil-printer paper. I mean these transparent foils on paper that are made to be printed with a pc-printer. Than you can peel the paper off and the remaining printed foil has a sticky side, so you can stick it on any surface you like. The official English term for that paper is "transparency film, self adhesive". At least that's what is printed on the box. You'll get this kind of "printing-paper" in every shop, were you can buy the ordinary printing paper for pc's.

### **How to build the calliper:**

The base idea is to construct the right shape for the calliper-claw in your pc then to print it out as a template with your printer on sticking-foil, stick the foil onto your brass sheet and cut out the brass around the shapes you see now on the brass with the sticker.

If you want to construct your own calliper shape, I recommend using the software called INKSCAPE. It is freeware and a very good vector-graphics-program for this kind of work.

You can find it here: <http://www.inkscape.org/>

But maybe not all of you have the nerve to draw their own calliper shape, so if you like, you can use the shape I've made for my calliper and that you see on the next picture.



I made my calliper with two pairs of claws (one longer side and some shorter one). I found, this will give it more variations to use it and –as a side effect- you can hold it in your hand much easier.

So first you have to print out the calliper shape on printable sticky foil paper. To avoid problems with the printer settings, be sure that the printed shape has a size of 4.87 x 3.41 cm (that's the size of the original template. Of course you can change the size if you like).

Do a test printing on ordinary paper and check if the size is correct before printing on the printable-foil-paper (pic. 8). Remember: You need two of these calliper-claws to make one complete calliper, so you have to print two of these shapes on your foil-paper.

After printing out the shapes correctly, just cut out the printed part of your foil-printing-paper roughly, peel off the paper and stick the remaining “sticker” to a corner of your brass sheet (see pic 8a-e).

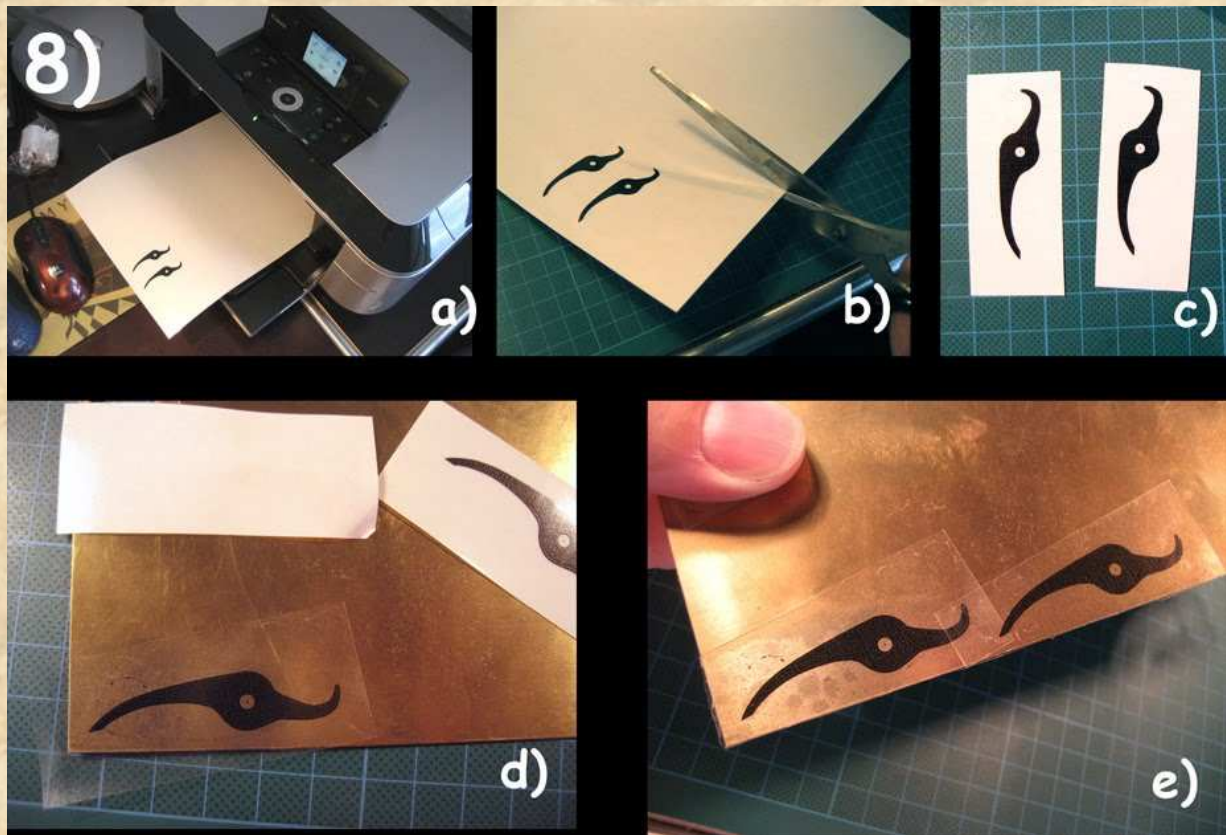

Then, before cutting out the shapes with the saw, just drill in the holes in the middle part of the calliper “claws”. For that, you’ll find in the middle of the little circle a tiny black spot that shows where the hole has to be (pic 9). This spot marks the centre point where you have to place the drill.

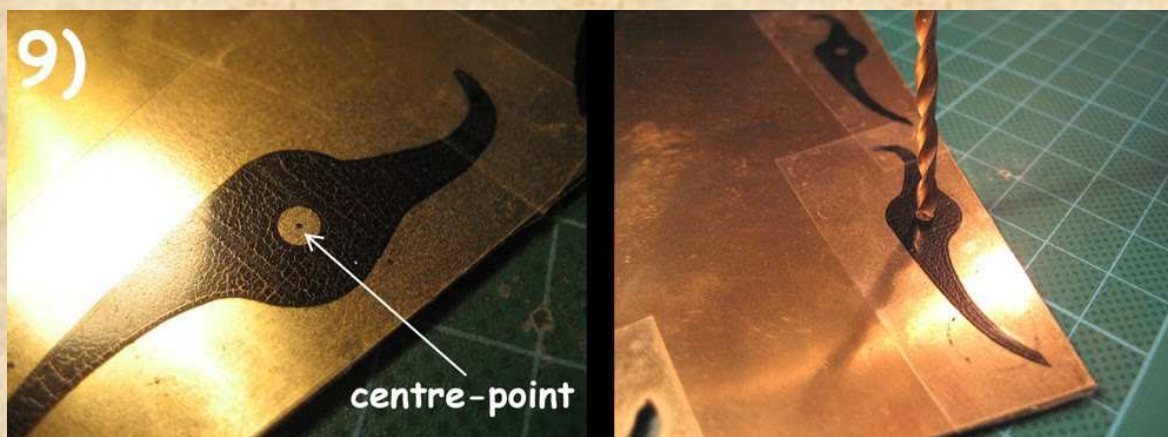

The reason for me to recommend drilling before cutting out the rest is that the “cutting out” is quite a bit of work. So if you would do the cutting first and the later drilling went wrong, all the cutting-work with the saw will be lost. So I guess it’s better to start with the holes.

Now after drilling the holes, you can start cutting out the shapes with the saw. You might find that the cutting will go on boring slow, but just be patient. Ah, and if your saw blade break at some point, don't worry, that is quite normal. Just take another saw blade and go on.

After cutting out the two shapes, just refine the edges with a file and grinding paper and round them up except for the small edge at the top, where the two calliper claws meet. This edge should be left "sharp".



Now, all that's left to do is to screw all the parts together. In the middle is the red plastic washer, than comes a calliper-claw on each side, followed by a ordinary metal washers on each side and then the nut from the one and the bolt from the other side (pic. 11).

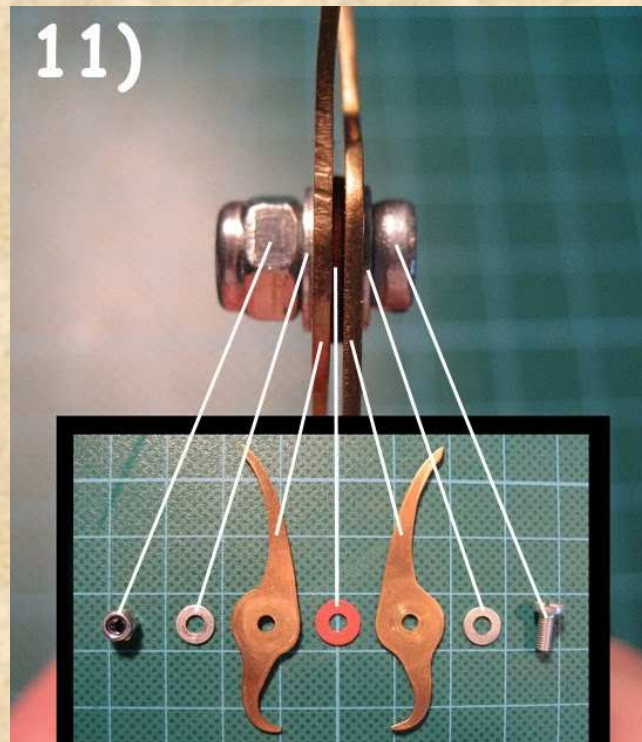

Because the ends of the two calliper claws are not exactly at the same level, you have to bent the two "claws" slightly to each other, until the points exactly meet at the same level (see pic. 12).

12)

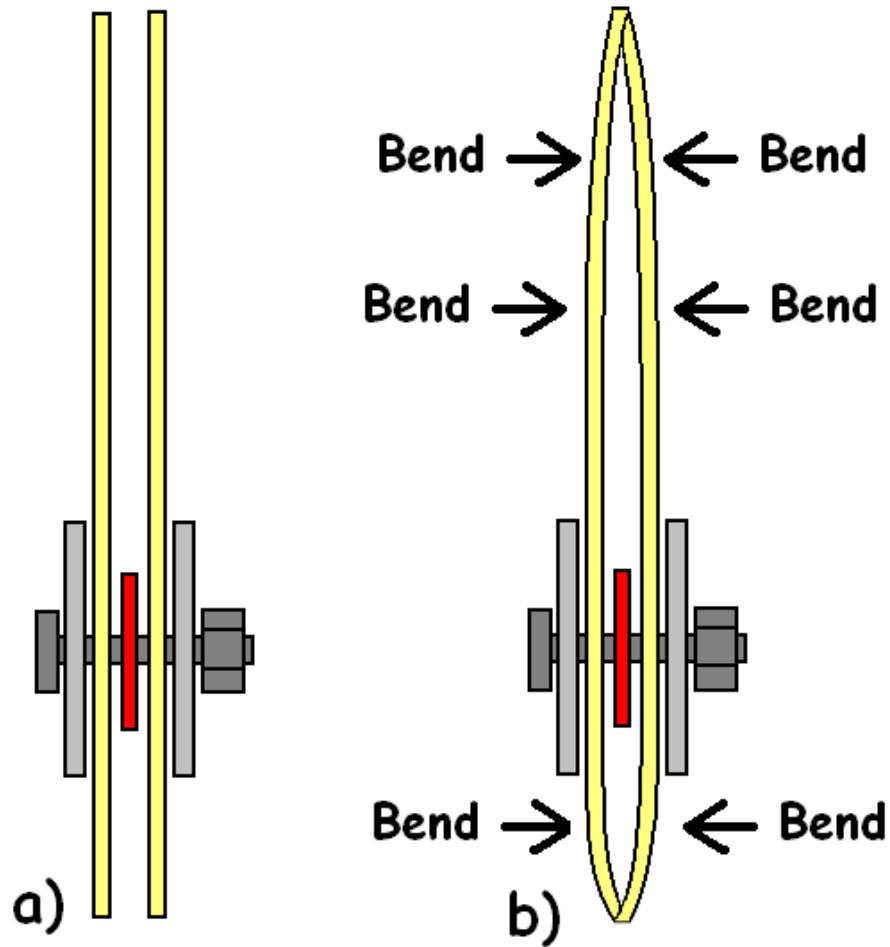

12b)



both claws bent, so they meet at the same point

Screw the nut and bolt as tight that there is some resistance while opening and closing the calliper claws while they can still be moved smoothly.

That's it. Your calliper is ready to be used. I hope you'll like it. As I told you before I'm not so sure about its real worth for getting better sculpts, but at least this little brass thing looks really cool, no?



## THE SCHELLERT ARMATURE

Today I want to talk a little bit about armatures for sculpting miniatures.

I guess most of you are familiar with the basic aspects of sculpting miniatures. So you surely know that you'll need a solid foundation for putting your putty on if you want to sculpt a humanoid miniature (and not only a "blob").

There are two alternatives for such a foundation. 1. You can take a so called dolly. That's a skeleton-like substructure cast from white metal. There are several different versions of these dollies available from different manufacturers (for example: Reaper, Ebob, or Hasslefree Miniatures to name a few). The advantage of the dollies is that you don't have to worry about proportions, because you can use them just like they are. The disadvantage is, that because of the material, they are made of, they break quite easily when you try to bend them to get the limbs into the pose you want to have. Because of that, some (more extreme) poses can't be sculpted with these dollies. Another disadvantage comes from the preset proportions, because only small variants are possible.

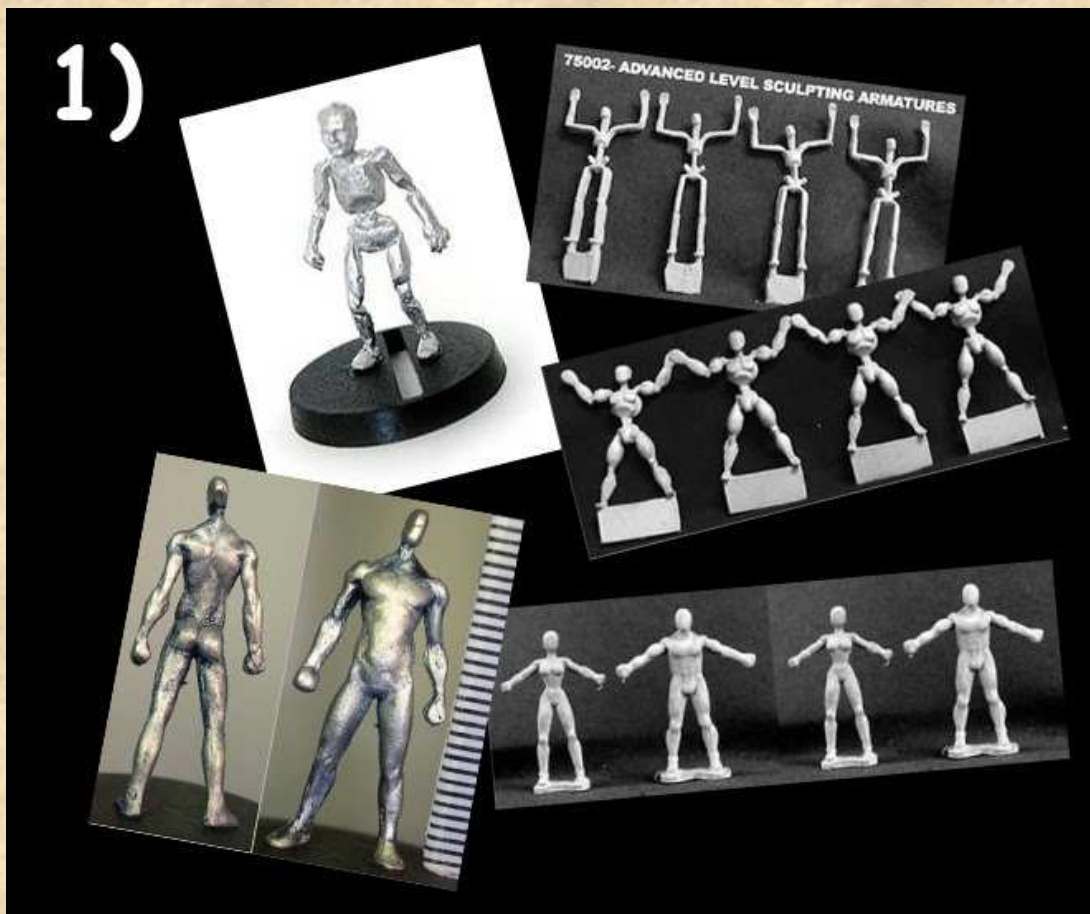

2. The second way to build a foundation for your sculpt is to make an wire armature from scratch. Usually two pieces of wire are twisted together so the twisted part forms the torso, while the wire ends are bent to form arms and legs (pic. 2).

The advantage of these wire armatures are, that you can do every pose you like. The wire can be bended easily into the needed position without breaking. You also can do every variant of size and proportions because you do it all from scratch and so there's no restriction to pre-cast proportions. In reverse, the disadvantage is that you have to find the right proportion again every time you do a new armature. Another disadvantage is that it is difficult to get a "5 point armature" (1 head, 2 arms, 2 legs) from twisting two pieces of wire together. Usually you can choose between a "3 point armature" (head, spine and legs) or a "4 point armature" (two arms, spine and two legs). In both case you have to add an armature/wire for the arms (3-point armature) / the head later (4-point armature).

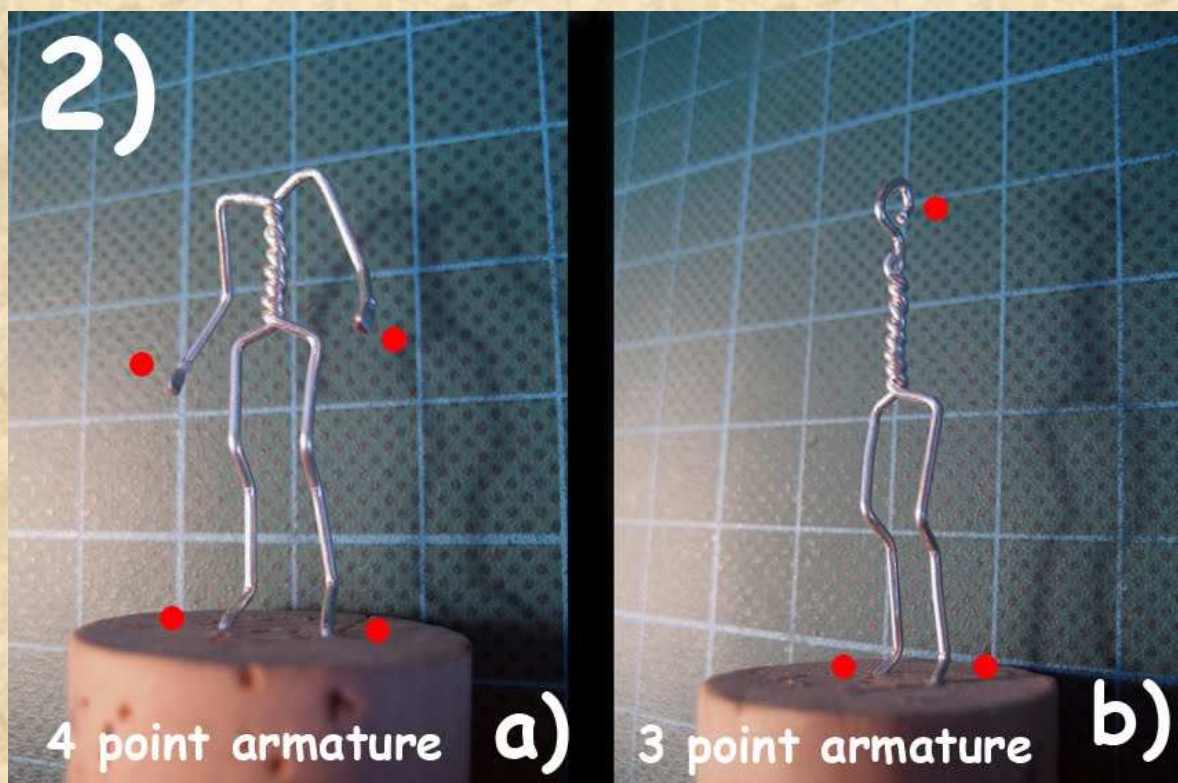

So both, dolly and armature have their advantages and disadvantages and I thought about a way to combine the advantages of both, while eliminating the disadvantages.

So I came to the idea to cast my own "dolly" with cast-in wire parts for the arms and legs. The advantage of this hybrid-armature is that you got a "5 point armature" with some proportions, but also with legs and arms, that could be bent without breaking.

I developed two versions of this kind of armature (I call it "Schellert-armature" because of my last name). The first version has a complete torso including hips while the other ones torso exists only of head, neck and ribcage.

The first has more given proportions while the other one allows more adjustments regarding the height. On pic. 3 you can see the two versions and their use.

3)

### X-TYPE-

Armature

Made of white metal with cast in wire

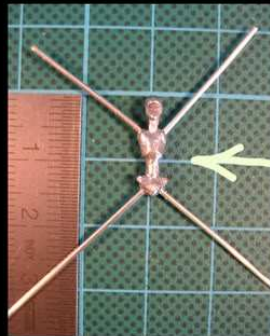

Version one



### Y-TYPE-

Armature

Made of white metal with cast in wire

spine, hips, arms and legs are adjustable, so it can be used from „Dwarf“ to „Orc“-size



1



2

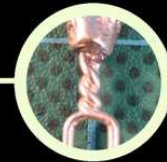

I admit that it's a bit of work until you get such a hybrid armature because you have to do a "master", build a drop-casting mould from it and then cast the armature.

Maybe it's too much work if you just sculpt a few miniatures. But once you've got the mould, you can cast as much armatures as you like quite fast. So if you need some more armatures for your work, maybe it's worth to invest the time.

So this is how you can make your own "Schellert-armature":

I assume that you are familiar with the process of making drop cast moulds from heat resistant rtv-silicone rubber, because I won't describe that. If not, there are lots of tutorials that can be found on the internet.

It's really not as complicated as it might look on first view.

First of all you need an “original” of the armature. Instead of wasting many words about how this has to be made, I just show you in pic. 4) how my master-armatures look like.



To fix the wire parts, I just drill in small holes into the sculpted part and glued the wire in. I used wire with a diameter of 0.8 mm for that.

To make it clear:

For the original, I took 4 pieces of wire and glue each of them into a hole that I've drilled into the “torso”. For casting the armatures, I only use two pieces of wire. These two pieces are twice as long as one of the 4 wires used for the original. These longer wires are bent and will be placed into the mould before closing it. Then the molten metal will be cast into the mould and around the wire parts, so they will be fixed tight into the torso of the cast armature.

I made two different versions of the Schellert-armature that I called x-type and y-type.

The x-type has a full torso with head, chest Spine and hips. So while the size of the torso is fixed on this “dolly”, you can do a little variation with the length of the arms and legs (wire parts).

The y-type torso exists only of the head and chest without casted spine and hips. Instead of the spine and hips there are only the wire parts. On this version you can also do variations to the length of the torso, because spine and hips have to be formed out of the wire, so you can choose the length of the spine. So with this kind of armature, you can do miniatures with different sizes (see pic. 3 above).

So the trick regarding the wire parts is that when the metal is cast around them, they are perfectly fixed.

On the x-type armature, the two arms are made from a single piece of wire as well as the two legs.

On the y-type armature left arm and left leg on the one side and right arm and right leg on the other are each made of a single piece of wire.

If you have problems sculpting the torso or if you are unsure about the proportions, just buy the Reaper-dolly (the “advanced” ones), cut off arms and legs and use the rest as a starting point for sculpting the torso.

When the torso is done, just drill in holes and add the wire parts.

Then you have to make a drop cast mould with heat resistant rtv-silicone rubber from it. In relation to a full 30mm miniature, the part of the armature that has to be cast with white metal is quite small and this could be a problem for the casting process.

So the white metal that you’ll cast into the mould should have enough “pressure” to fill the whole cavity of the mould.

To achieve this I recommend an extra-large gate (sprue) as you can see on pic. 5).

If this gate is filled with molten metal, the weight of that metal will give the needed pressure.

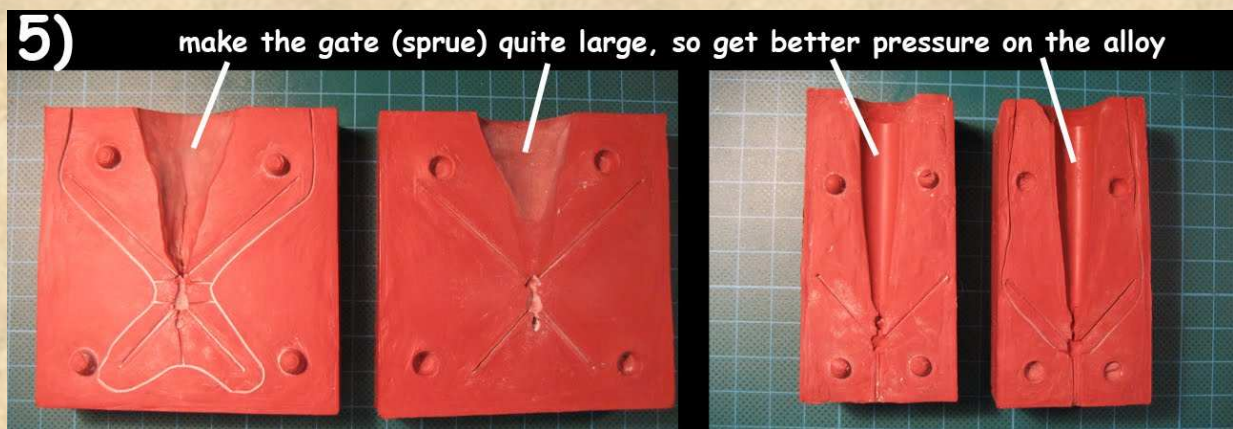

While making the mould I also recommend the following:

You have to set the parting line on the object you want to make a mould from to define, what’s in mould half A and what’s in mould half B.

Usually you try to set this parting line roughly into the middle of the object to get a well balanced mould.

But in this case you shouldn’t do this. Because later you have to put the wire parts into the mould it would be easier if the cavity that holds the wire is a little deeper.

This helps to prevent the wire parts from accidentally falling out of the right place while casting the molten metal in.

So try to create your mould in a way, where the wire parts are set predominantly into one mould half (see pic. 5b).

5b)

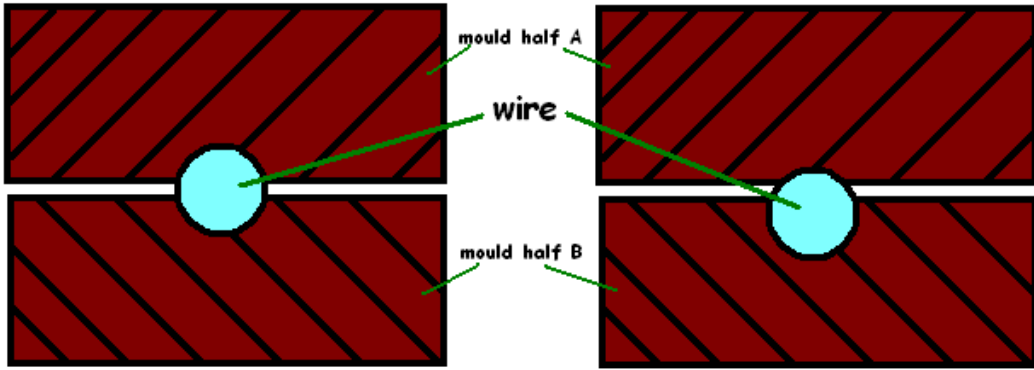

usually you would set the parting line of the two mould halves in the middle of the object

but regarding the wire parts I recommend to place them predominantly into one mould half because this makes it easier to place them into the mould later

When you've got your mould with cut in gate, sprues and air vents you can try your first cast. Before you cast the white metal into your mould, you have to place two bent pieces of wire inside the mould as you can see on pic. 6a and 6b).

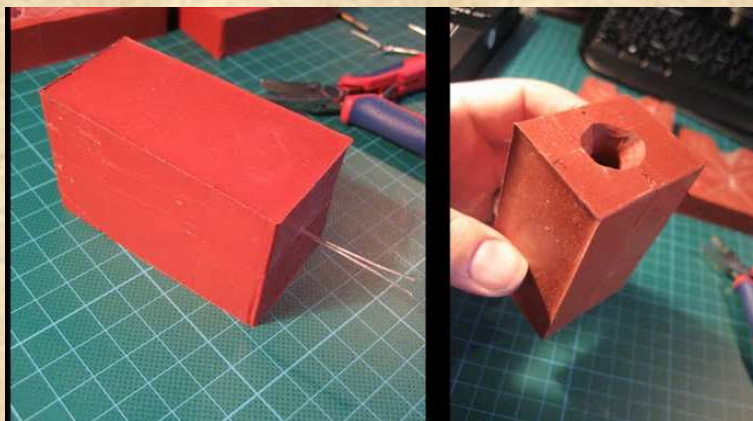

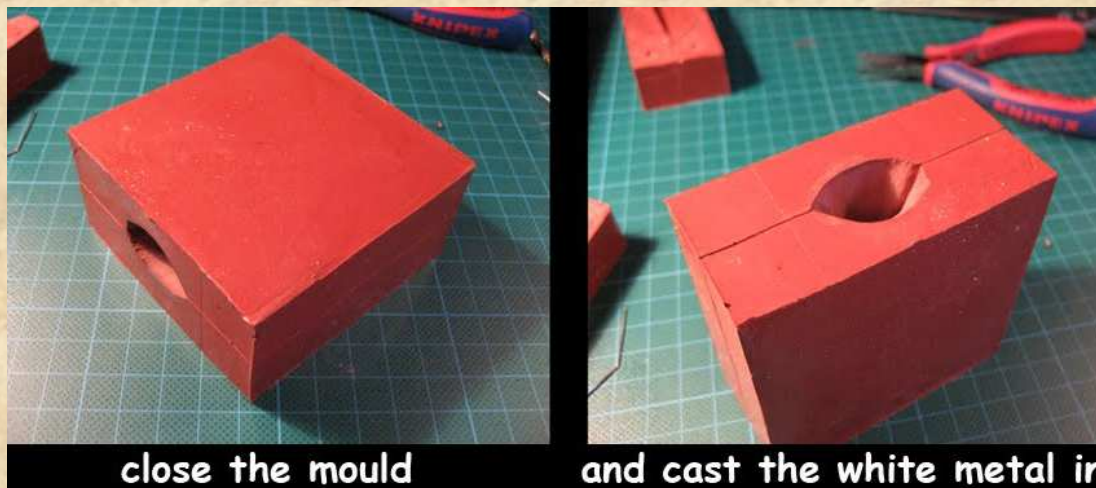
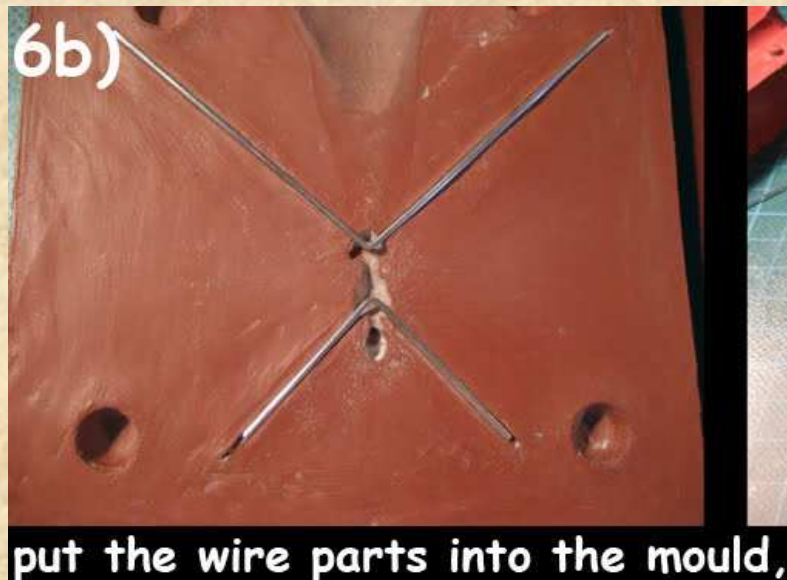

First you have to straighten the two pieces of wire. Then you have to bend them at the right point into the needed angle with a flat nose plier. You have to try a little bit to get the right angle. Place the wire parts into one half of the mould at the right position. Then carefully close the mould without letting the wire parts slip out of their positions.

Now fix the closed mould with rubber rings or a clamp or something like that and cast the molten white metal in.

The alloy I use contains lead. Personally I prefer this because the casted armature could be bent better when it contains lead and also the mould cavity is filled better because of the lead. If you don't want an alloy with lead because of health issues, try a lead free alloy. Personally I've got no experience with lead free alloys for casting this kind of armature.

When the metal has cooled down and you open your mould, the white metal should have enclosed the wire parts. Remove the gate and the sprues and your armature is done (pic. 7).

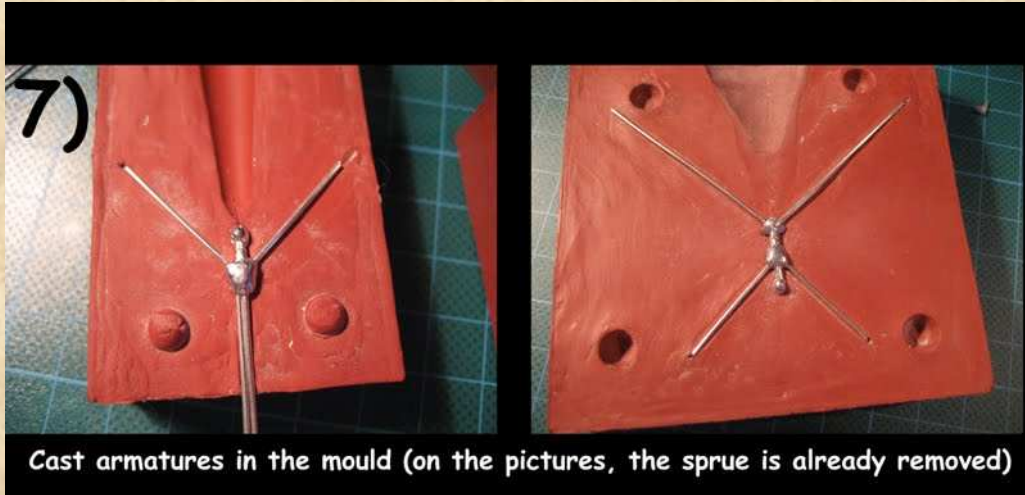

If your armature didn't come out right from the mould, it's maybe because the mould is too cold in the beginning, so just try again. After some casts, the mould should get its working temperature. If the results are still not good, try to widen the cut, where the gate "touches" the cavity and/or cut some additional air vents.

That's all. Now you got your mould and you can cast as many armatures as you like. If you got plenty of them, you can use them also to do a pose study, just by trying out some poses to see how they will look. Because you already have the basic shape of a human (head, torso arms and legs) it's easier to get an idea about how a miniature with this pose will look like.





## FINGER TOOL FROM A DENTIST PROBE

Sculpting tool made from a dentist probe

In this chapter I want to post just a small and simple tutorial about how to modify a dentist probe to get a sculpting tool that's quite similar to the "finger tool" I've talked before (see post about making sculpting tool tips from 1 mm steel).

But even this tutorial is quite simple, the tool you get is quite good. At least I use this tool quite often. So this tool might be ideal for those who didn't want to do all this tool-tip-forging and handle-making I've talked about in former chapters to get a sculpting tool.

As a starting point for this tool, you'll need a simple dentist probe like the one you can see on the following pic. 1). You can find it quite simple with Google or on eBay.

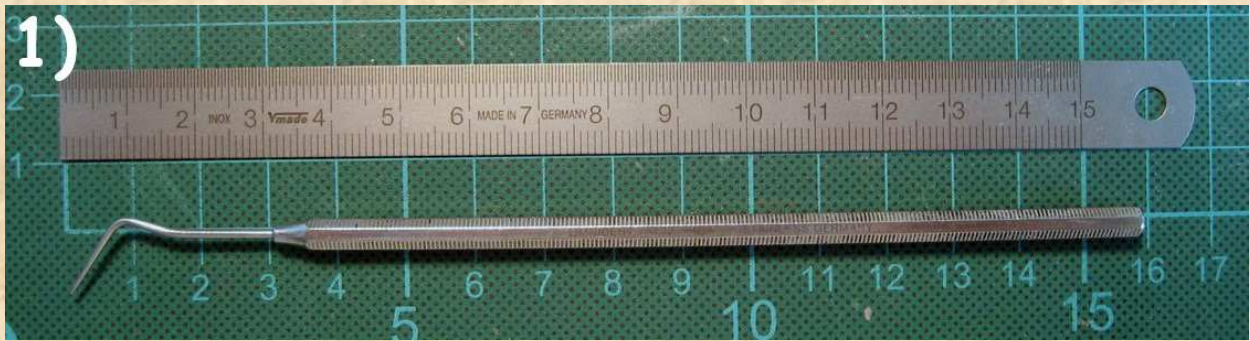

You have to cut the tip of this probe a few mm behind the first bending of the tip like you can see on pic. 2). Then you have to grind down the cut end of the tip to flatten it.

You can use a rotary tool with a grinding stone or just abrasive paper for that.



Just give it a smooth surface and round off all edges. Finally the tip should look like those you can see on pic. 3) and pic. 4). Be sure to give it a clean surface with no scratches left.

Work with fine abrasive paper or even better with fine abrasive pads and finally do some polishing to achieve this.

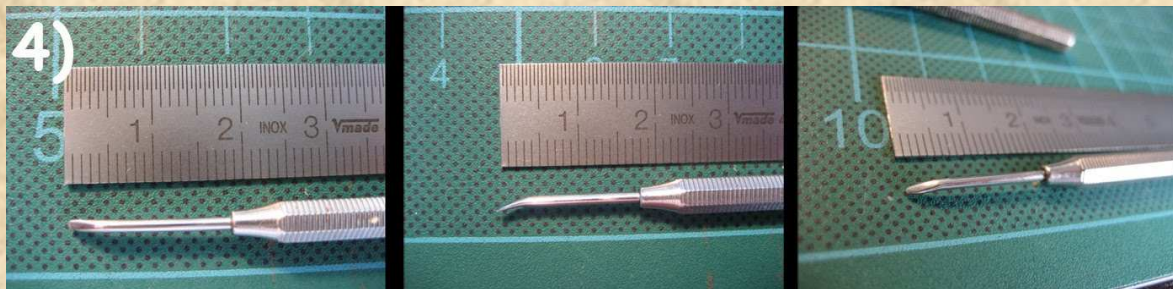

As I said before, this is a kind of “finger-tool”. It’s quite similar to the tip that can be found on the famous “Wax 5” but it is much smaller. So you can do quite delicate work with it.

On the next picture you can see a comparison of this tool and the “SG” dentist tool from Tiranti (“Wax 5”).



I hope you'll like this tool.

It's only a little bit of work but you'll get a lot with it.

## CONTACT LENSES BOX AS PUTTY STORAGE

Contact lenses box as storage for two part epoxy putty

Hi again,

In this chapter I just want to share a little idea with you, that I came across even it's not a "sculpting tool" in the literal sense.

Sometimes I have to take some sculpting tools and stuff with me, when I'm on holidays or somewhere else away from home and want to do a little sculpting there.

For these occasions I often thought about how to take this two component sculpting putty with me, because I didn't want to carry the complete box of green stuff or procreate with me.

So I had a look for some kind of small boxes to store the putty in while travelling.

Because my wife wears contact lenses, I've got the idea to use these contact lens boxes for this purpose and it works quite well.

The advantage is that you have just a single storage, with two separated little boxes and with separated covers. The covers have different colours (or are marked in another way) so you store the two putty components perfectly and you can always see, which component is in which box.

And this box is quite small and easy to store in a bag without taking a lot of space. The amount of putty that can be stored is more than you would need for a 30mm miniature.

Even at home it might be useful for storing brown stuff because except to those who do the whole miniature with brown stuff usually you only need small amounts of brown stuff while sculpting.

Well that's not a big idea, but I found this very useful, especially when I didn't want to carry a lot of sculpting stuff with me.

So just take a 1 mm and a 2 mm Schellert tool and this box with some putty in and you've got all you need for sculpting.



## SCULPTING TOOL MADE FROM A HOBBY KNIFE BLADE

In this tutorial I want to show you how to make a very nice sculpting tool from a hobby knife blade.

Maybe some of you already know this or even use this kind of tool because it is quite common.

Even Tom Meier who is known to use only quite a few different tools to do his ingenious miniature sculptures uses this tool. If you want to know, how exactly Tom Meier's tool looks like, have a look on his blog. He has posted a photo of his tools there.

It is quite simple to make this tool. All you need is a blade for a hobby knife (x-acto-style), some sheets of abrasive paper and a little patience. A rotary tool with a grinding tool would be helpful.

All you have to do is to blunt the edge of the blade over the whole length.

The blade's tip is too pointy for sculpting. So you have to grind it down and to give it a slightly rounded shape. Instead of doing the whole process with the abrasive paper, you can try to carefully break off the tip of the blade with fine flat nose pliers and then to round up the line of breakage with the abrasive paper.

Finally you also have to grind down the sharp edges on the flat sides of the blade and to round them up, so they won't leave ugly marks in the putty while sculpting.

On the following pic. 1) you can see how to do this.

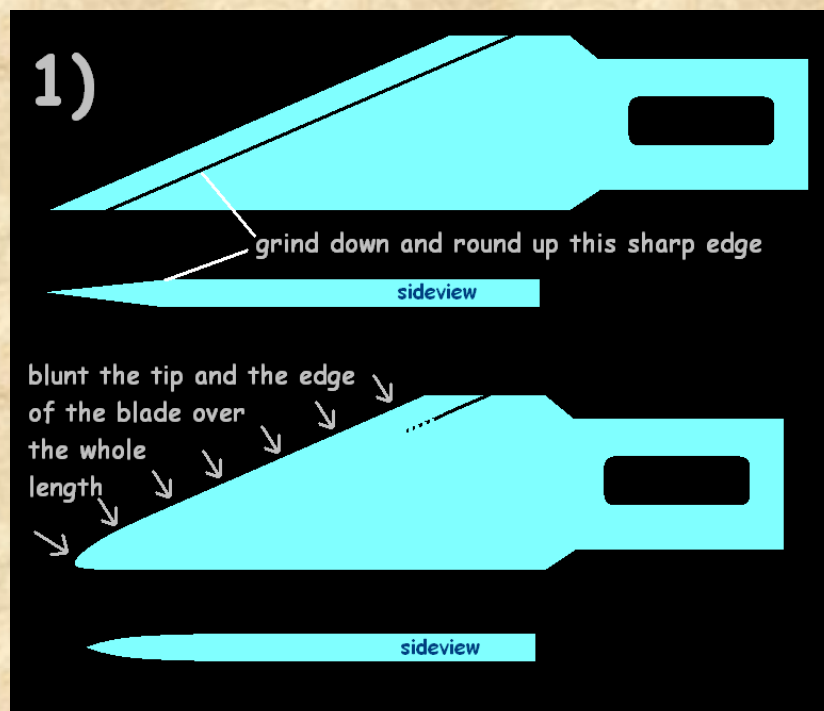

Just refine the edges and the surface of the grinded blade with very fine abrasive paper or abrasive pads. You can finally polish it, if you like.

This blade has to be placed into a holder for those hobby knife blades (obviously). You can also use a SCHELLERT-tool as a holder for this sculpting tool tip.

That's all. This is a nice tool for basic sculpting, like blocking out the rough proportions of a miniature and for blending layers of green stuff or procreate together.

---

## STAMP TOOLS – PRESS MOULDS

This time I want to talk a little bit about what I called stamp tools.

In a former tutorial I told you how to make the “rivet tool” (see tutorial about making 1 mm tool tips). This rivet tool is nothing more than a tiny tube that makes rivet-like shapes if pressed down into the putty like a stamp. So the rivet tool is a most basic kind of stamp tool.

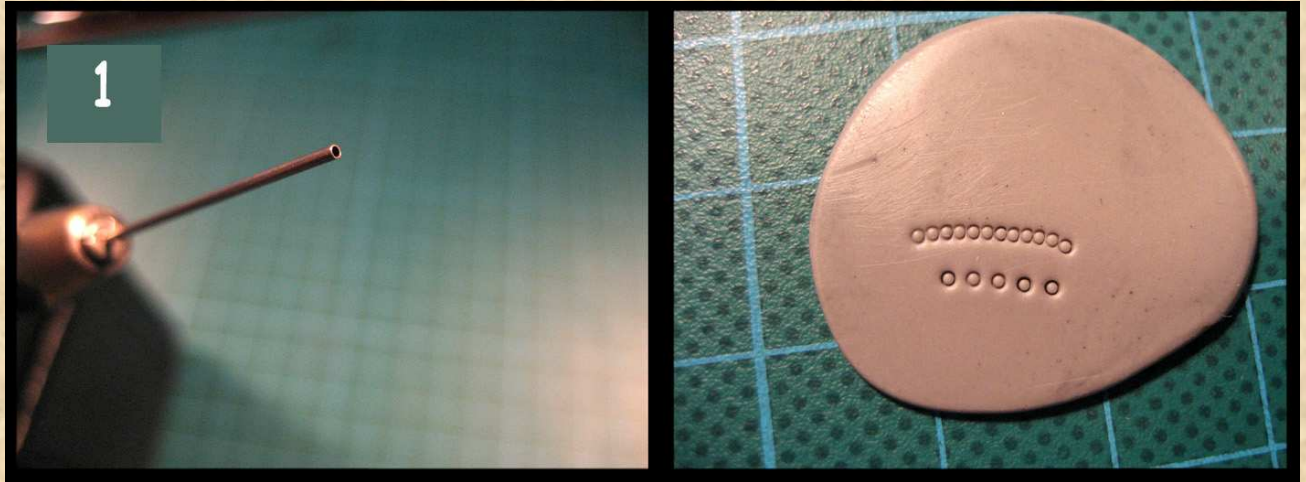

Basically a stamp tool is an object with some kind of structured or engraved surface. If you press it on or into your putty, it leaves a mirrored-inverted mark on the putty. By using stamp tools, you can save a lot of time and you can do details that are nearly impossible to achieve by trying to do them by hand (unless you are Tom Meier).

Especially if you need a homogeneously structured surface (like some kind of rough fabric) or if you need a lot of exactly the same pattern (like a symbol on several shields or on the armour) stamp tools can save your day.

But one advice right from the beginning: Don't overdo using stamp tools on your sculpture.

Stamp tools are a fine addition to your sculpting tool set, but the results are the best if

In general a lot of things could be used as stamp tools. You should have a look for small objects with interesting surface structures or with engraved objects and you have to experiment a little by pressing them on your putty to see, what effect could be achieved with them.

For example I found a piece of rubber that has an interesting rough structure on its backside.

When I pressed it on my procreate putty, I found out, that the result looks exactly like braided willows (the kind baskets are made of).

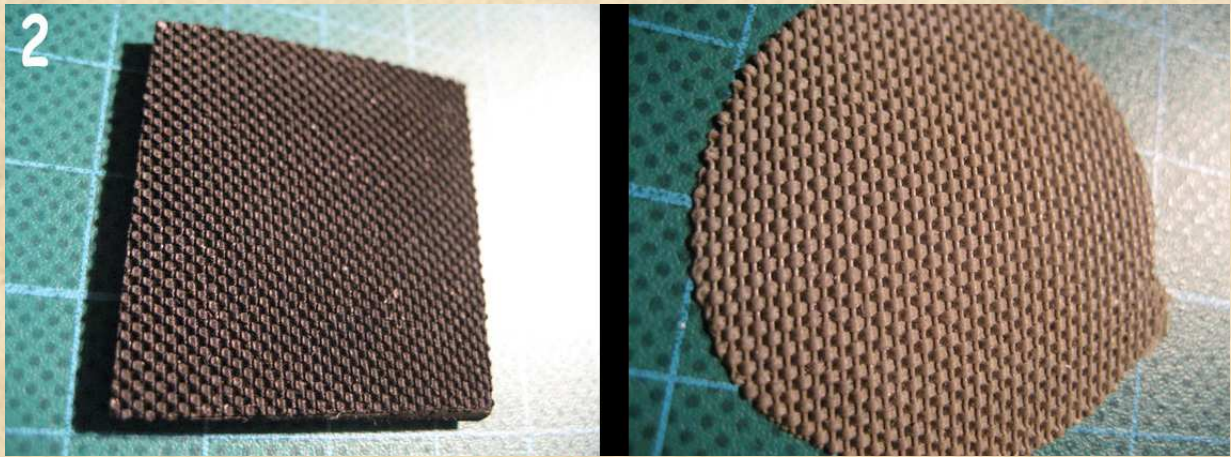

Other interesting structures could be achieved by using for example rough sandpaper (abrasive paper) that is pressed onto the putty.

Or have a look on this structure:

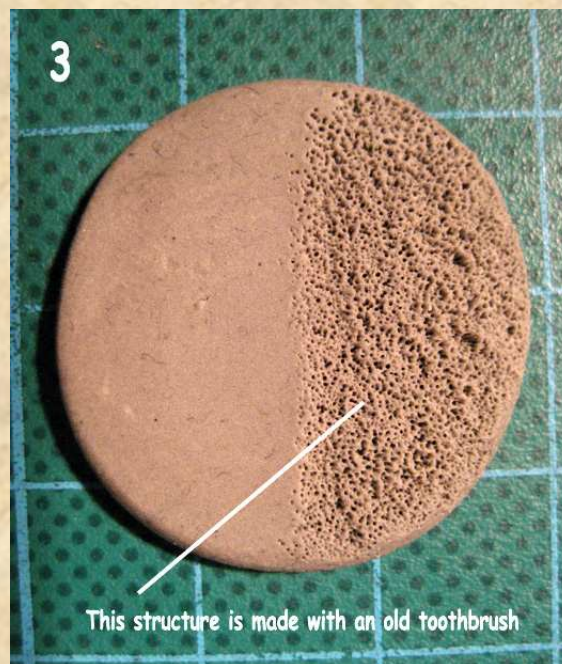

I used an old toothbrush for that.

If you think a while about this technique, I'm sure you will find some nice uses for that, so I won't talk too much about all the possibilities for using stamp tools.

Beside stamp tools there are so called press moulds. As the name indicates, a press mould is a kind of small mould (usually a one-piece-mould) where the putty could be pressed in to give it a special shape. So as the idea is the same as for the stamp-tools, there is no really difference between a stamp tool and a press mould.

Maybe you can say, the difference is how to use it. If you press it into the putty, it is a stamp tool and if you press the putty into it, it's a press mould. Generally a press mould

is larger to form the whole shape (like a complete shield or a complete weapon) while the stamp tool is usually used to form smaller things like a part of a structure (rivet). Anyway, those categorisations are only of academically interest as both are sculpting aids that use the same principals.

So in the following, I want to give you a few examples about what can be done with stamp tools (from now on I will only say "stamp tool" as a synonym for stamp tool and press mould).

## **THE CELTIC PATTERN**

This is a little bit more sophisticated way to make a stamp tool.

The idea was to use a technical trick to get some details that are hard to sculpt by hand. I wanted to have a Celtic-pattern-like structure on the clothes of a dwarf that I've sculpted. Celtic knot-like patterns are beautiful, but hard to sculpt, because it's a kind of braided structure that has to be exactly symmetrical to look good. And to sculpt such a symmetrical structure by hand is really hard.

So I thought about a way to get a perfect symmetrically Celtic knot pattern. Then one day when I was walking home from the city, I passed a shop where you can copy keys and where you can order these small engraved name plates made of plastic that are placed beside the doorbell. In the shop-window, I saw examples of these name plates and I saw, that not only letters can be engraved on these plates, but also little symbols and icons. So I went into the shop and ask how these plates are made.

It is quite interesting. The plates are made with a machine that uses a laser to carve out the letters and icons from the plastic sheet. Even more interesting is that nearly every black and white icon, drawing or pattern can be carved out of the plastic. You just need the drawing or icon in digital form (like .jpg, .tiff or even better some vector graphic file formats from corel-draw or inkscape). The black parts will be cut (or better: engraved) while the white parts remain.

The laser engraving machine is connected to a PC that runs a special graphic software. The digital graphic (tiff, jpg, ...) will be imported into this software. Then the size for the output and the "deepness" for the engraving (that indicates, how often the laser "runs" over the same spot) are set.

After that just the press of a button starts the engraving-process and the desired shape will be cut out of a large sheet of plastic (some of this plastic sheets have a thin metal coat to give them a metal-look. That's why on the following pictures they seem to be made out of brass).

Because you can adjust the size of the desired shape in the software, you can engrave really small structures. Just make your original graphic a little larger to get a clean shape. Of course it's the best to use a vector graphic file format because it can be scaled without loss of quality.

So I came to the idea, to create a Celtic knot pattern with a graphic software on my pc and to use it to get such a carved out plate from it.



So I started with making the Celtic pattern, you see on the next picture:



You don't have to fight with software to get this done. There are several kinds of "KnotCreators" available on the internet. Some of them are web-tools, where you don't need to download and install anything. You can directly start to create a Celtic knot online.

Try Google to find them.

With this pattern I went to the shop and the guy there made a "name plate" from it (see next pic.). The guy was very friendly and interested in what I wanted to try, so I only paid a few cents for that plate. But I guess the usual price for that would be about a few EUROS.

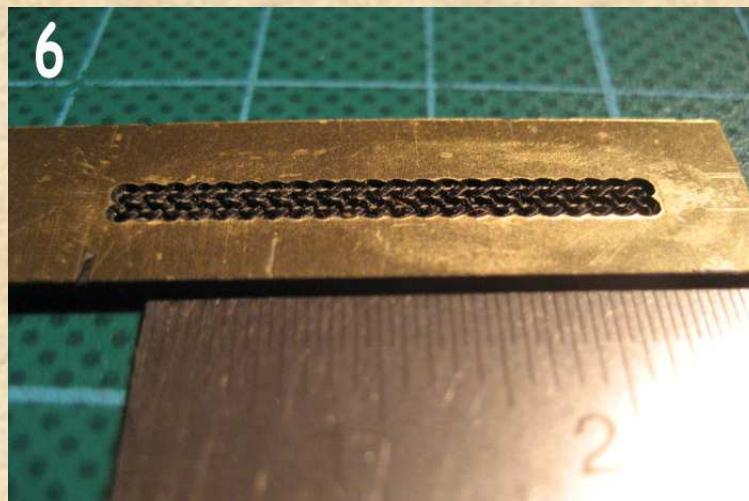

The rest of the story is quite simple. I mixed some putty (procreate in this case) and pressed it onto the plate.

Then I sprayed **!!! cooling spray !!!** onto the putty. This trick makes the putty quite hard for a few seconds.

This short time I used to peel of the putty from the plate. Don't use too much cooling spray.

If the putty gets too frozen, it could break.

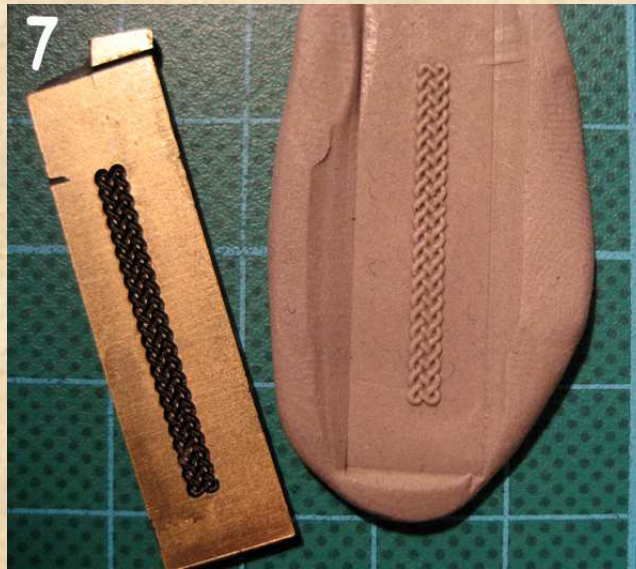

After that I cut the putty stripe with the new Celtic knot structure into shape and fixed it onto the dwarfs clothes.

The whole thing looks like you can see on the next picture:



I used the same “stamp” to create a decorated sword scabbard for a alfling sculpt as you can see on the next pic.

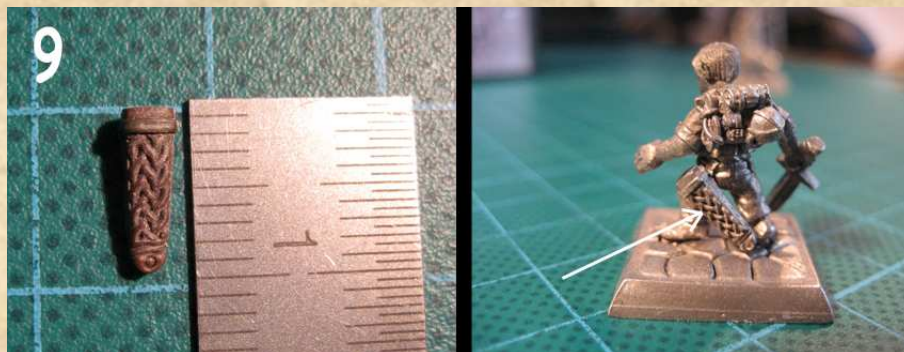

## THE “BOOK OF GOLD”

As the Celtic knot pattern worked quite well, I just tried another stamp tool. For the dwarf I’ve sculpted, I wanted a small book that is bound onto his backpack. The book should have an embossed readable title and some embossed decoration. The “title” should be “GOLD” (as a tribute to the dwarfs in Terry Pratchetts “Discworld”, who are quite mad about gold)

So first I made a simple graphic of the book cover with the word “gold” on it and some decoration you can see left on the next picture.

Then I mirrored this graphic before I created an engraved plate from. That’s important. Otherwise the stamp tool would have produced a book cover with mirrored letters.

The rest is exactly the same like I’ve explained for the Celtic knot pattern. In the end it looks like that:

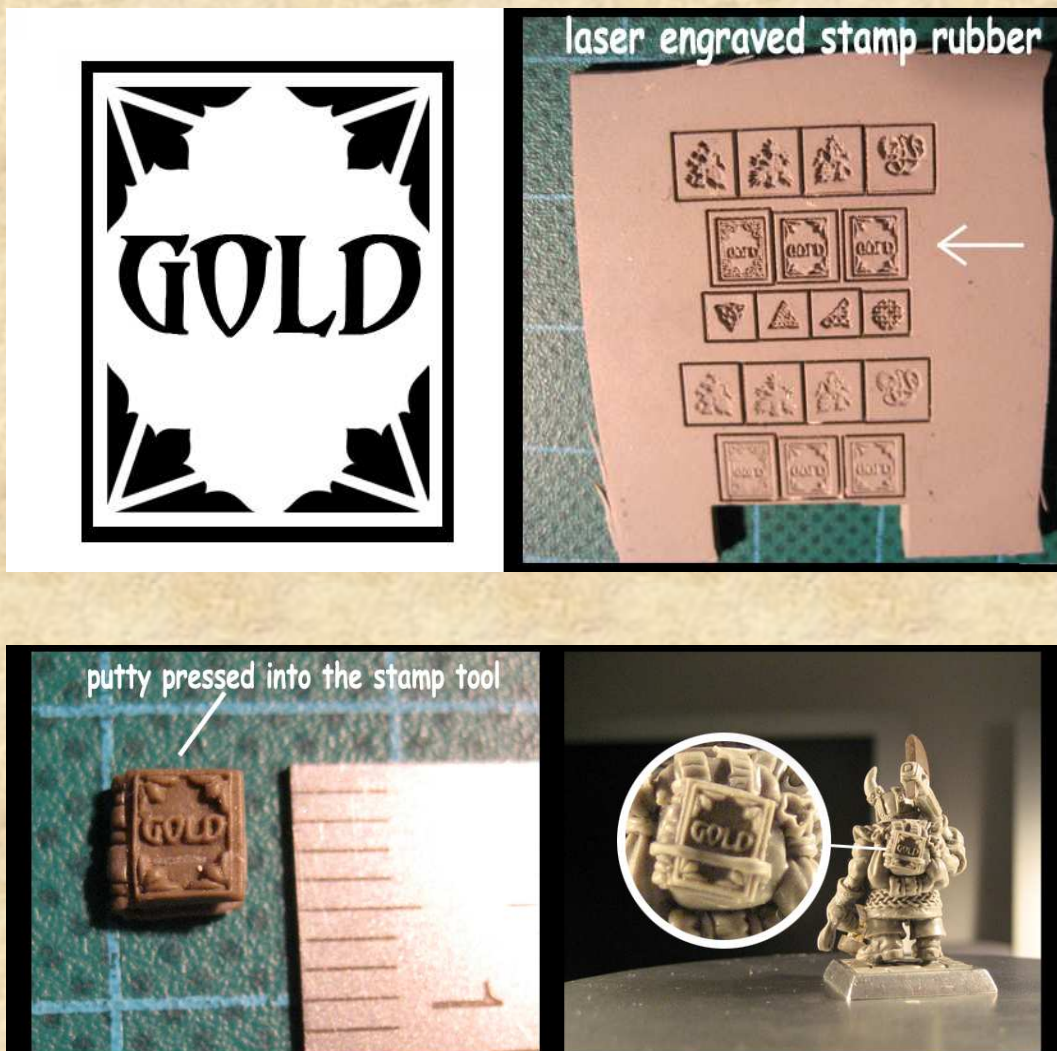

As you might have noticed, for his „stamp“ I didn’t used the hard plastic to engrave the pattern in. The grey material, you can see on the picture above is the rubber, that real stamps are made of (I mean those that work with colour on paper).

This material can also be used, because with those engraving machines not only name plates can be cut, but also traditional stamps with letters or symbols. Because this rubber is more flexible than the plastic for the name plates, in some cases it might be better to use this rubber.

### OTHER IDEAS FOR STAMP TOOLS

Once you got familiar with the principles of the stamp tools, you'll discover a lot of things that can be done with stamp tools this way.

For example you can make a stamp for tiny insects like spiders or little lizards. This would be a nice addition to the base of a sculpting (or even on a plate armour or shield), see the next picture:

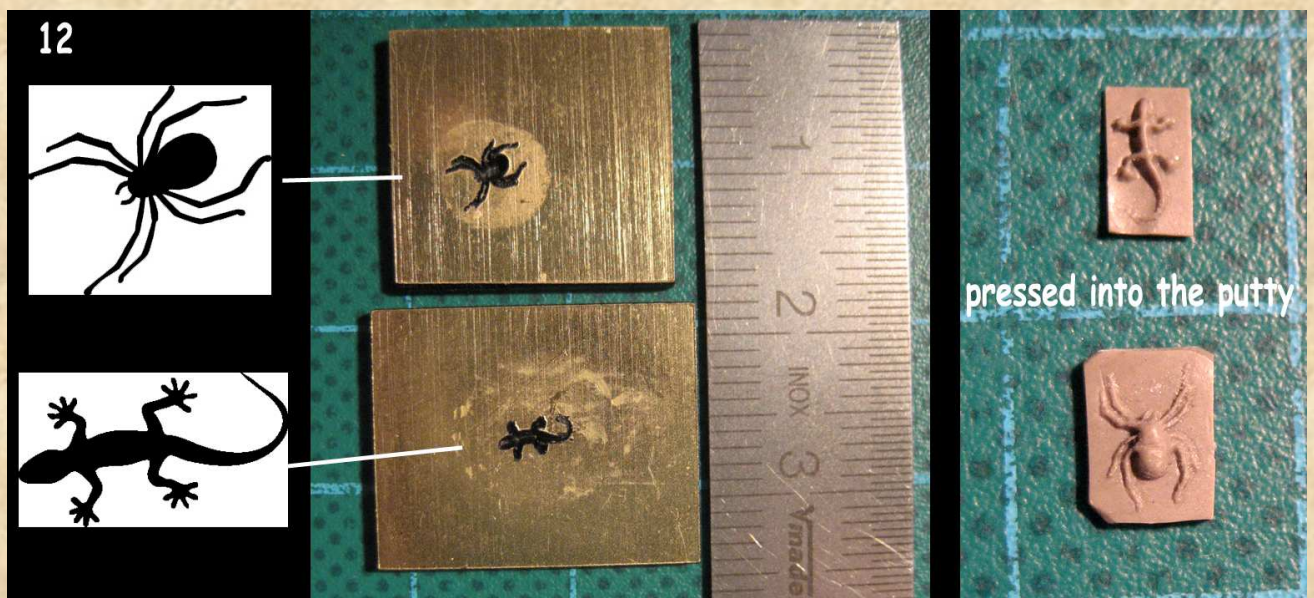

For shields and armour the shapes of dragons, unicorns eagles, griffins are ideal.

Here are some examples I found on the web:



Basically you need a quite simple black and white drawing.

You can draw this on your PC with a 2d graphic program. If you don't want to draw them on your own from scratch, here's a tip for you: Have a look for "**dingbats**" and "**wingdings**" on Google's picture search.

Here you'll find tons of little icons and symbols that can be used perfectly as a template for a stamp tool. There can also all kinds of mythical creatures be found.

But be sure to respect the copyright.

So only use those stuff, that is open source or free to use. Or use it only for inspiration to create your own stuff.

If you make very small stamp-tools, it might be useful to fix them on a kind of handle. For that I used a simple piece of wood and glued a stamp on each side.

One tip for that: Make a sign (like a little dot or something like that) on the handle that indicates where the top of the stamp is. Otherwise you would have problems to place the stamp exactly on the putty.

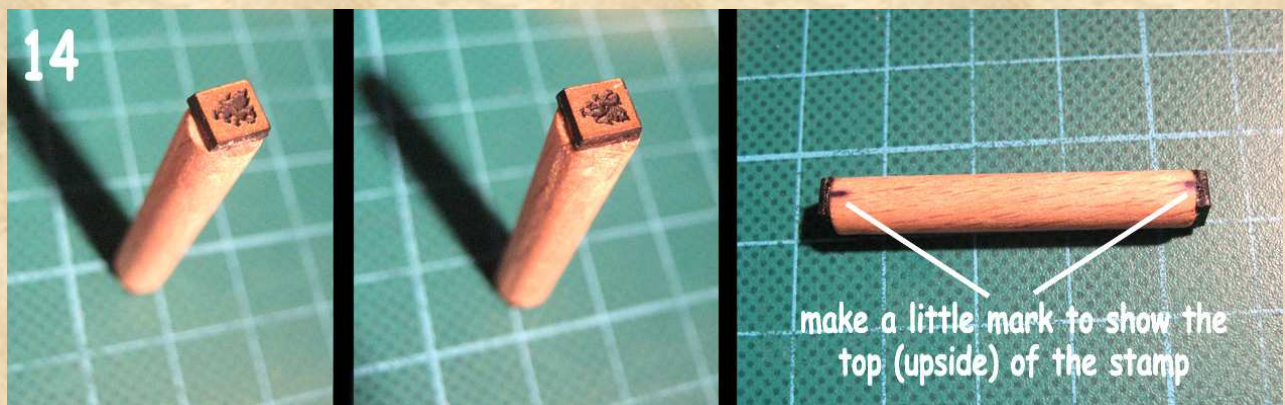

I guess that should be enough to give you an idea about what this technique could be used for.

I confess that the stamps you can see in this tutorial are really small. You don't have to do them as small, but I wanted to test, how small I can go while still getting good results.

In some cases, the stamp could be a start for a detail that has to be worked over to get good results.

So always have a look on your "stamped" pattern, if it could use some improvements by hand.

For example the little lizard you can see on the picture 12 above might need some improvements especially on its feet.

On the next pictures, you can see some more stamped pattern for inspiration.

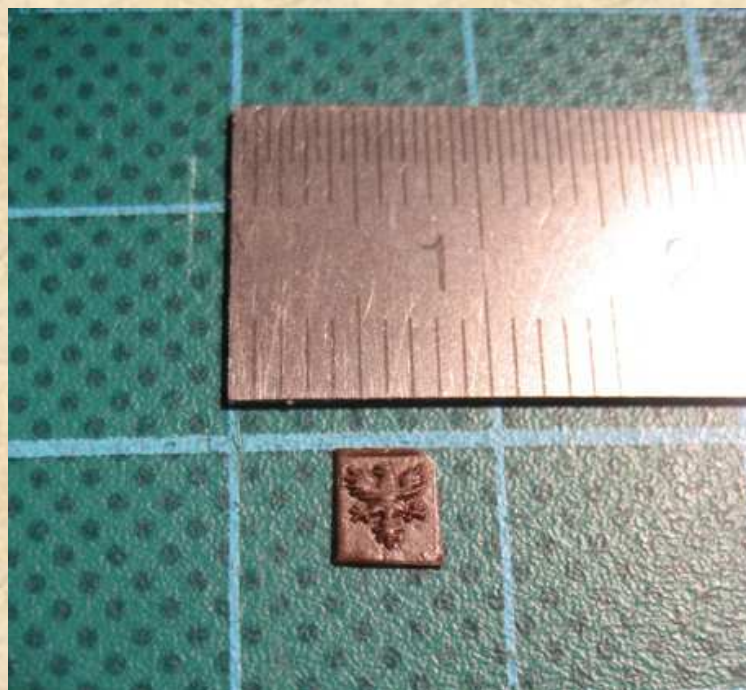
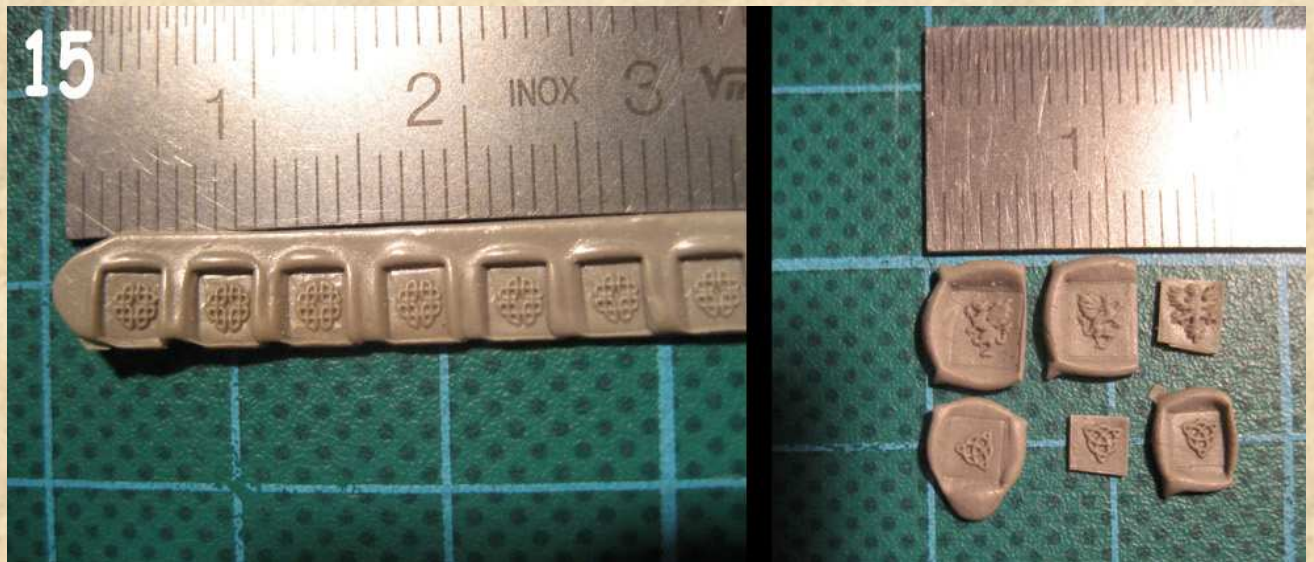

If you like this kind of technique but you don't have access to such a laser engraver, you can simulate this effect by using Fimo or Super Sculpy to make your press mould.

Just roll out flat a piece of Fimo/Sculpy and press holes and patterns into it by hand. If you got your (negative) structure, just harden the Fimo/Sculpy in the oven and your press mould is ready to be used.

Of course you could also use Greenstuff or Pro Create for that, but if you use Greenstuff or Procreate for your sculpting and also for the pressmould you might get the problem, that the putty sticks too much in the mould when it is made out of the same material. So better use Fimo or Super Sculpy for the mould, because Greenstuff and Procreate will stick much less in it.

Scibor made a nice little tutorial about this way to make a press mould with lots of pictures that explain this technique much better than my words. You'll find it on his website in the articles section:

<http://www.sciborminiatures.com>

If want to do a larger press mould maybe to reproduce larger parts, there's another material a press mould could be made of:

If you have a look around, you can find a special two-part silicon rubber. This rubber is made of two components that are not fluid, but have a putty-like consistence.

When you knead these two parts together, the silicone will harden in a few minutes to a rubber-like consistence. So you can use this kind of silicone to create press moulds quite fast even those with a more complex shape and undercuts.

Unfortunately this silicone rubber isn't cheap. But you can also try eBay for that. These kind of knead-silicone is available for hobby and modelling purposes but you can also find them in the dentists supply (eBay). If you want to buy some of this keep an eye on the final hardness (shore-hardness) I recommend not to use those silicones that are too hard, because they aren't as flexible and might break faster especially when it comes to undercuts.

You can sculpt a small pattern or detail with greenstuff or procreate once and then make a press-mould to reproduce it several times with this kind of knead-silicone.

One last tip:

When you make your own press mould or stamp tool, remember that it will work like a stamp.

That means the mould has to represent the negative of would you would like to achieve. You have to keep this in mind otherwise your pattern will be "mirrored" later and this is something you won't like especially if your pattern contains letters.

So if you've created your desired pattern in Photoshop or Coral Draw (or similar) be sure to "mirror" it before you hand it to the guy with the laser engraving machine.

=====

## LARGER SCALE SCULPTING TOOL

When I started this blog here, I made it about tools for sculpting in small scales like 30mm or 54mm scale. But there are also a lot of people around, who do sculpting in a quite larger scale. Especially comic-style characters are quite popular. A lot of these people do their stuff with super sculpey or super sculpey firm (grey). The height of these Marquette's is 15 cm and above. I found this interesting and so I would like to try out some sculpting in a larger scale on my own.

For that I thought about a simple sculpting tool for getting started with larger sculpts. I had a look on the web for tools that other people use for that kind of sculpting and decided to make my own two sided tool.

In the end it is just a two sided tool made of a stainless steel rod with 5 mm diameter and with a "finger-tip" on one end and a "sculpting-knife"-tip on the other.

I made it this way:

First I took a stainless steel rod with 5 mm diameter and cut of a piece with about 17 cm length. Maybe it's a bit too long, so you do it just a bit shorter.

After that, I fixed the rod into an electrical drilling machine, set it into rotation and pressed it slightly onto a grinding machine, like you can see on the next picture. By doing this, I formed a pointed tip on one end of the stainless steel stick.

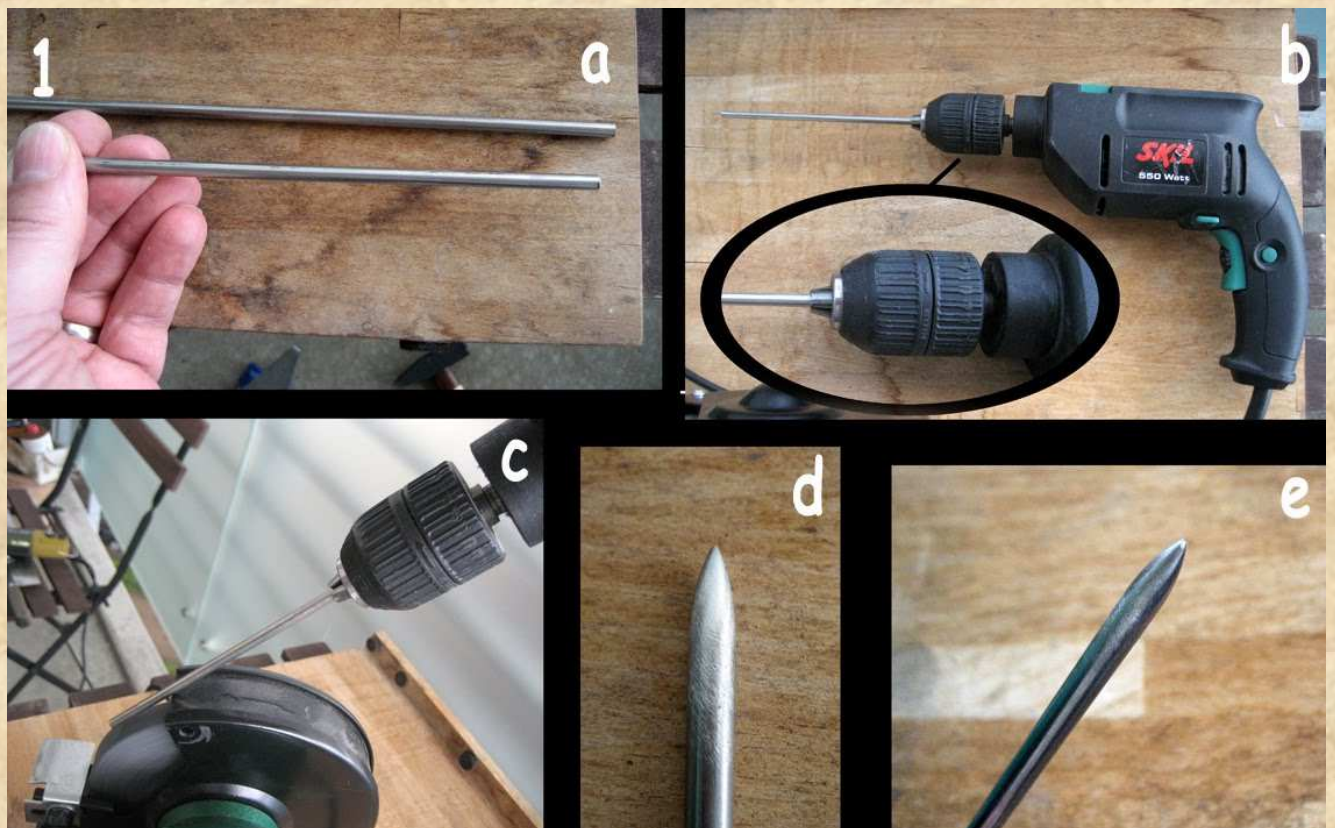

After that, I just flattened the end of the stick. To do so, I heated the pointed end of the stick up until it glows and then hammered it down on an anvil. It's just the same procedure as I've explained for making 1mm tool tips (look there: "the finger tool")



beside the fact, that this time the steel has a much larger diameter. The flattened end looked like that:

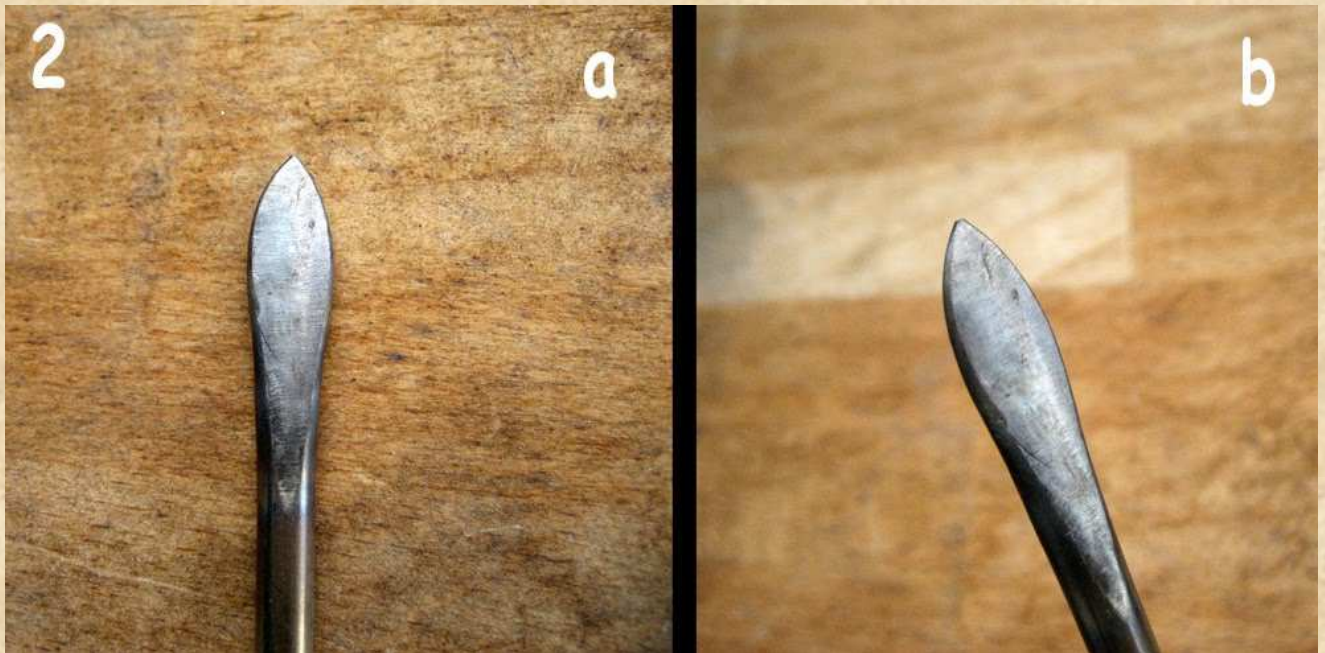

Then I moved to the other side of the stick. This end, I grinded down a bit as you can see on the next picture. The idea here is to give the end already the rough shape of the later blade of the sculpting knife. I use also the grinding machine to get this done. It's better to "pre-shape" the steel that way because it saves you a lot of work later and helps you, to get the right shape.

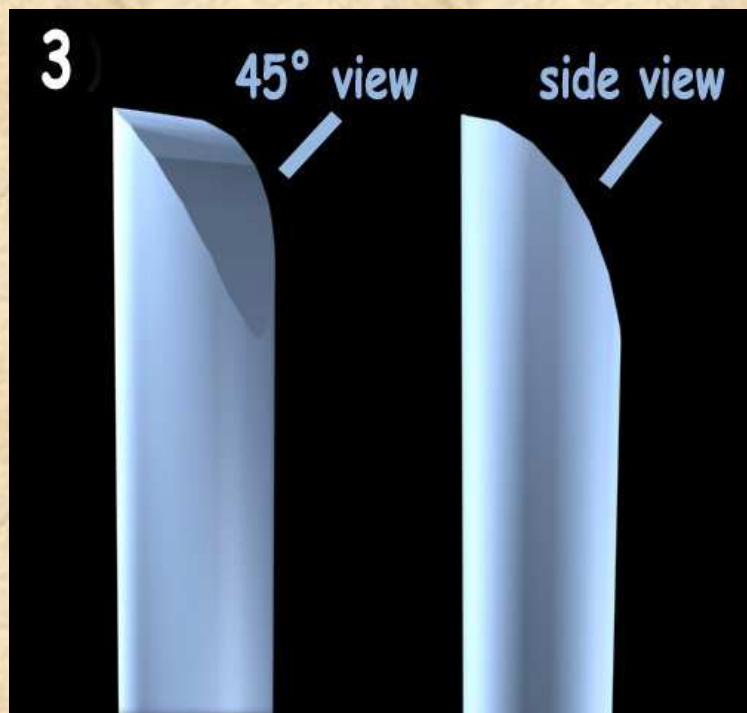

After that, this end was also flattened with heat, hammer and anvil. Again it's the same as I've explained in my post about the 1mm tool-tips for the "sculpting knife" just in a larger scale.

The flattened end looks like that:

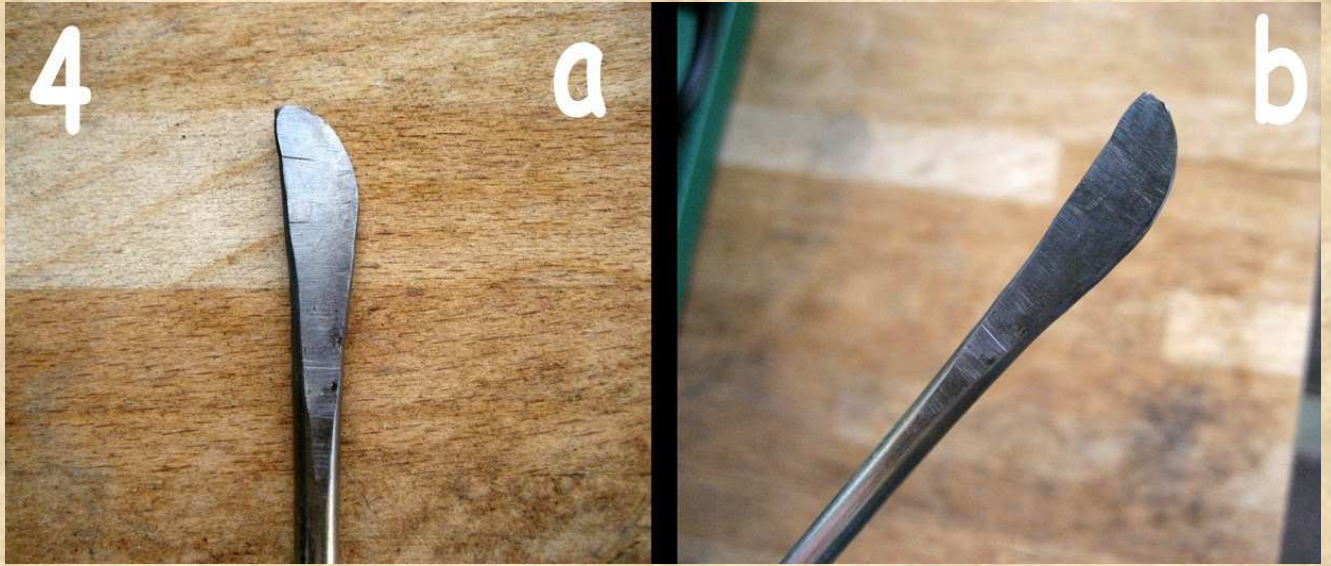

After doing the forging work, I had to refine the two ends of the tool with the grinding machine. After that, the tool looked like that:

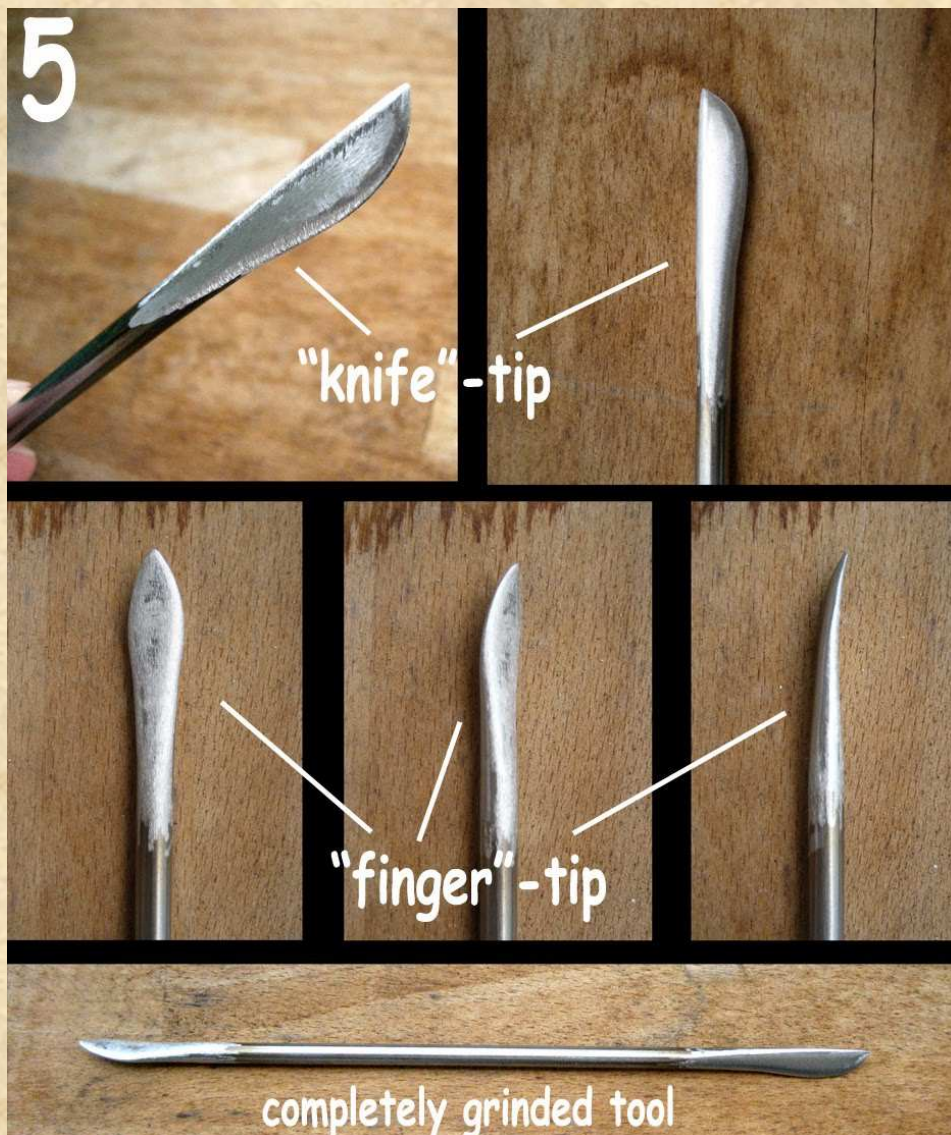

Finally I used abrasive paper and a polishing machine to remove all scratches from the tool and to give it a clean surface. In the end it looked like you can see on the next picture.



After that, the new tool was done. As I said before, it has a diameter of 5 mm, which is ok for most hands (except troll and orc).

I made two alternative versions of the tool.

The first alternative was made of stainless steel which profile wasn't round but hexagonal (like a screw nut). The screw-wrench size of this hexagonal steel rod was also 5mm which makes it a little larger in the hand than a round 5mm rod.

Beside that some people prefer a hexagonal grip on their tools for having a better control over the tool.

If you want to use such a hexagonal steel rod, I suggest grinding down the tool ends to a round shape before forging the tool ends. This helps to flatten the ends more evenly. The tool from the hexagonal steel rod looks like that:

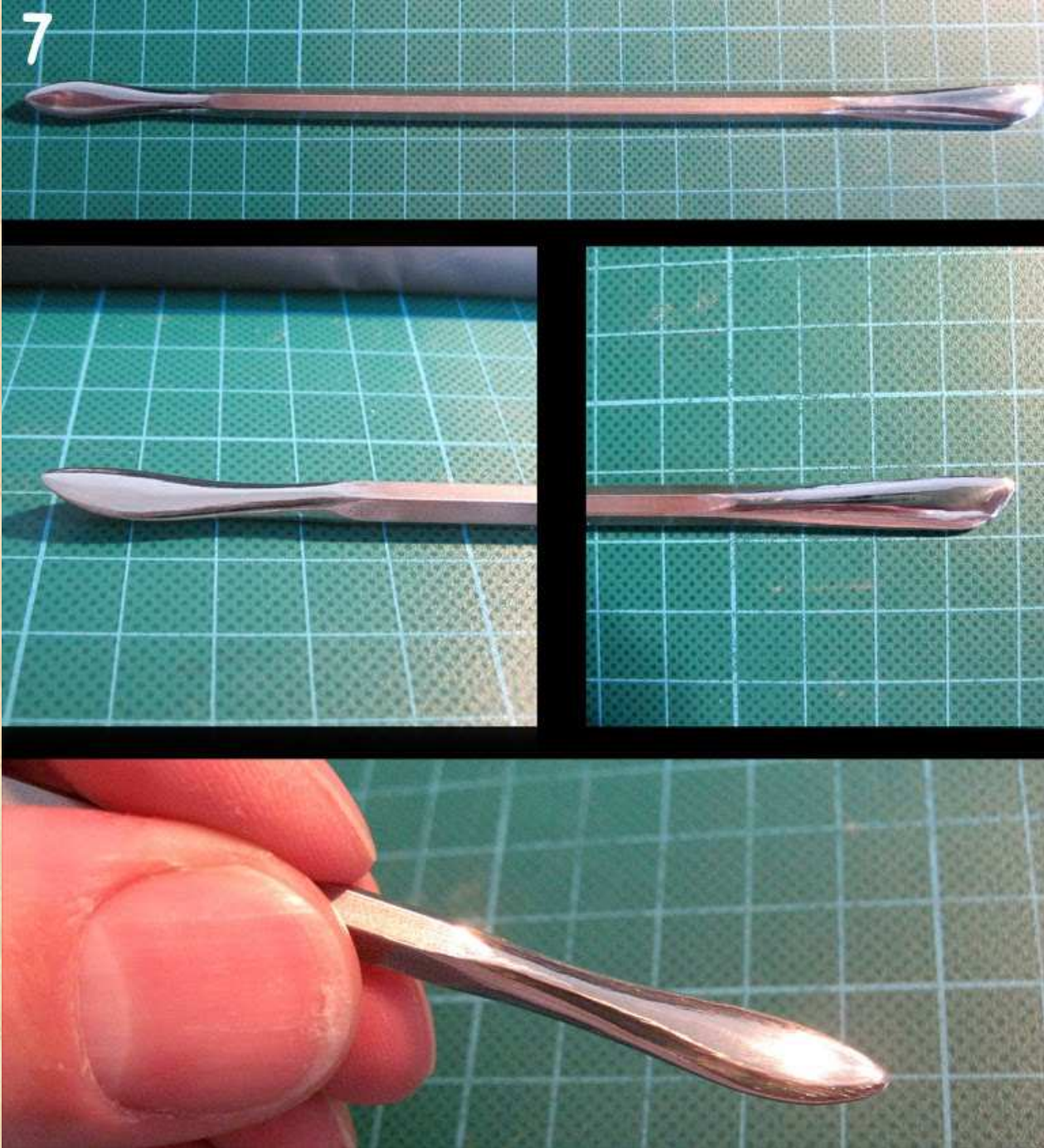

For the other alternative I used a round profile stainless steel rod again, but this time smaller with a 4 mm diameter. There's nothing special to explain here because the procedure is the same as I've explained for the first tool. This tool looks like that.

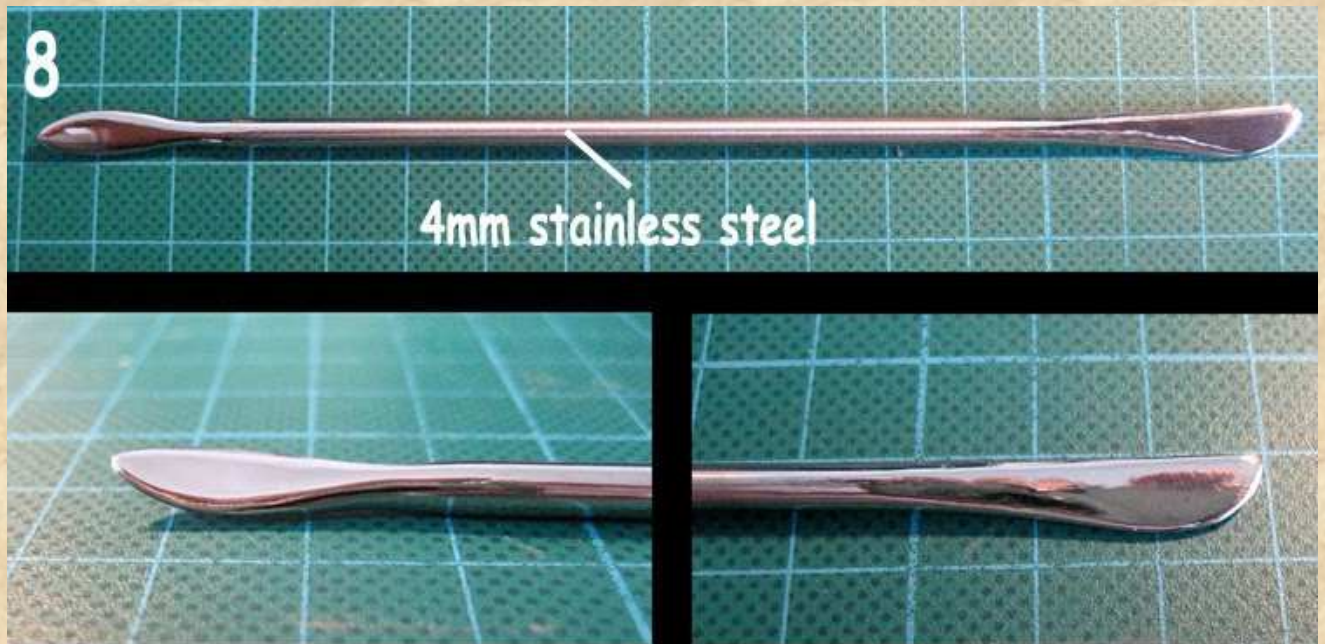

So the tools I've made by now have a diameter or "grip size" of 5mm and 4 mm. Maybe you prefer tools with a larger diameter at least at the handle. If so, here are two ways to get a thicker handle on these tools:

1.

You can just "add" a larger diameter to this tool, by using a heat shrink tube (I hope, this is the right word in English for it).

A heat shrink tube is a tube / hose made of some kind of rubber-like material. If heat is applied on it, the diameter of this tube shrinks down. There are different kinds of heat shrink tubes around. I suggest getting those with a high shrinking ratio. I took one with a 4/1 shrinking ratio. That means, the diameter of the tube was originally 16 mm. After heating it up, it shrinks down to 4mm diameter. The shrinkage in the length direction is much less. It's less than 10% (at least for the heat shrink tube I use).

I also choose a heat shrinking tube with hot glue already applied to the inside of the tube. This helps to fix the rubber grip very tightly to the steel.

I bought this heat shrink tube on ebay.

I cut up a piece of the tube that is just a little bit longer than I want for the final "grip". I just pulled it over the tools handle and applied heat on it. I used a heat gun for that like that. That's a kind of hard-core hair dryer that produce much more heat than a usual hair dryer. I guess you need about 120 to 150 ° (Celsius) for activating the shrinkage.

While applying the heat on it the diameter of the tube starts to shrink dramatically until it sits on the metal tool very tightly (even more because of the heat glue inside the tube).

Because I choose a quite large heat shrink tube, the final diameter of the tool grip was quite large. So after that my new tool has a diameter of about 8 mm, that's the same as the handles of hobby knives like x-acto or Martor etc. Finally you just have to cut of a part of the tube away on each end, if it is too long. The final tool looks like that:

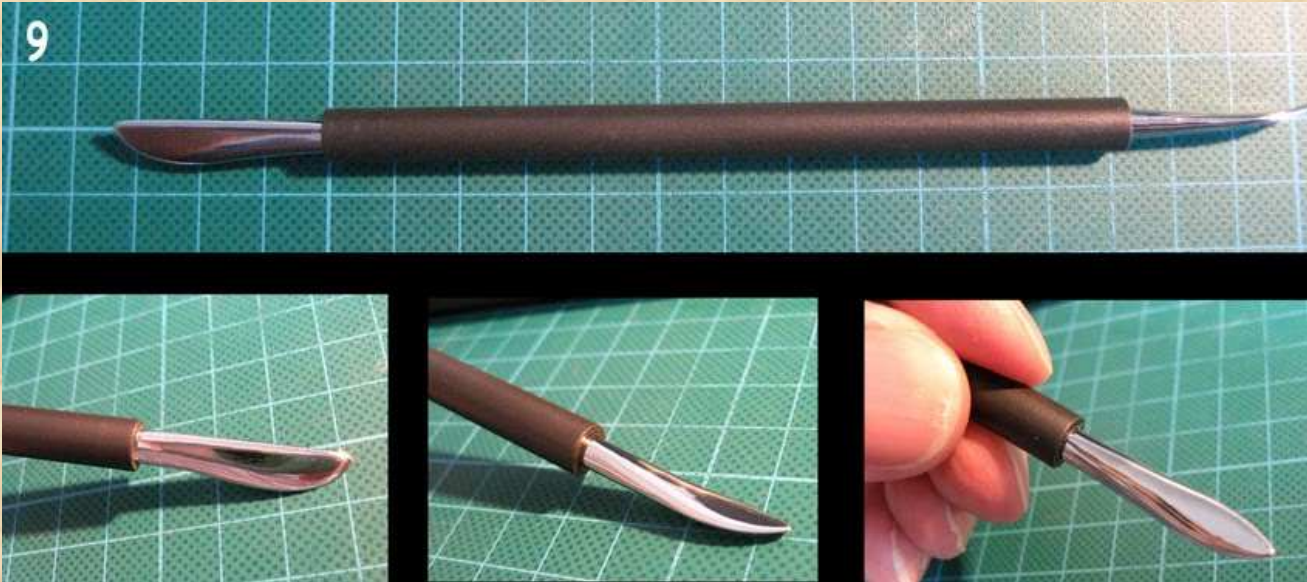

Here you can see the relation of the original heat shrink tube before and after heating it up:

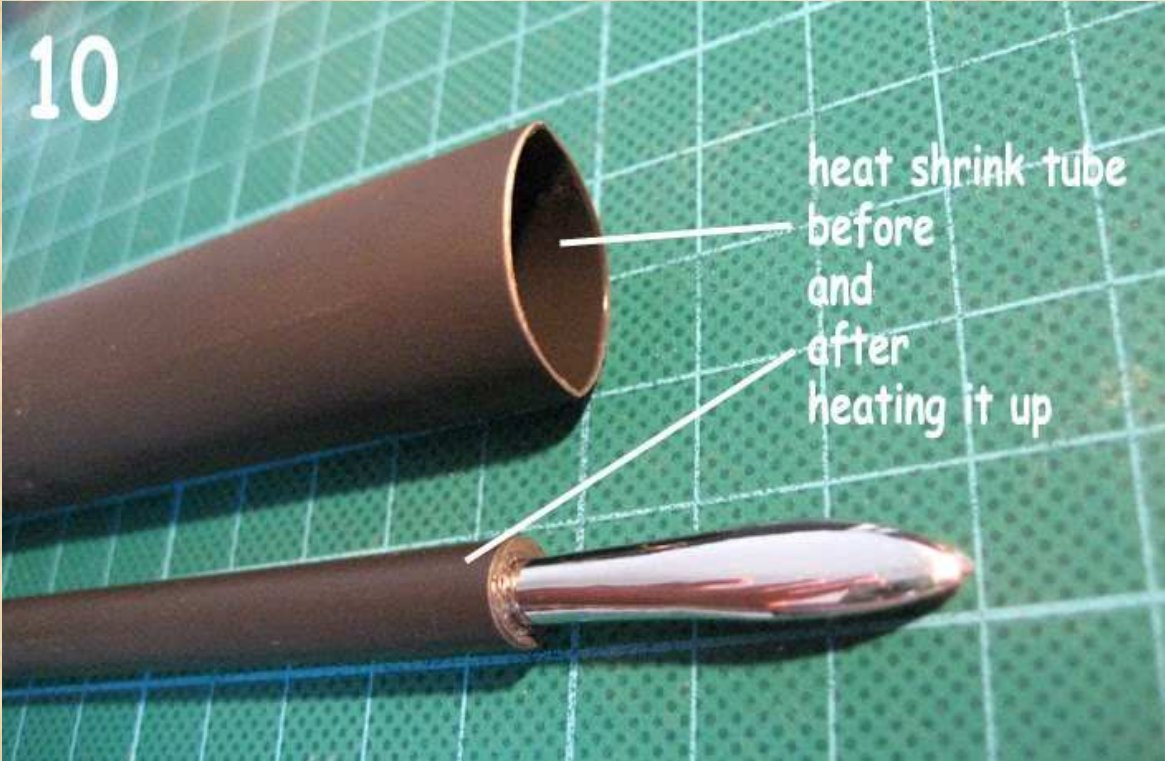

I just made two other tools in smaller sizes that way.

One is made of 4 mm steel, and one of 3.5 mm steel. For those I took heat shrink tube with the size 12/3 mm (12mm before heating / 3mm after heating).

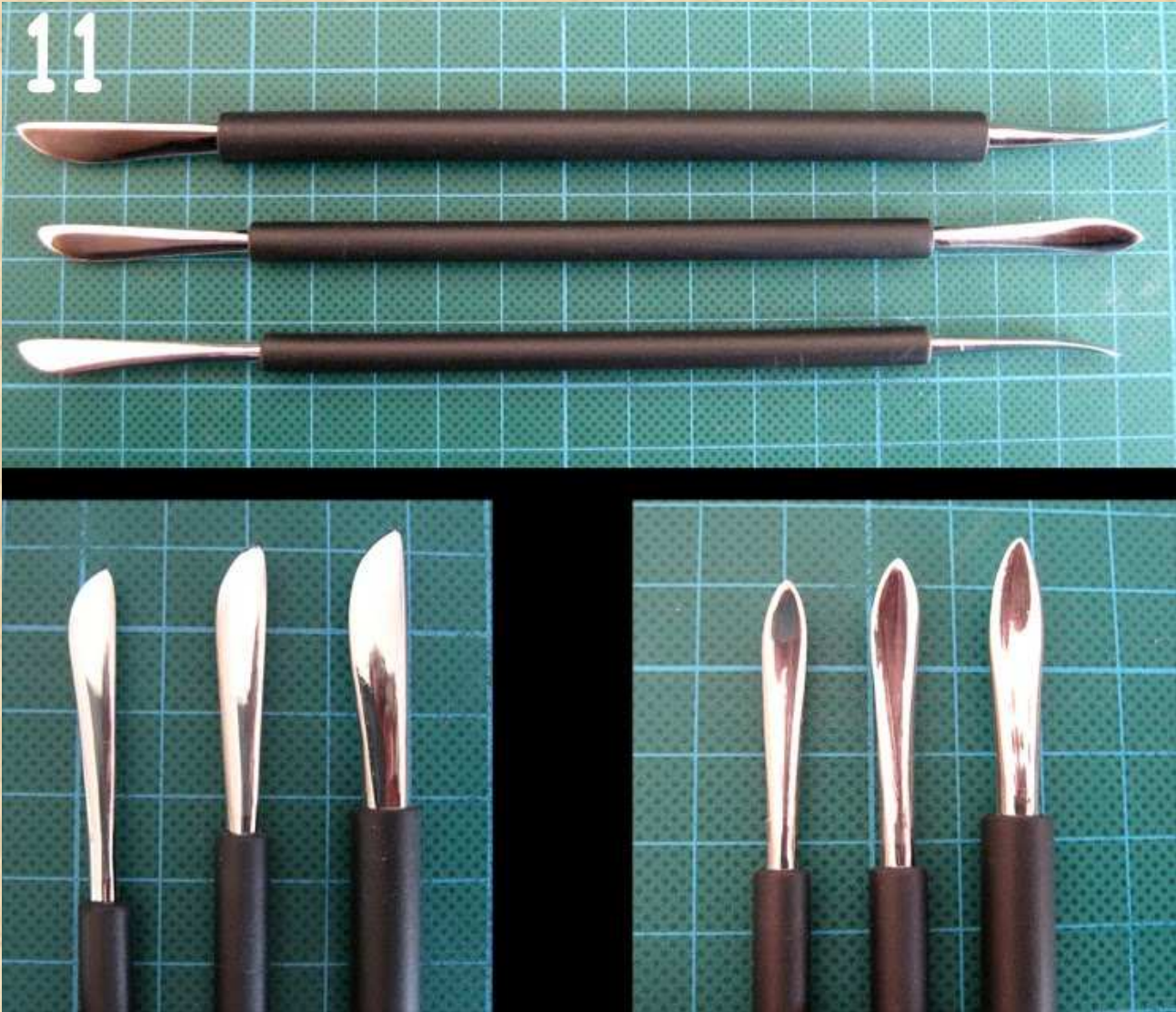

2.

For the second version I used once again an aluminium tube as a handle.

I made this handle for the smaller tool made of 4mm steel, because 4mm might be a bit too thin for the hands.

I took an aluminium tube with an outer diameter of 8mm and an inner diameter of 4 mm (Material strength = 2mm) for that.

I just cut off a piece of that tube with the desired handle-length and rounded up the ends.

Once again I've done this by fixing it into the electrical power drill and hold it slightly onto an electrical grinding stone machine like I've explained above for giving the steel rod a pointy tip.

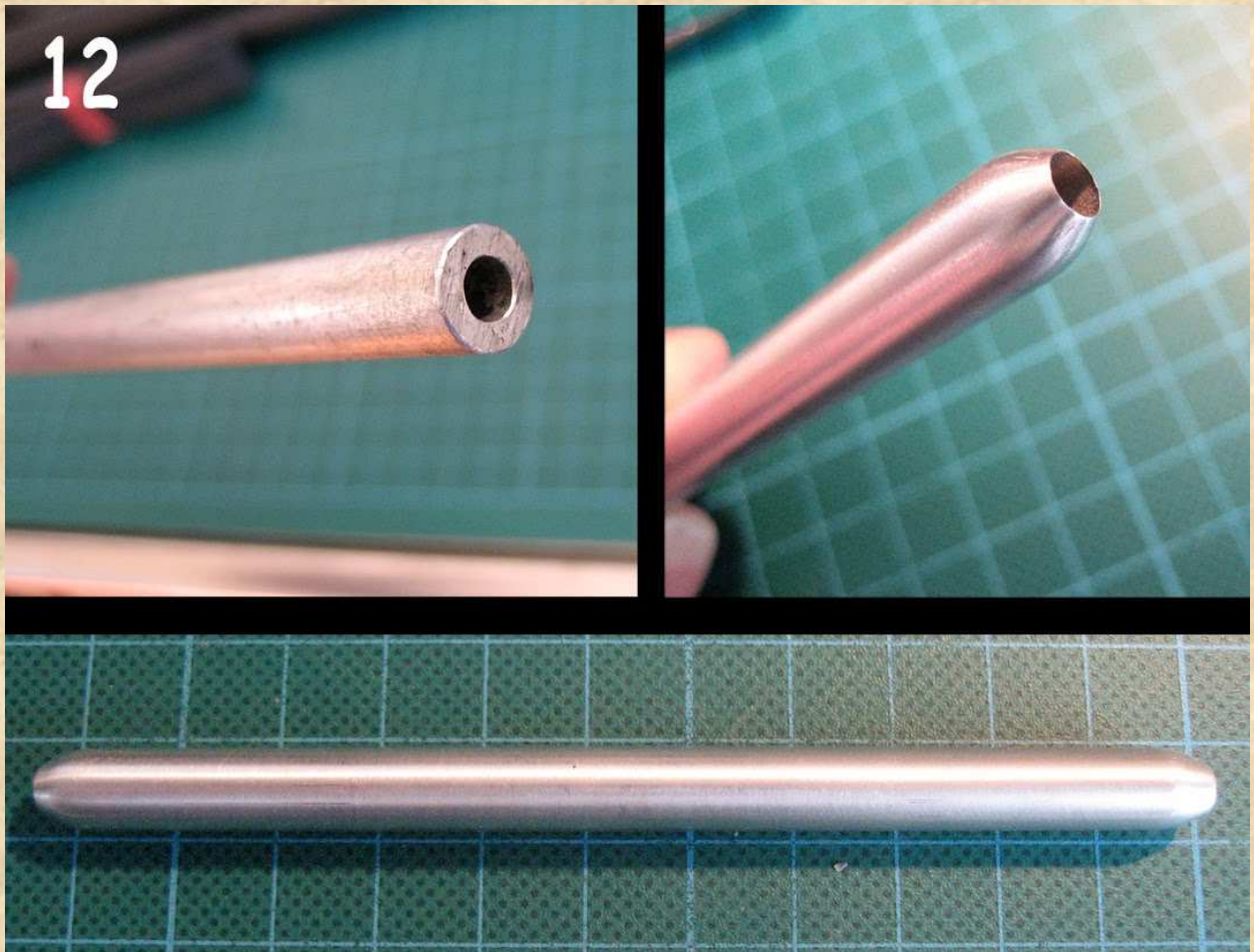



After that, I just cut the forged tool in the middle and glued each part into one end of the aluminium too with good metal glue.

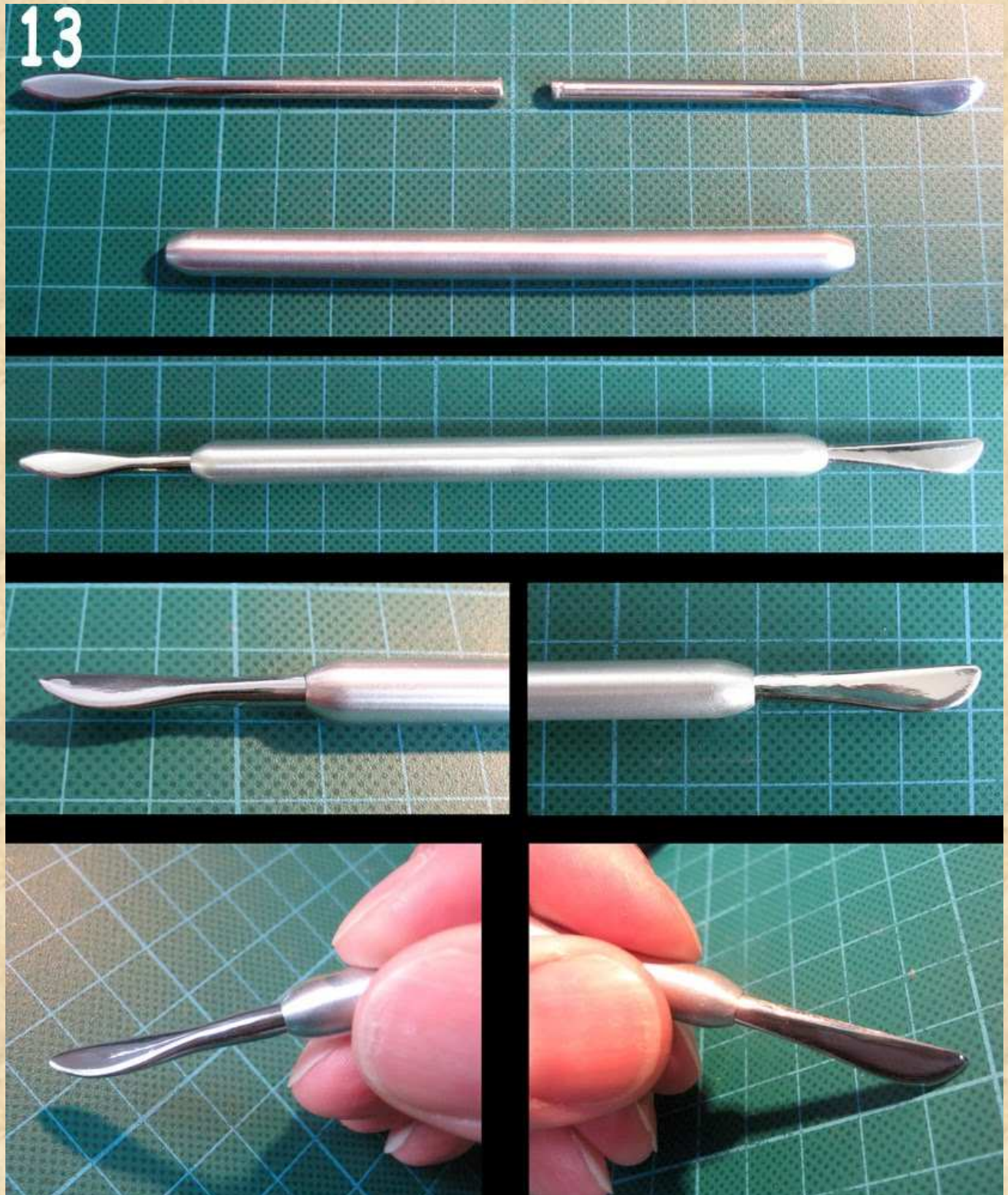

If you want to make a lighter tool, just cut off a little more of the non-forged side of each tool tip before gluing it into the aluminium handle.

You can do just the same with a 5mm diameter tool. For that you just need an aluminium tube with an outer diameter of 8 mm and an inner diameter of 5mm (material strength = 1,5mm).

If you can't find that size, you can do it with a tube combination (a tube with outer diameter = 6mm and an inner size = 5 mm inside a tube with outer diameter = 8mm and inner diameter of 6mm).

I've explained that in the post about "tool handles".

On the next picture you can see all the "larger tools" I've explained in this tutorial:



That's all about my first excursion into larger tools for sculpting.

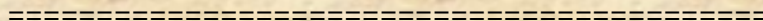

## EXPERIMENTAL TOOL: MULTI-BLADES

This time I want to share a little idea for new sculpting tools: The Multi-Blades. In fact they are more a kind of “sculpting aid” than a real tool.

The basic idea behind that is to place some hobby knife blades side by side to each other, to they will produce exactly parallel cuts.

I call them “experimental tools”, because by now, I’m not so sure about them. So if you like, just play around with them and maybe you will get some nice results. At least, I got some :-)

Here are some examples:

While sculpting miniatures, you also have to sculpt belts and other kinds of straps sometimes. For doing this, there are basically two ways:

a.

You make a separate “belt” by flattening a piece of putty, cutting out a belt of that and fix this to your miniature.

b.

You sculpt the belt right out of the miniature without adding new putty by making two parallel cuts directly on your miniature (the putty have to be fresh of course) to form the basic shape of the belt and refine this to form a real looking belt.

Usually I prefer the first method, because in my eyes the results look better most of the times. That’s because it’s not easy to get perfectly parallel cuts right on the miniature itself, so a separate cut belt looks more convincing. But sometimes, there’s the need to form the belts and straps right out of the putty that is already placed on the miniature. That’s especially the case for very small belts and straps.

So I thought about a way to ease the way to “cutting a belt right on the miniature” and I came to the idea, to get a small knife with two parallel edges. So you have to press this knife only once into the putty and you’ll get two perfectly parallel cuts simultaneously. That’s all.

To realise this idea, you just have to get some of this blades for Hobby-knives, like x-acto, Martor, Ecobra, pro edge etc. You don’t have to use new blades. In fact it is better to use and blunt blades for that, because it’s not good, if the edges are too sharp. Too sharp edges would cut too easily through the putty and form too sharp edges. If the blade is a little blunt, it will drag the putty a little down on each side of the cut when you press the blade into it. This helps to get the right shape.

I made two versions of this double-blade, a thin one and a very thin one :-).

1.

The first “very thin” version will do two cuts with a distance of less than a mm. So this is for very tiny straps or for cutting strands of hair!

You just need two hobby-knife blades. From one of this blade cut away the lower part of the blade that usually sits inside the knives handle. You can do this also by breaking the

spare part off of the blade, but be very careful while doing that. You have to use two flat nose pliers for that to hold the blade tight while breaking it. And be sure to protect your eyes while doing that.

If you have managed this, just glue the remaining part of the blade to the side of the other complete blade with good metal glue. You have to be accurate at this part to place the two edges exactly on top of each other.

On the following picture you can see the stages of creating the double blade:

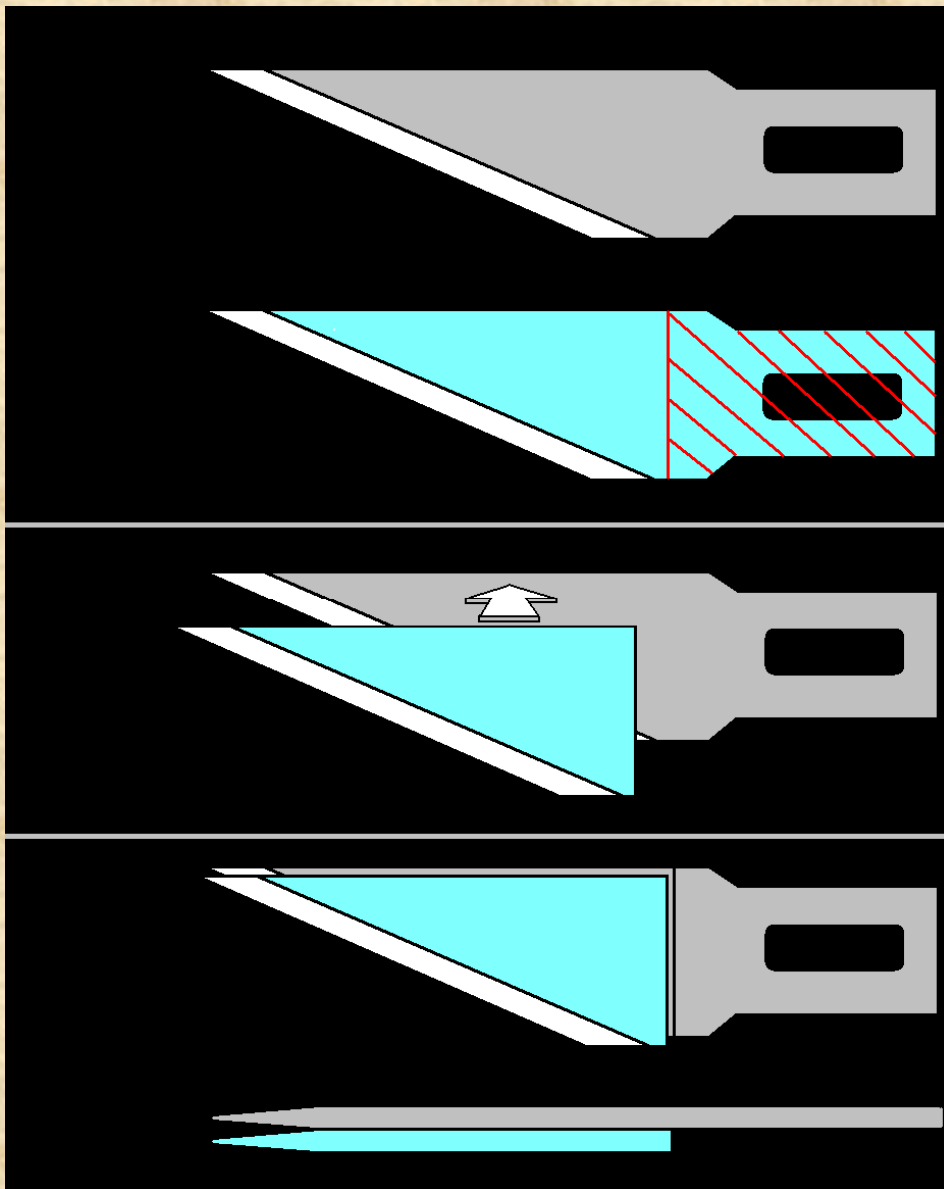

You can place the finished double blade into the handle of the hobby-knife, like any other blade. That's the reason, why you have to cut away the back part of one of the blades, because two blades wouldn't fit into the handle at the same time. At least that's the case with my hobby-knife handles. If you got a handle that can hold two parallel blades at the same time, you don't have to cut away anything, just glue two blades together and you are done.

But if you haven't got such a handle, just do it as described.

2.

Ok, the first double-blade makes quite thin belts. So I made a second version which makes a slightly broader belt/strap.

For doing this, you need three hobby-knife blades.

On two of them cut or break away the back parts just as I've described before.

On the third cut away the sharp edge over the whole length of the blade. Remove about two mm of the edge. Look at the following picture to see better what I mean.

Then just glue the cut blades on each side of the remaining full length blade, like explained before. On the next picture you can see the different stages:

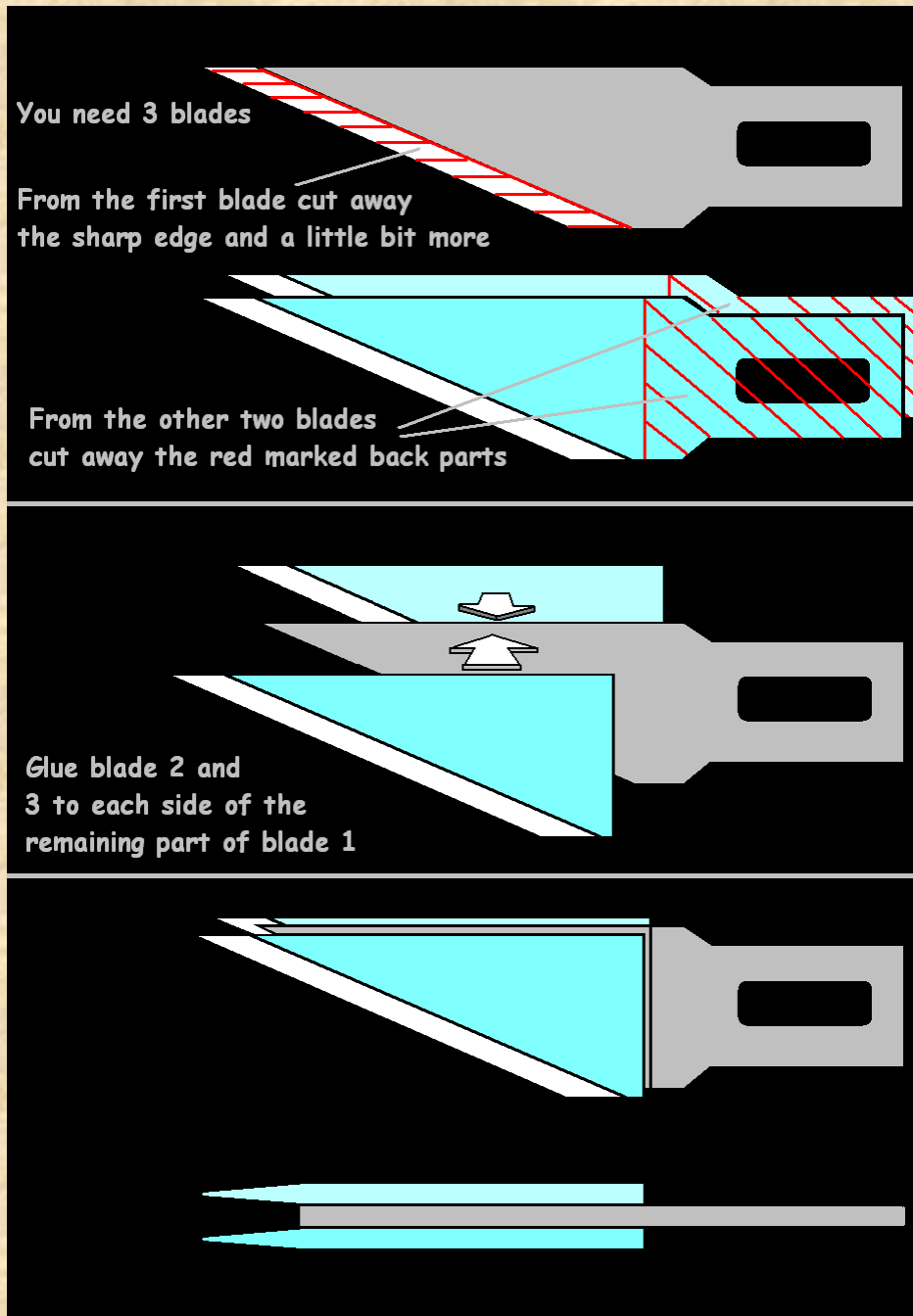

That's it. If pressed into the putty, this double blade will do belts / straps that are twice as broad as those formed by the first version of the double blade.

After doing the two "Double-Blades" that I've described before, I just do a third version, this time a "Triple-Blade".

The idea behind such a triple-blade is to use it for sculpting fur. You can make a series of small cuts into the putty (drag the blade out of the putty at the end of the cut) to make a nice fur structure.

The building process of this “Triple-Blade” is nearly the same as for the second “Double-Blade” except that you don’t have to cut away the edge on one of the hobby knife blades. The next picture shows exactly, what you have to do:

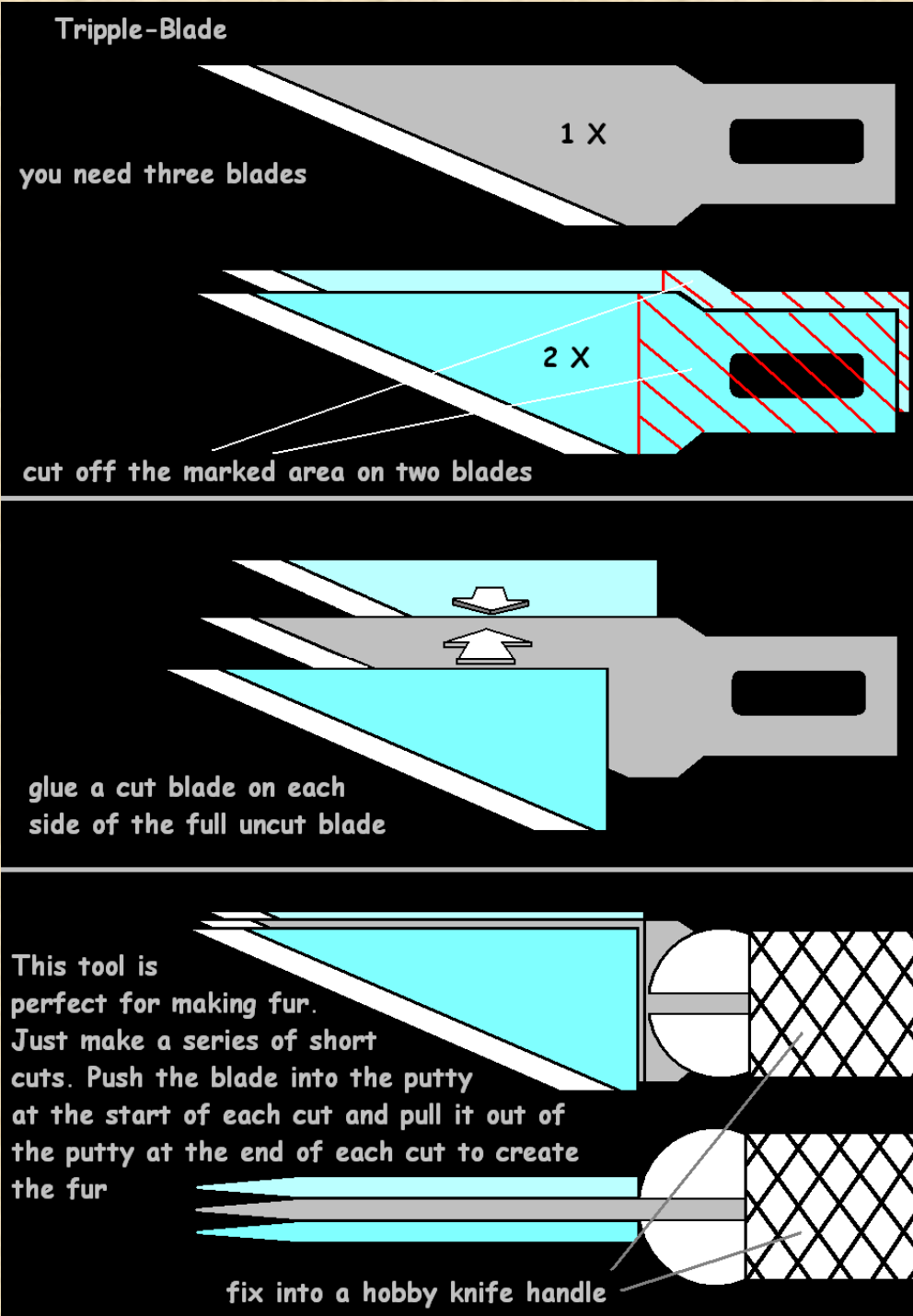

If you got the idea behind that, you can easily make other multi-blades with other distances between the edges. You just have to glue “something” between the blades to form the distance and get the whole thing on a kind of handle.

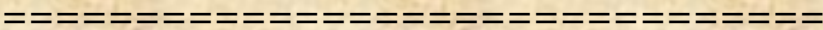

## STORING WIP MINIATURES – A SOLUTION

Here I'd like to present an idea about storing unfinished miniatures to keep them safe between the sculpting sessions.

Usually I've done my sculpting with two part epoxy putties like greenstuff and Procreate, but lately I've tried my hands more and more on polymer clays that have to be baked in the oven to get hard. Especially since the BeeSPutty produced by Stefan Niehues is out I'm doing my stuff with this polymer clay.

The biggest advantage (at least for me) of polymer clay is the fact that -unlike the epoxy putties (greenstuff/Procreate)- it won't get hard and stays workable until you bake it in the oven.

But this advantage is also a disadvantage or at least it could be. Because the clay stays soft, you have to be very careful not to ruin all your sculpting work by accidentally squashing the miniature.

Especially between the sculpting sessions, you have to be sure to store the work-in-progress miniatures in a safe place where they won't be accidentally damaged.

So this is why I came out with the idea to create such a safe storage place. The idea is just to take an empty jam jar to store the miniatures. Usually miniatures will be made with a base-armature made of wire that is placed into a cork as a kind of handle. So I just glued a magnet into the bottom of such a cork. As the cap of the jam jar is made of metal, the cork with the magnet will stick to it if you place the cork onto the upside down cap. Then you can screw the jar on top of the cap and your miniature is safe. You have to store the jar with the miniature upside down, with the cap as the bottom.



The magnet in the cork has just another advantage because it gives your cork a safe stand while sculpting, if you place it down to a metal surface and also in the oven if placed onto a baking tray while baking the polymer clay. Well, that's all. Not the most brilliant idea ever, but useful.



### **Additional thoughts:**

#### **About magnets:**

There are basically two kinds of magnets around: the ferrite magnets and those made of neodymium. On the pictures you can see them. The neodymium magnet is the small silverish one while the ferrite magnet is the larger dark greyish/brownish one. The neodymium magnets are much stronger, while smaller at the same time, so at first sight they seem to be better suited for this project.

But you have to know that neodymium magnets are much more sensible to heat than the ferrite magnets. On the label of the neodymium magnets it says, that working temperature is only up to 80° Celsius, which is below the temperature polymer clay needs to harden. I read on the web that neodymium magnets will loose a part of there magnetic drawing power if heated up above that temperature. I haven't tested this by now so I can't tell you exactly how much of their magnetic drawing power will get lost and if the magnet gets useless after a polymer baking session. So at least if you want to



use the cork with the magnet to be inside the oven while your polymer miniature is baked and you want to be sure, I recommend using ferrite magnets to glue into the cork. You can find ferrite as well as neodymium magnets quite easily on the web (eBay, Amazon etc.).



### **About corks:**

You can find all kinds of cork on the web (eBay, Amazon etc.). The size you use depends on the size of the miniature you want to sculpt. For sculpting 30 mm miniatures I like corks with a diameter of 2.4 cm and a height of 3.2 cm. The larger the cork, that larger and stronger the magnet to glue in should be.

### **Alternative to the jam jar:**

If you are not happy with the idea to use a jar made of (breakable and quite heavy) glass for this project, an alternative could be a container made from acrylic glass like you can see on the picture. I bought this on ebay and it is stuff you usually use for medicine/laboratory purposes. Usually these containers don't have a metal cap, so I glued a metal disk (also from ebay) onto the inside of the cap. I used double-sided adhesive tape for that, because the cap is made of slightly bendable plastic, so usual glue is useless here. You can also use these metal discs for the cap of the jam jar as the magnets will sit much stronger on this disc than on the metal of the cap alone. If you use these metal discs, be sure to use those made of metal that will be attracted by a magnet. That's usually not the case with high-grade steel.



