

Engineer's Mini-Notebook

555 Timer
IC Circuits

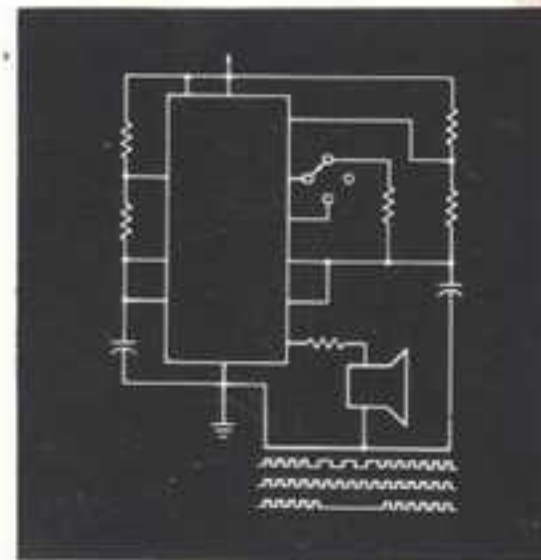
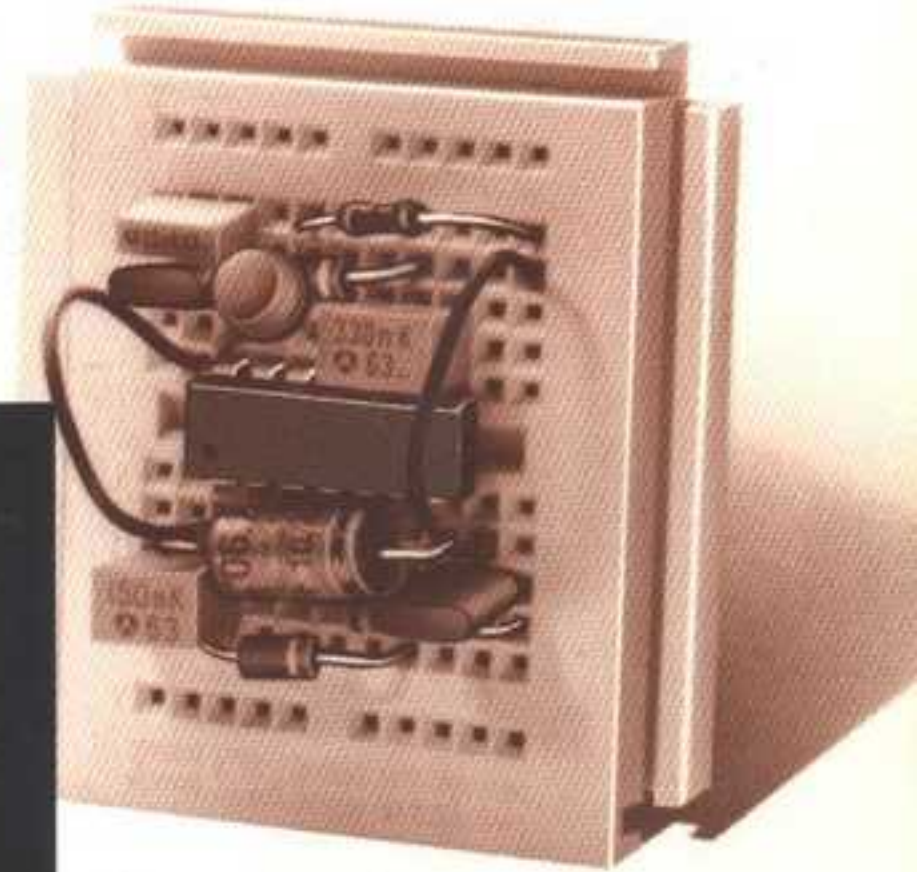

Forrest M. Mims III

Radio Shack

A Division of Tandy Corporation
Fort Worth, TX 76102

PRINTED IN U.S.A.



555/556 PIN OUTLINES

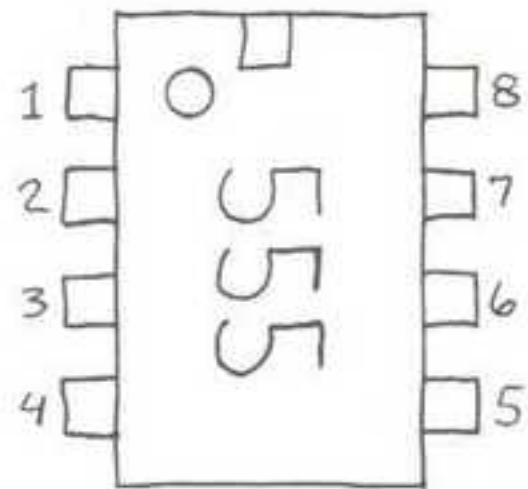

THE 556 CONTAINS TWO 555 TIMERS.

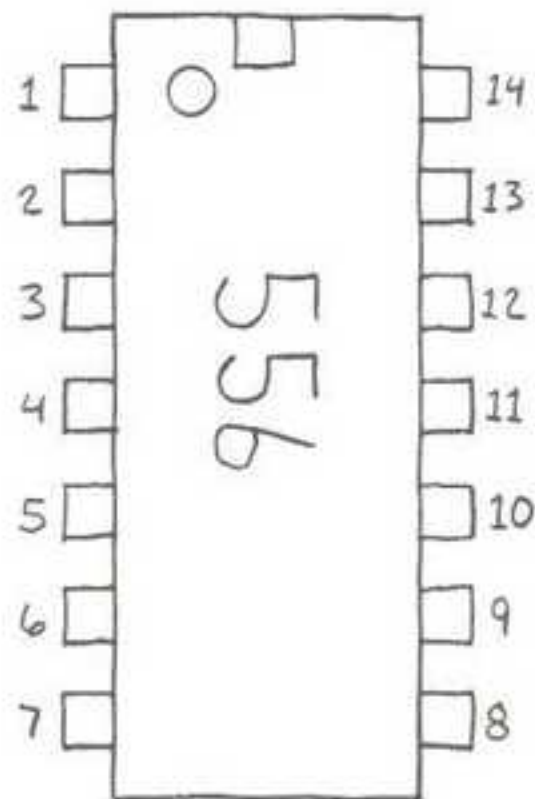

FUNCTION	555	556 (1)	556 (2)
GROUND	1	7	7
TRIGGER	2	6	8
OUTPUT	3	5	9
RESET	4	4	10
CONTROL V	5	3	11
THRESHOLD	6	2	12
DISCHARGE	7	1	13
V _{cc}	8	14	14

555 SPECIFICATIONS¹

SUPPLY VOLTAGE (V _{cc})	4.5 TO 15 V
SUPPLY CURRENT (V _{cc} = +5V)	3 TO 6 mA
SUPPLY CURRENT (V _{cc} = +15V)	10 TO 15 mA
OUTPUT CURRENT (MAXIMUM)	200 mA
POWER DISSIPATION	600 mW
OPERATING TEMPERATURE	0 TO 70° C

¹ VALUES SHOWN APPLY TO NE555.

ENGINEER'S MINI-NOTEBOOK

555 CIRCUITS

BY

FORREST M. MIMS, III

THIRD EDITION
FIRST PRINTING - 1992
SECOND PRINTING - 1993
THIRD PRINTING - 1994
FOURTH PRINTING - 1996

A SILICONCONCEPTS™ BOOK

COPYRIGHT © 1984 BY FORREST M. MIMS, III
ALL RIGHTS RESERVED

PRINTED IN THE UNITED STATES OF AMERICA

PLEASE READ THIS FIRST...

THIS BOOK IS FOR THE ENTERTAINMENT AND EDIFICATION OF ITS READERS. WHILE REASONABLE CARE HAS BEEN EXERCISED WITH RESPECT TO ITS ACCURACY, THE AUTHOR AND RADIO SHACK ASSUME NO RESPONSIBILITY FOR ERRORS, OMISSIONS OR SUITABILITY OF ITS CONTENTS FOR ANY APPLICATION. NOR DO WE ASSUME ANY LIABILITY FOR ANY DAMAGES RESULTING FROM USE OF INFORMATION IN THIS BOOK. IT IS YOUR RESPONSIBILITY TO DETERMINE IF USE, SALE OR MANUFACTURE OF ANY DEVICE THAT INCORPORATES INFORMATION IN THIS BOOK INFRINGES ANY PATENTS, COPYRIGHTS OR OTHER RIGHTS.

DUE TO THE MANY CUSTOMER INQUIRIES RECEIVED BY RADIO SHACK AND THE AUTHOR, IT IS IMPOSSIBLE TO ANSWER REQUESTS FOR ADDITIONAL INFORMATION (CUSTOM CIRCUIT DESIGNS, TECHNICAL ADVICE, TROUBLESHOOTING ADVICE, ETC.). BUT THOUGH WE CANNOT ACKNOWLEDGE INDIVIDUAL INQUIRIES, WE WILL BE HAPPY TO RECEIVE ANY COMMENTS, IMPRESSIONS, SUGGESTIONS AND INFORMATION ABOUT SUSPECTED ERRORS IN THIS BOOK.

THANKS IN ADVANCE TO THOSE OF YOU WHO WRITE! BUT PLEASE REMEMBER WE WILL BE UNABLE TO RESPOND PERSONALLY.

CONTENTS

INTRODUCTION	4
CIRCUIT ASSEMBLY TIPS	4
555 SPECIFICATIONS	5
555 BLOCK DIAGRAM	5
CIRCUITS	
BASIC MONOSTABLE	6
BASIC ASTABLE	7
BOUNCEFREE SWITCH	8
TOUCH ACTIVATED SWITCH	8
TIMER PLUS RELAY	9
CASCADED TIMER	10
INTERVALOMETER	11
MISSING PULSE DETECTOR	12
EVENT FAILURE ALARM	13
FREQUENCY DIVIDER	14
VOLTAGE-CONTROLLED OSCILLATOR	15
PULSE GENERATOR	16
FREQUENCY METER	17
AUDIO OSCILLATOR/METRONOME	18
TOY ORGAN	19
GATED OSCILLATOR	20
CHIRP GENERATOR	21
STEPPED-TONE GENERATOR	22
3-STATE TONE GENERATOR	23
TONE BURST GENERATOR	24
SOUND EFFECTS GENERATOR	25
LED FLASHER	26
POWER FET LAMP DIMMER	27
LIGHT/DARK DETECTOR	28
INFRARED SECURITY ALARM	29
ANALOG LIGHTWAVE TRANSMITTER	30
ANALOG LIGHTWAVE RECEIVER	31
DC-DC CONVERTER	32

INTRODUCTION

THE 555 TIMER IS ONE OF THE MOST POPULAR AND VERSATILE INTEGRATED CIRCUITS EVER PRODUCED. IT INCLUDES 23 TRANSISTORS, 2 DIODES AND 16 RESISTORS ON A SILICON CHIP INSTALLED IN AN 8-PIN MINI DUAL-IN-LINE PACKAGE (DIP). THE 556 IS A 14-PIN DIP THAT COMBINES TWO 555'S ON A SINGLE CHIP. ALSO AVAILABLE ARE ULTRA-LOW POWER VERSIONS OF THE 555. THE 555 HAS TWO PRINCIPLE OPERATING MODES:

MONOSTABLE MODE - IN THIS MODE THE 555 FUNCTIONS AS A "ONE-SHOT." APPLICATIONS INCLUDE TIMERS, MISSING PULSE DETECTION, BOUNCEFREE SWITCHES, TOUCH SWITCHES, ETC.

ASTABLE MODE - THE 555 CAN OPERATE AS AN OSCILLATOR. USES INCLUDE LED AND LAMP FLASHERS, PULSE GENERATION, LOGIC CLOCKS, TONE GENERATION, SECURITY ALARMS, ETC.

CIRCUIT ASSEMBLY TIPS

BUILD TEST VERSIONS OF CIRCUITS ON PLASTIC SOLDERLESS BREADBOARD BEFORE MAKING THEM PERMANENT. IN MONOSTABLE CIRCUITS WHERE FALSE TRIGGERING MIGHT CAUSE PROBLEMS, TIE PIN 5 TO GROUND VIA A $0.1 \mu\text{F}$ CAPACITOR. IF POWER LEADS ARE LONG OR IF A CIRCUIT SEEMS TO MALFUNCTION, PLACE A $0.1 \mu\text{F}$ CAPACITOR ACROSS PINS 8 AND 1. A $1 \mu\text{F}$ CAPACITOR MAY ALSO BE NECESSARY. BE SURE TO EXPERIMENT WITH VALUES OF TIMING RESISTORS AND CAPACITORS. THE BASIC CIRCUITS ON PP. 6-7 EXPLAIN THE ROLE THESE COMPONENTS PLAY. REMEMBER THAT THE 556 REPLACES TWO 555'S. LOW-POWER VERSIONS OF THE 555 MAY REQUIRE SOME REVISIONS TO STANDARD 555 CIRCUITS. FOR MORE TIPS, SEE THE RADIO SHACK BOOK "GETTING STARTED IN ELECTRONICS."

555 SPECIFICATIONS¹

SUPPLY VOLTAGE (V_{cc})	4.5 TO 15 V
SUPPLY CURRENT ($V_{cc}=+5V$) ²	3 TO 6 mA
SUPPLY CURRENT ($V_{cc}=+15V$) ²	10 TO 15 mA
OUTPUT CURRENT	200 mA (MAXIMUM)
POWER DISSIPATION	600 mW
OPERATING TEMPERATURE	0 TO 70° C

1 VALUES SHOWN APPLY TO NE555 (8 PIN MINI-DIP).

2 OUTPUT CURRENT = 0.

INTERNAL BLOCK DIAGRAM

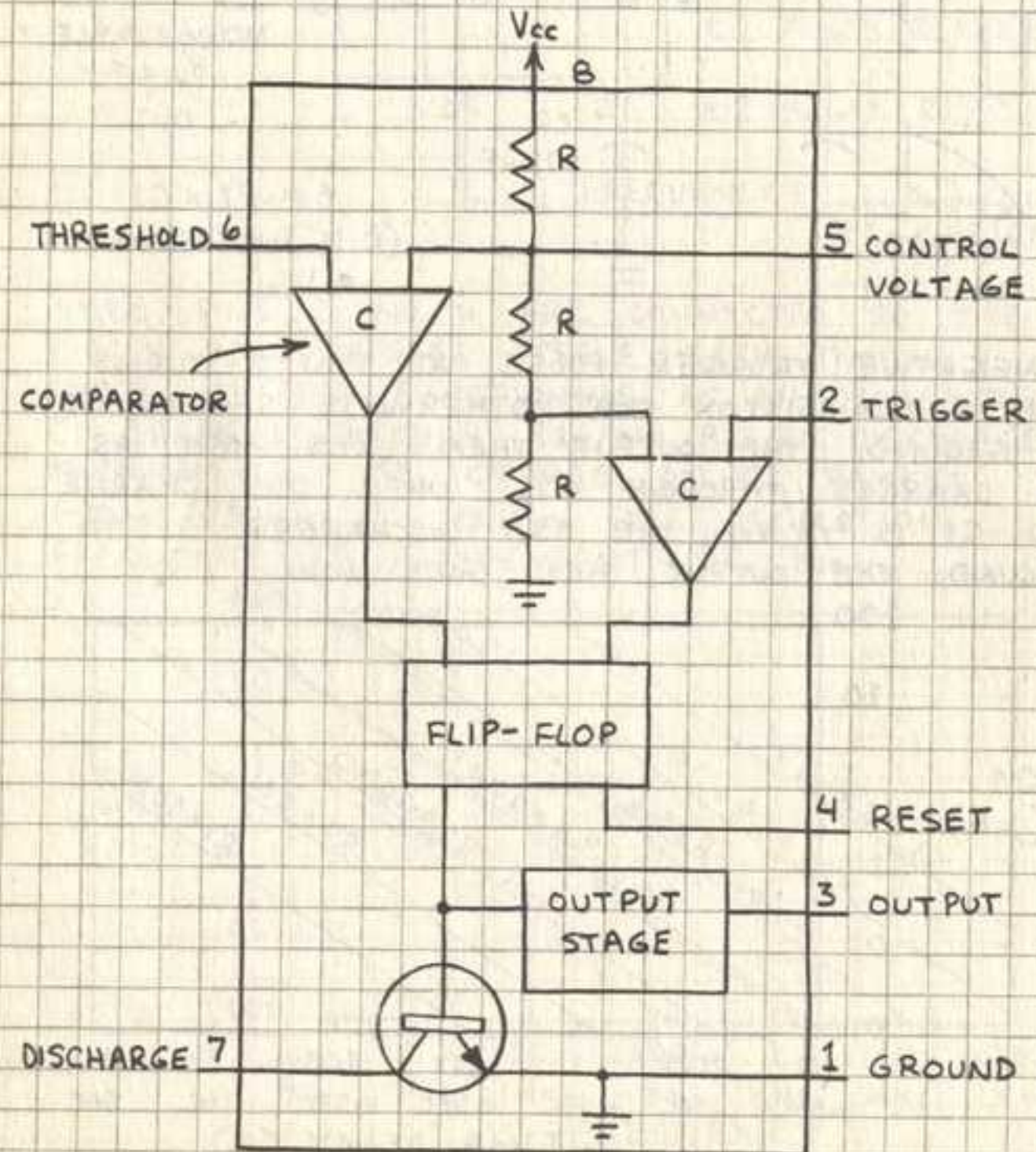

BASIC MONOSTABLE CIRCUIT

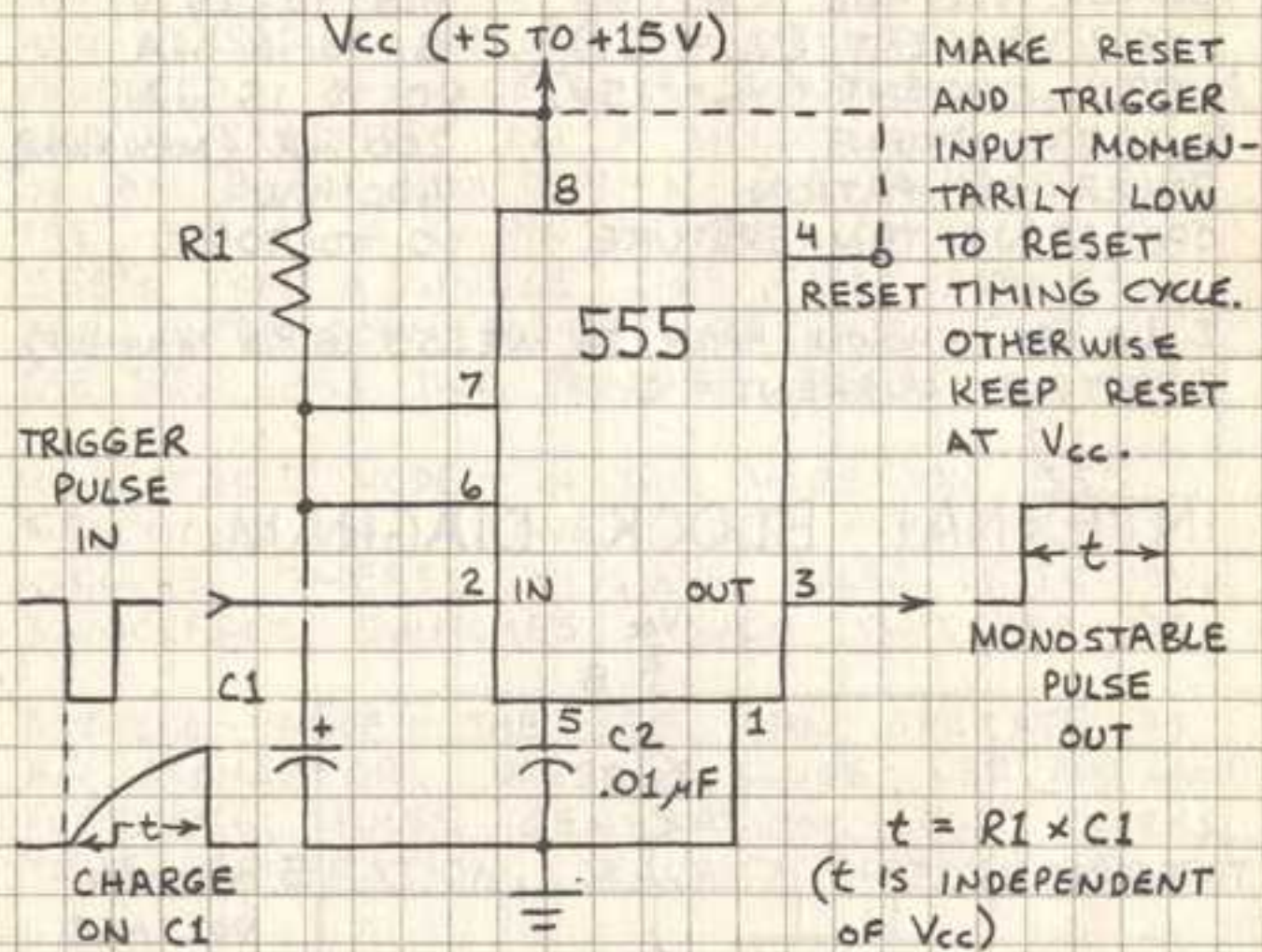

A NEGATIVE TRIGGER PULSE AT PIN 2 TURNS OFF A TRANSISTOR THAT OTHERWISE SHORTS C1 TO GROUND. THE OUTPUT THEN GOES HIGH AS C1 CHARGES THROUGH R1. WHEN THE CHARGE ON C1 IS $\frac{2}{3} V_{cc}$, THE 555 DISCHARGES C1 TO GROUND. THE OUTPUT THEN GOES LOW.

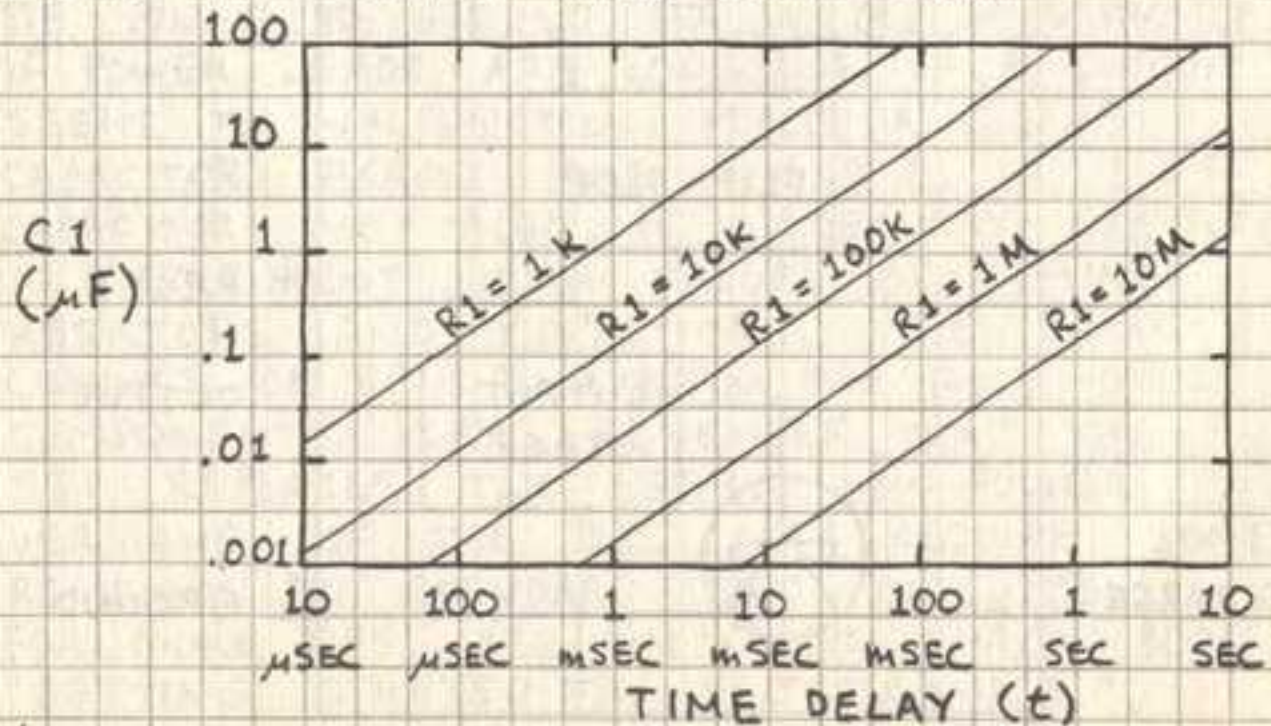

BASIC ASTABLE CIRCUIT

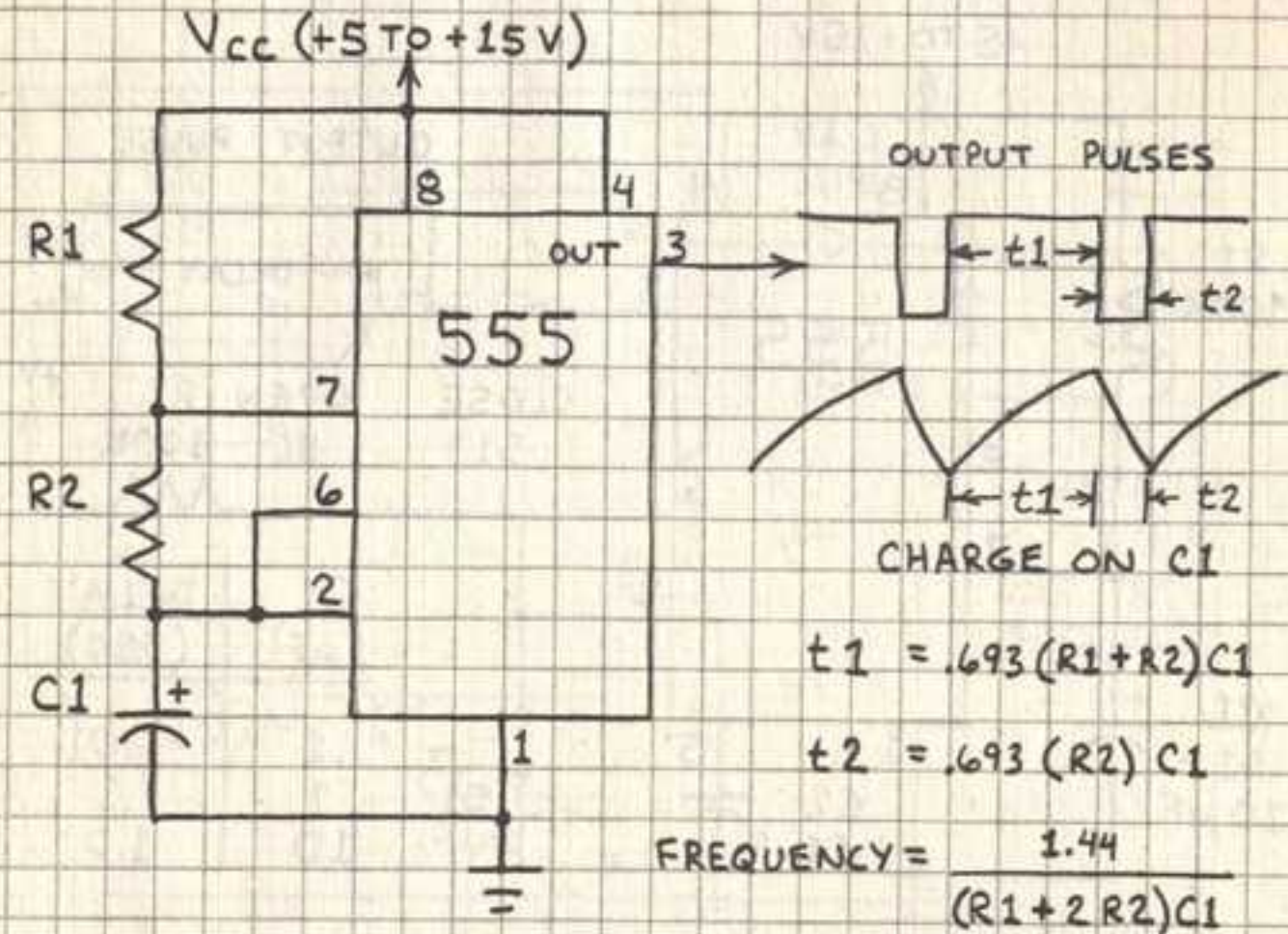

HERE PINS 2 AND 6 ARE CONNECTED SO THE CIRCUIT WILL TRIGGER ITSELF EACH TIMING CYCLE, THEREBY FUNCTIONING AS AN OSCILLATOR. C1 CHARGES THROUGH R1 AND R2 BUT DISCHARGES THROUGH R2. THE CHARGE ON C1 RANGES FROM $\frac{1}{3} V_{cc}$ TO $\frac{2}{3} V_{cc}$. THE OSCILLATION FREQUENCY IS INDEPENDENT OF V_{cc} .

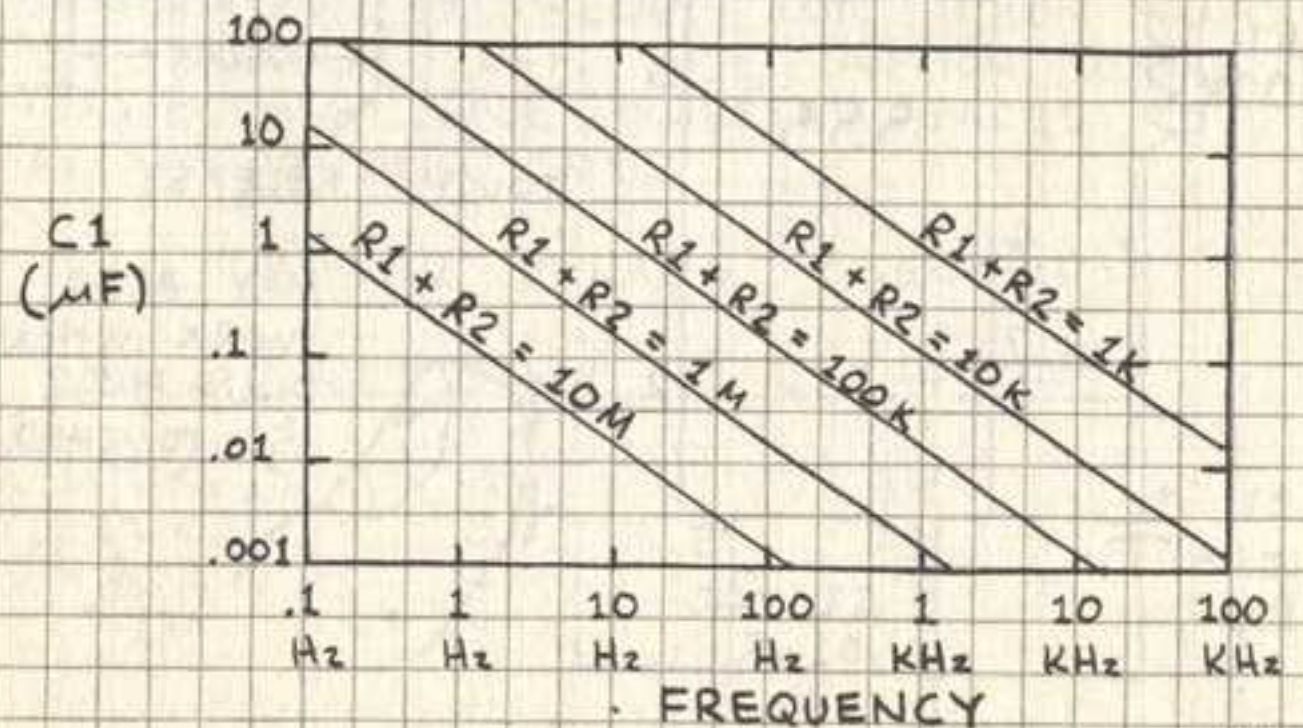

BOUNCEFREE SWITCH

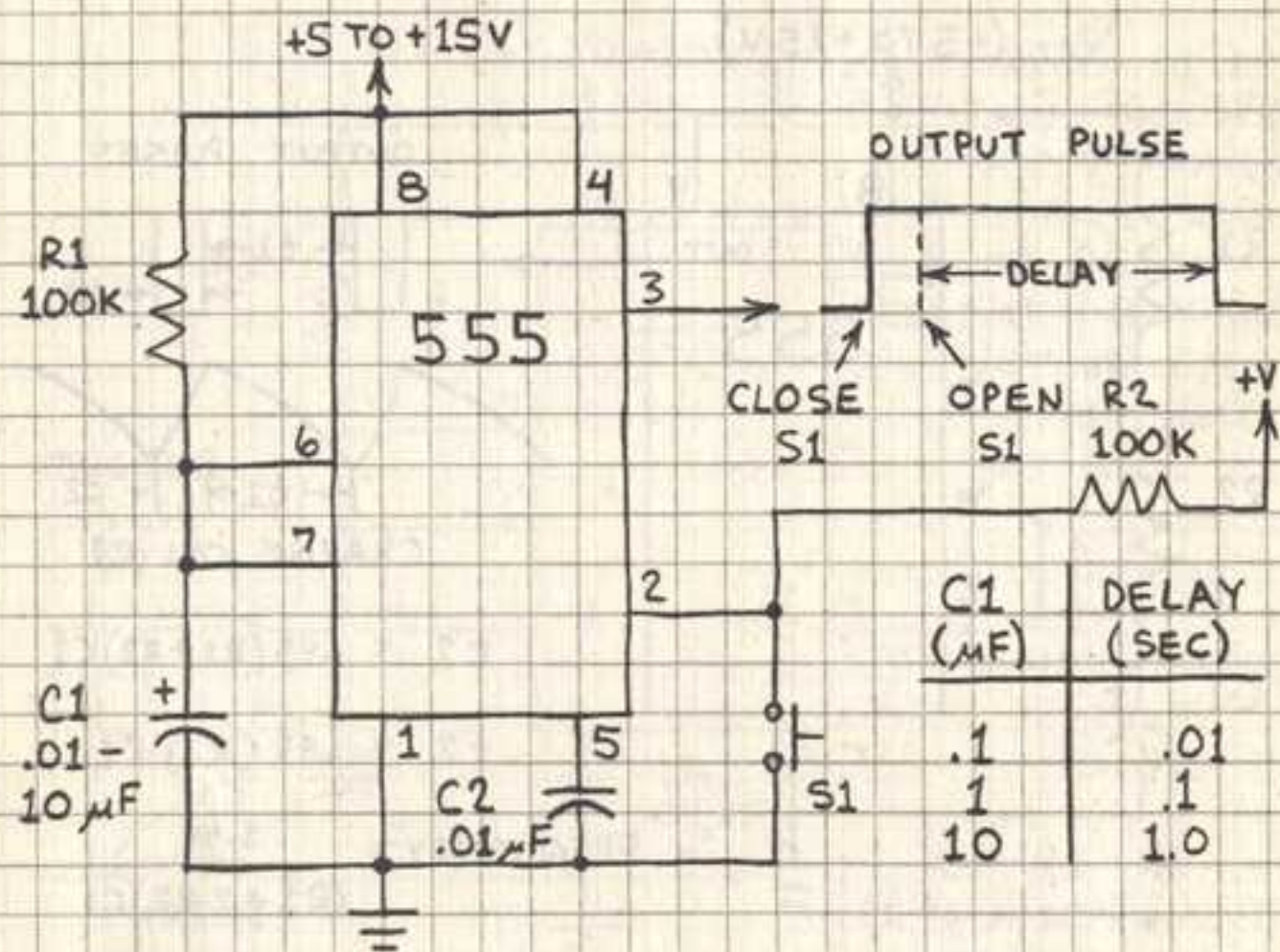

TOUCH-ACTIVATED SWITCH

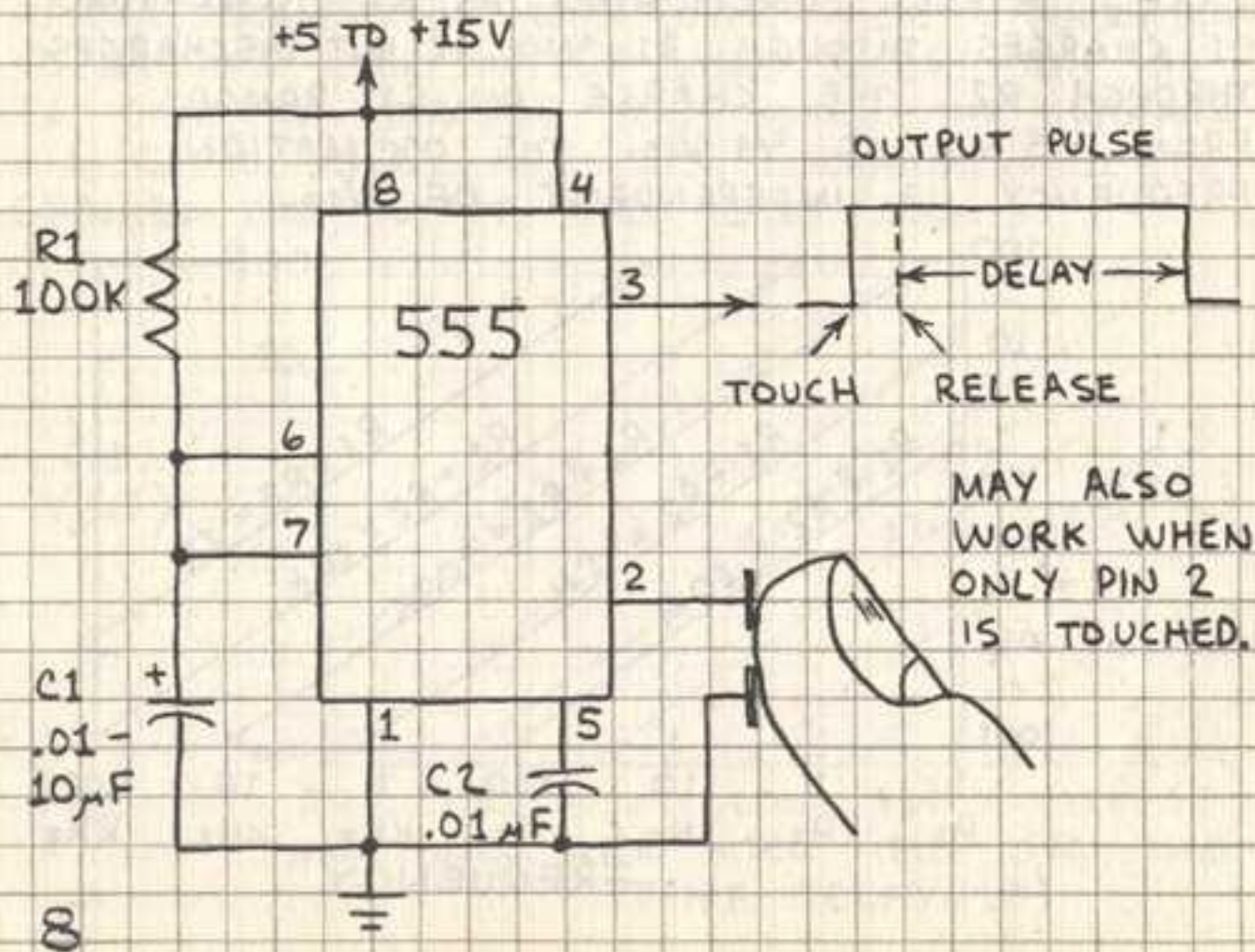

TIMER PLUS RELAY

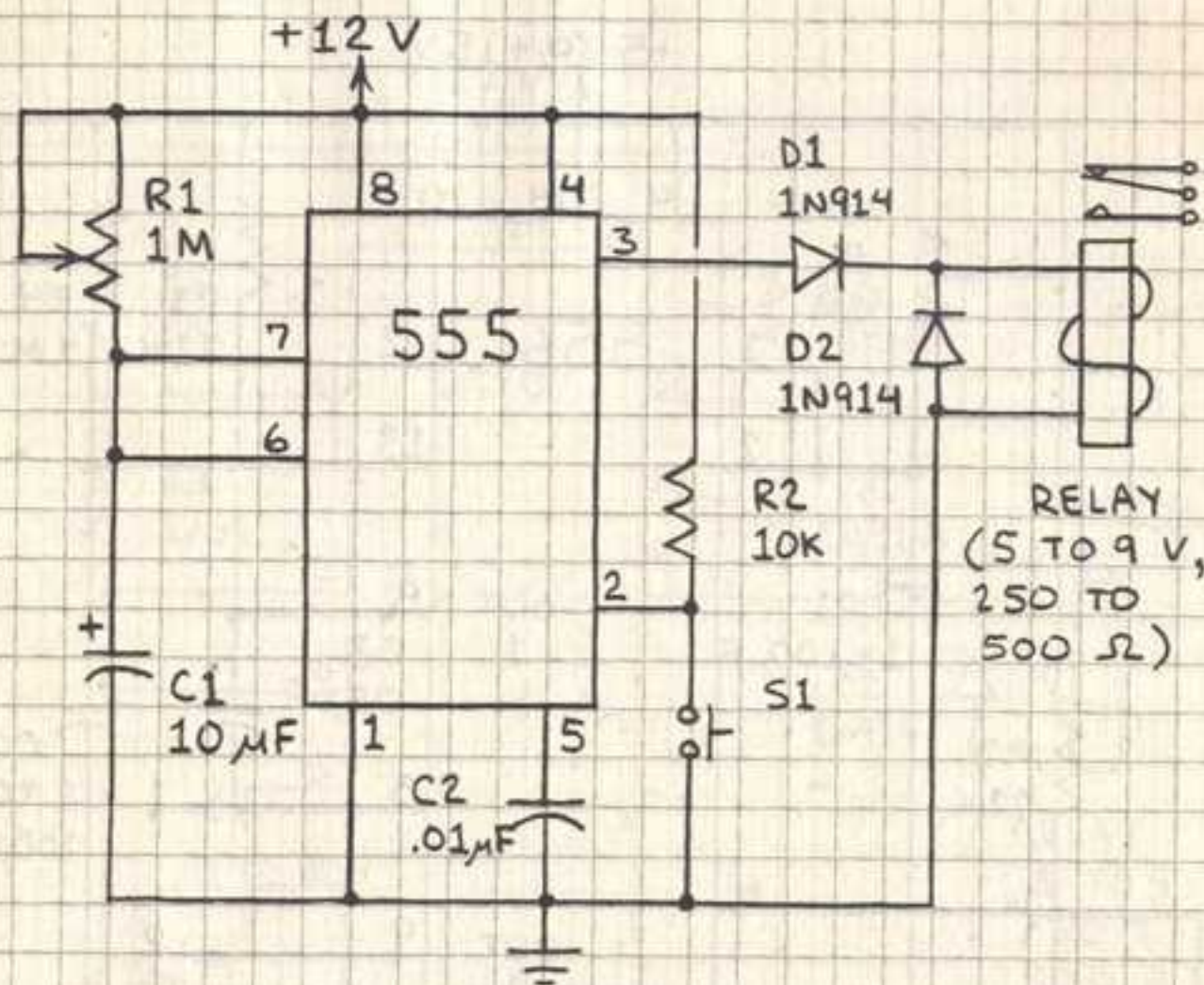

CLOSING S1 MOMENTARILY BEGINS A TIMING CYCLE. THE RELAY IS ACTUATED DURING THE ENTIRE CYCLE. R1 AND C1 CONTROL TIME DELAY. C2 PREVENTS FALSE TRIGGERING. D2 ABSORBS VOLTAGE GENERATED BY RELAY COIL WHEN RELAY IS SWITCHED OFF. USE CAUTION WHEN CONNECTING LINE-POWERED DEVICES TO RELAY CONNECTIONS.

TYPICAL DELAYS (SECONDS)

R1	C1 = 10µF	C1 = 100µF
100K	2	16
220K	3	33
470K	6	70
1M	15	175

CASCADED TIMER

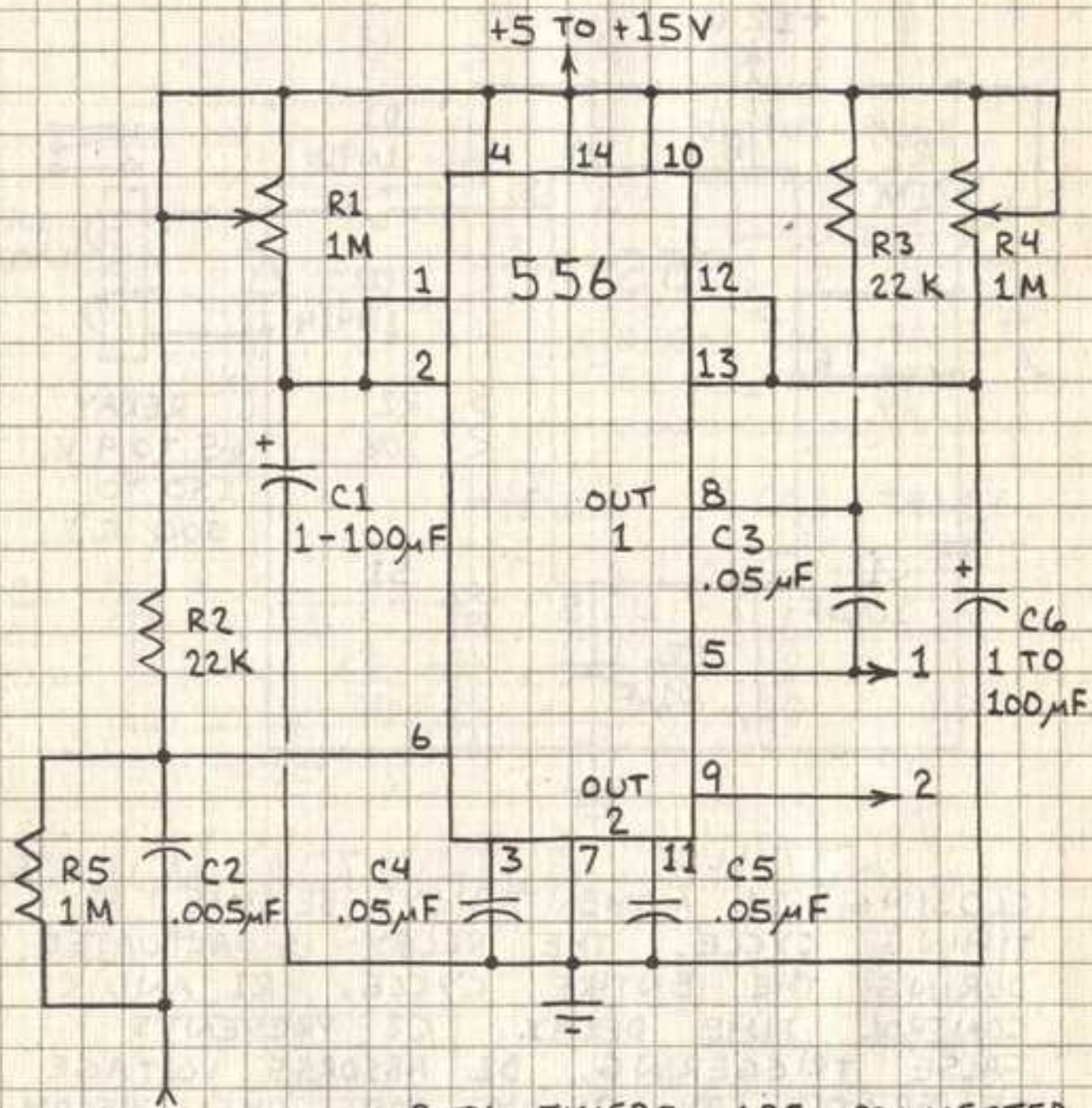

TRIGGER IN

BOTH TIMERS ARE CONNECTED IN THEIR ONE-SHOT MODE. GROUNDING THE TRIGGER INPUT STARTS TIMER 1 WHICH THEN STARTS TIMER 2.

TRIGGER

OUT 1

OUT 2

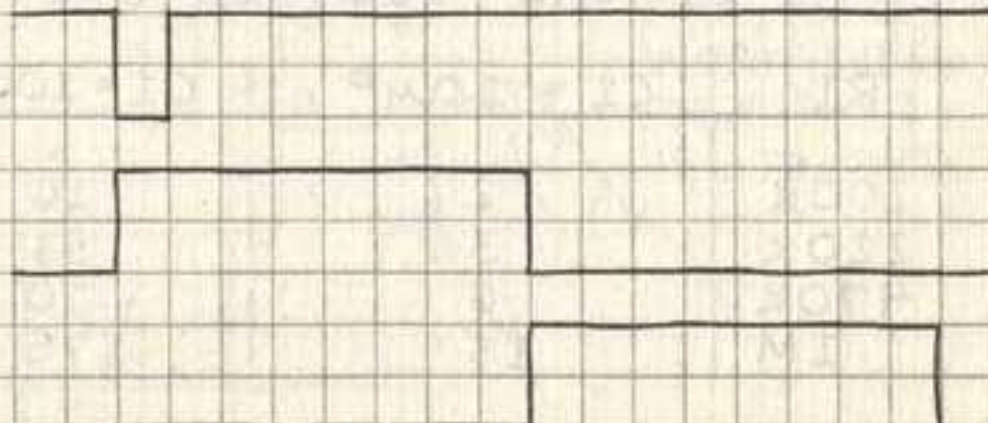

INTERVALOMETER

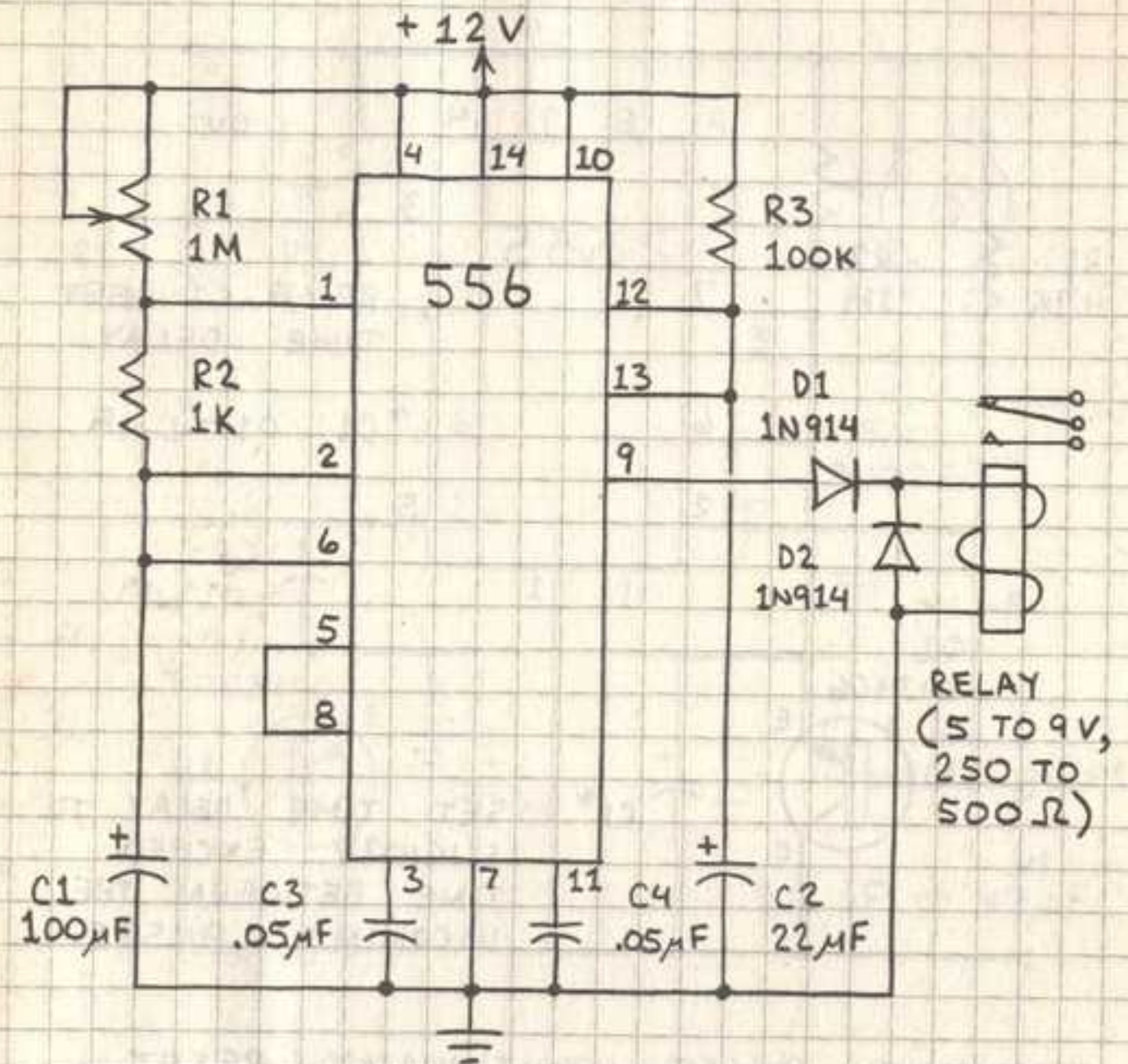

TIMER 1 IS CONNECTED AS ASTABLE OSCILLATOR WHICH OSCILLATES AT A FREQUENCY DETERMINED BY R1 AND C1. TIMER 2 IS A ONE-SHOT THAT DRIVES A RELAY VIA D1. TIMER 1 TRIGGERS TIMER 2 ONCE PER CYCLE FOR 3 TO 5 SECONDS.

TIMER 1 (PIN 5)

TIMER 2 (RELAY)

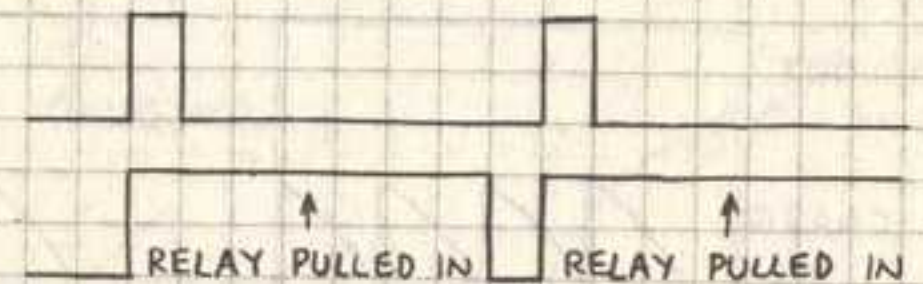

MISSING PULSE DETECTOR

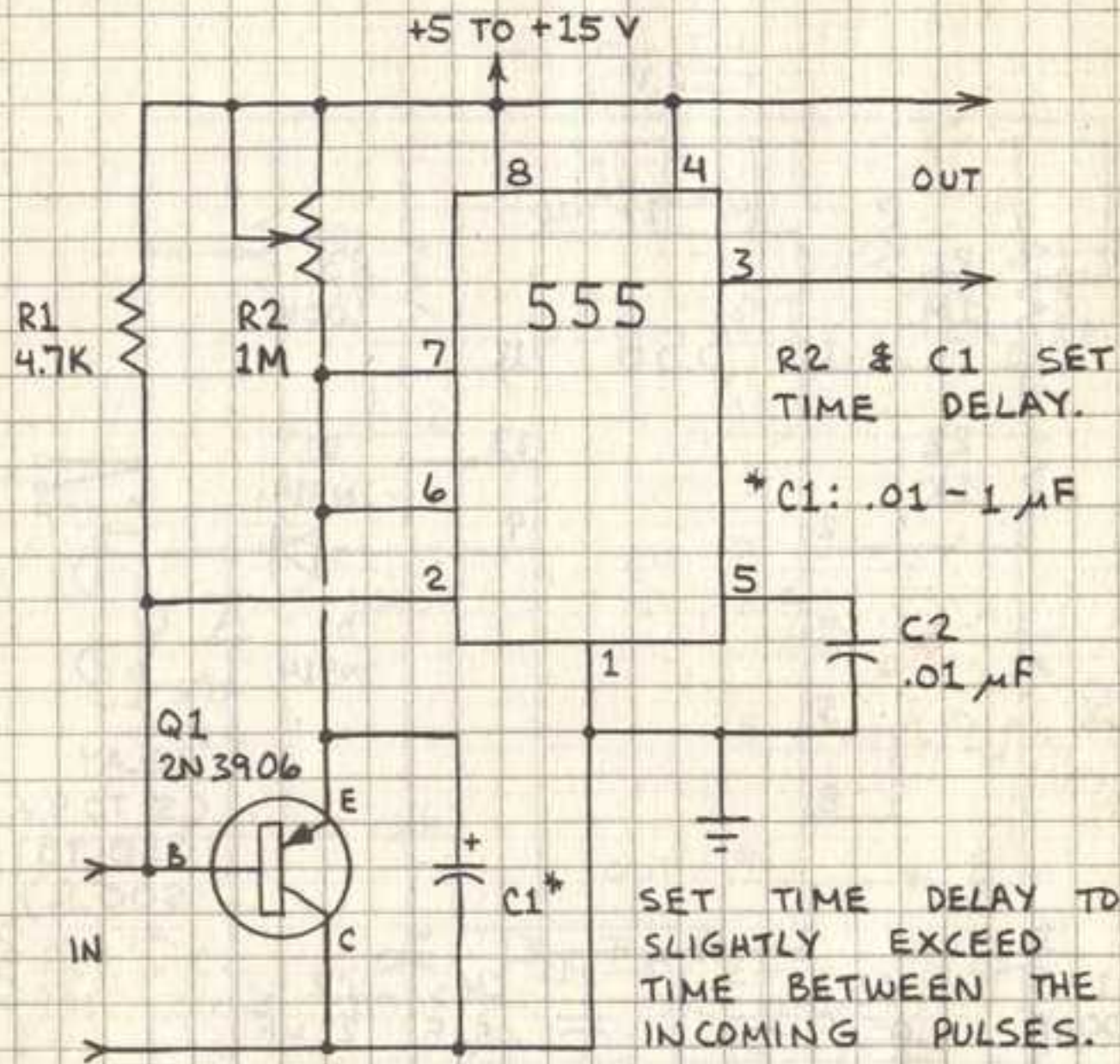

INCOMING PULSES CONTINUALLY RESET THE TIMING CYCLE. A MISSING PULSE ALLOWS THE TIMING CYCLE TO BE COMPLETED, CHANGING THE OUTPUT STATE.

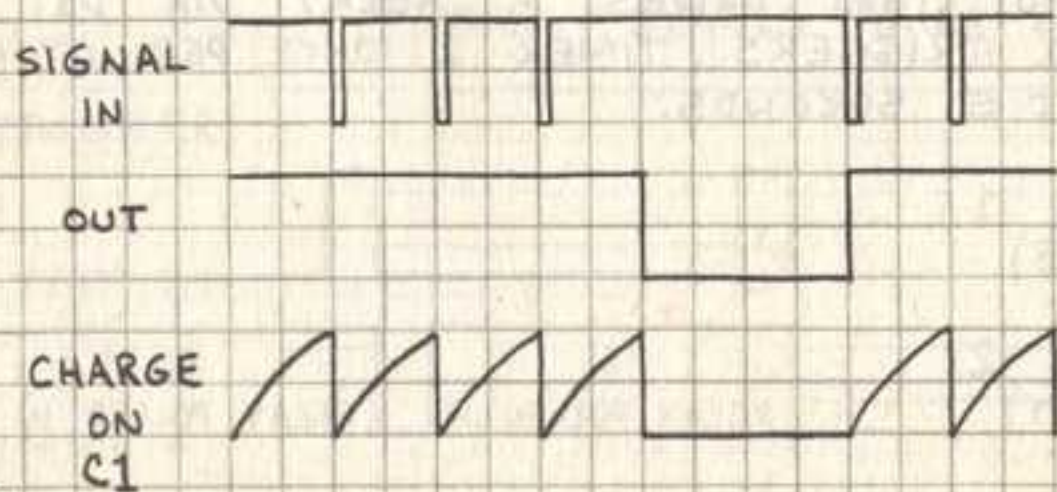

EVENT FAILURE ALARM

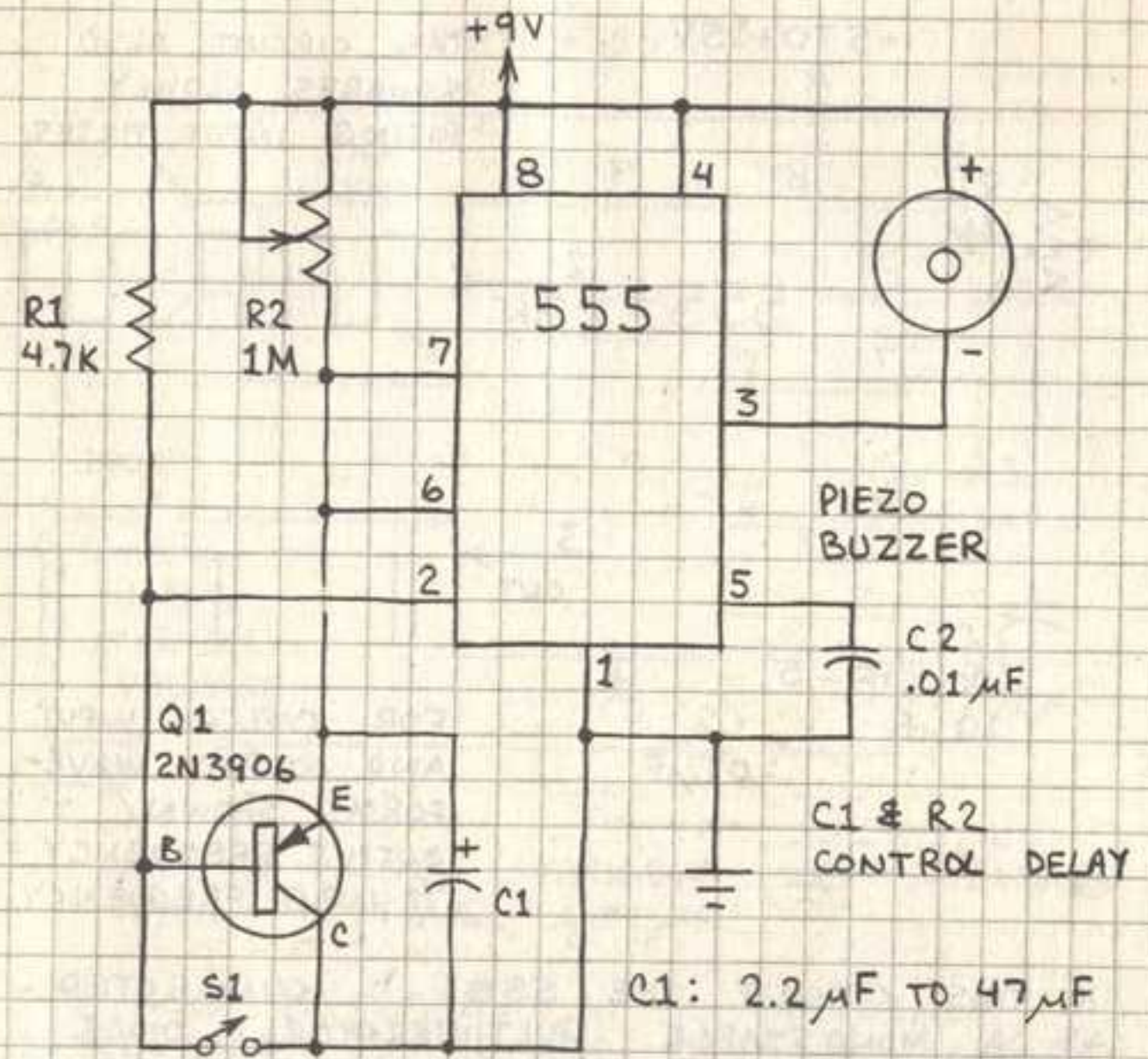

WHEN POWER IS APPLIED, C1 BEGINS TO CHARGE THROUGH R2. UNLESS S1 IS CLOSED BEFORE THE 555 TIMING CYCLE IS COMPLETED, THE BUZZER WILL SOUND. S1 CAN BE ANY EXTERNAL SWITCH.

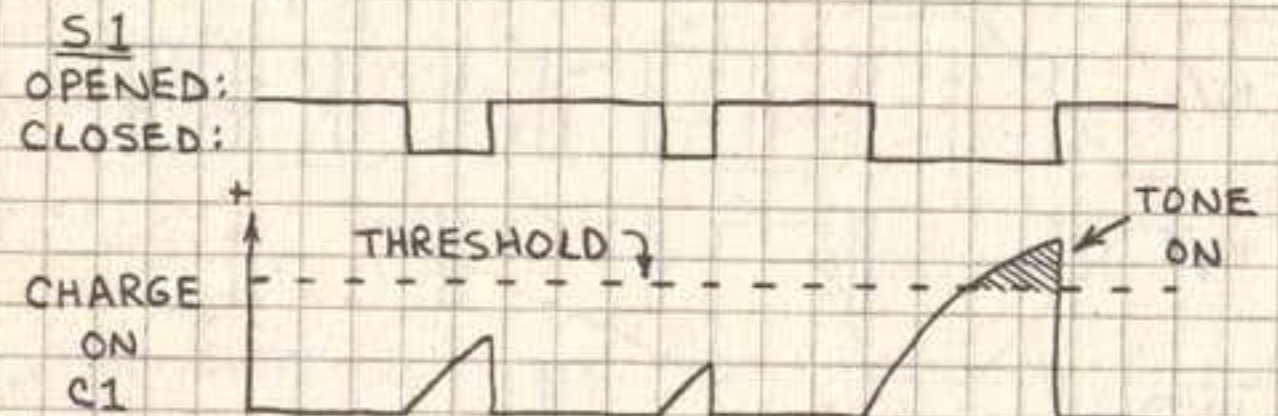

FREQUENCY DIVIDER

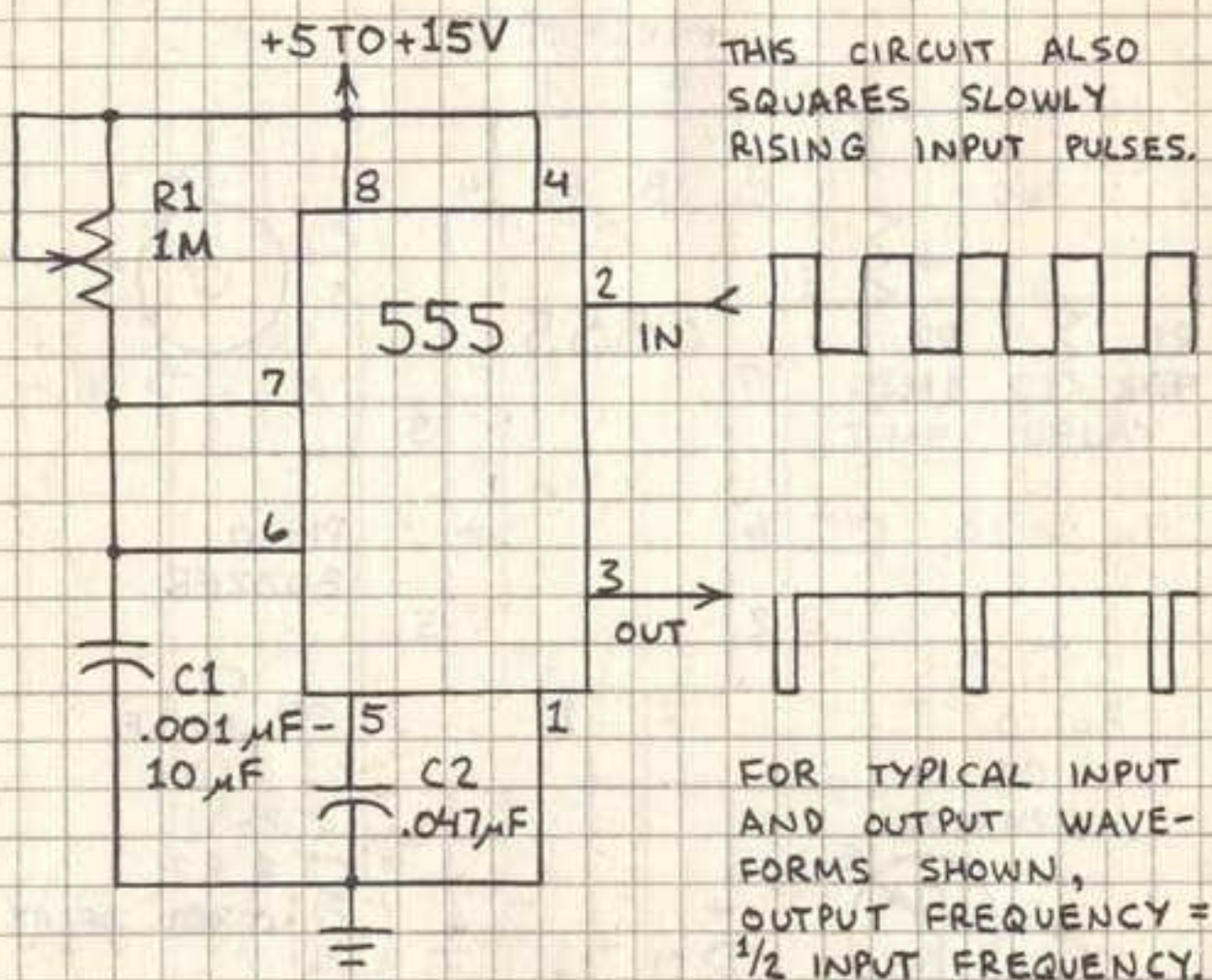

IN THIS CIRCUIT THE 555 IS CONNECTED AS A MONOSTABLE MULTIVIBRATOR. ONCE A TIMING CYCLE IS INITIATED BY AN INPUT PULSE, SUBSEQUENT INPUT PULSES HAVE NO EFFECT UNTIL CYCLE IS COMPLETED. SHOWN BELOW ARE TYPICAL INPUT AND OUTPUT WAVEFORMS ($C1 = 0.1 \mu F$, $R1$ VARIED IN VALUE).

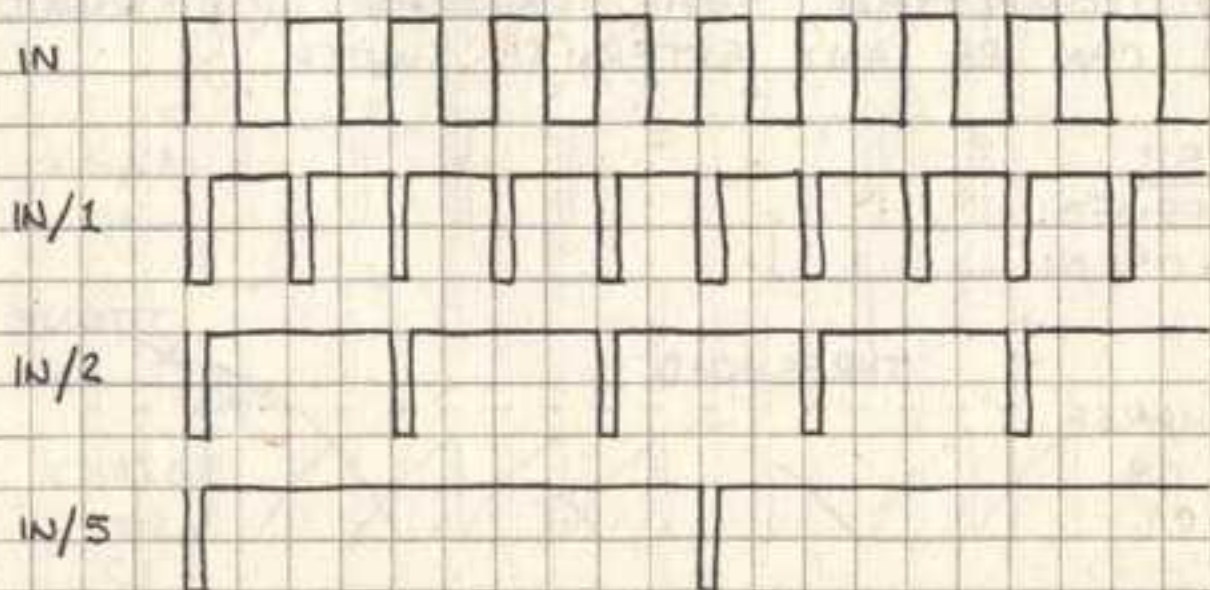

VOLTAGE-CONTROLLED OSCILLATOR

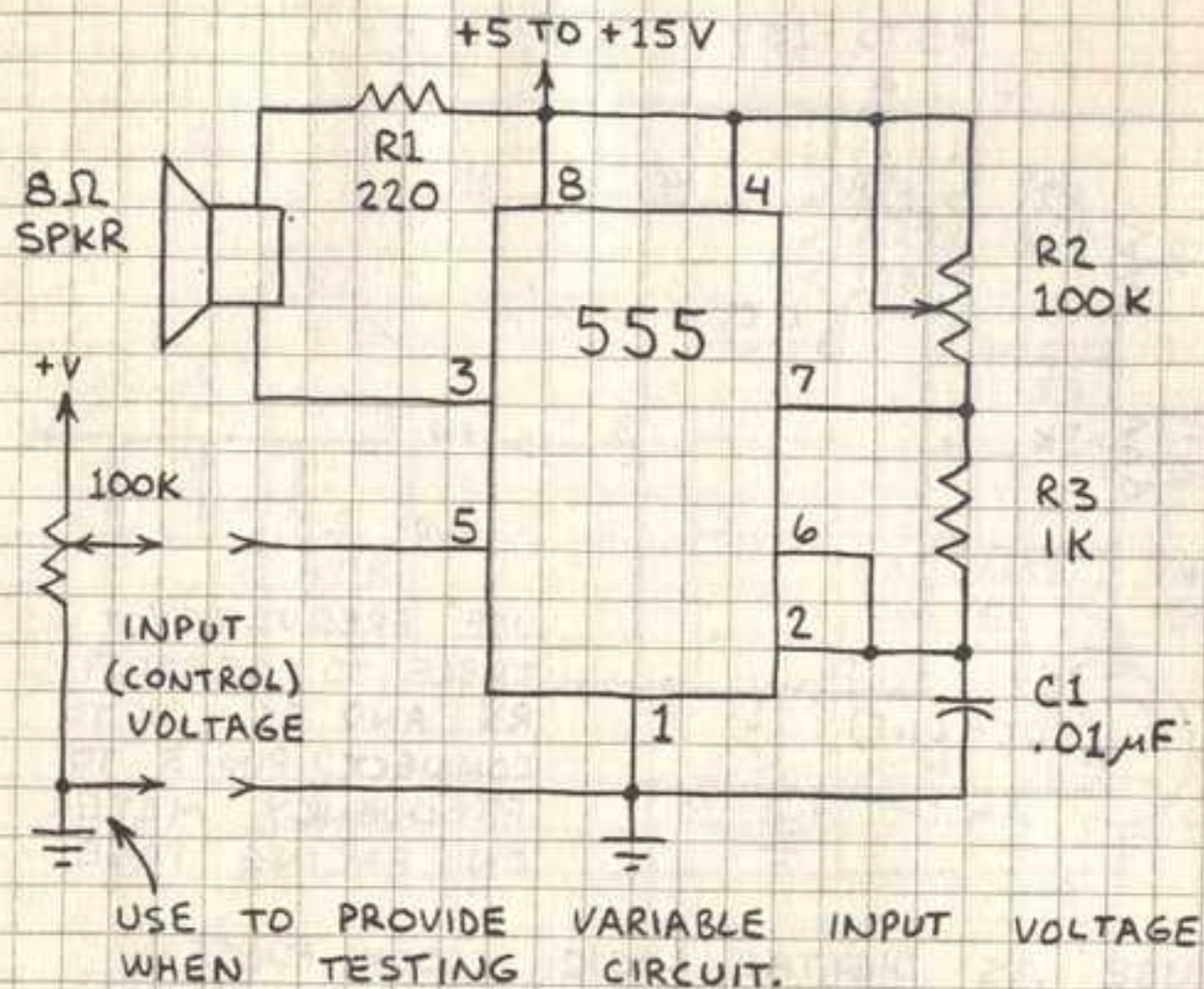

THE 555 OSCILLATES AT A FREQUENCY DETERMINED BY $R2$ AND $C1$. A VOLTAGE APPLIED TO THE INPUT CHANGES THE OSCILLATION FREQUENCY OF THE 555. AS THE INPUT VOLTAGE INCREASES, THE OSCILLATION FREQUENCY DECREASES. FOR MORE VOLUME, OMIT $R1$ AND CONNECT SPKR TO GROUND THROUGH $4.7 \mu F$ CAPACITOR.

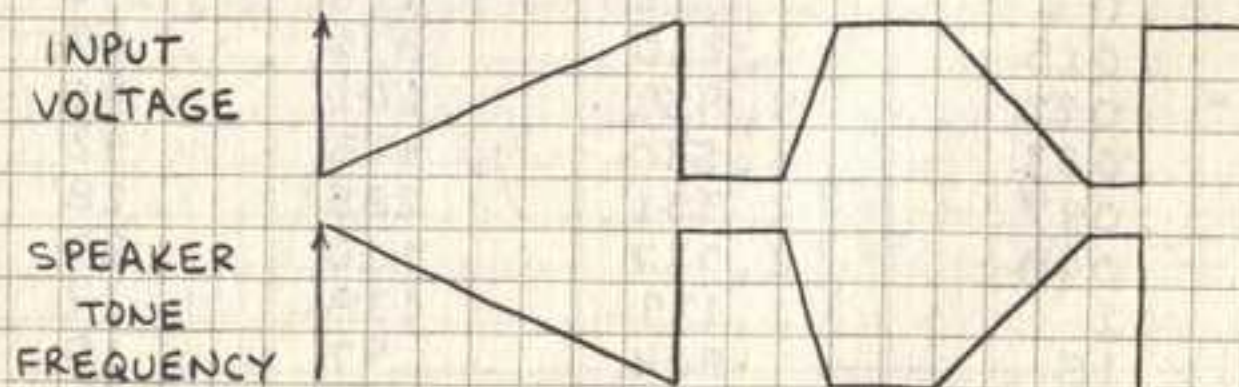

PULSE GENERATOR

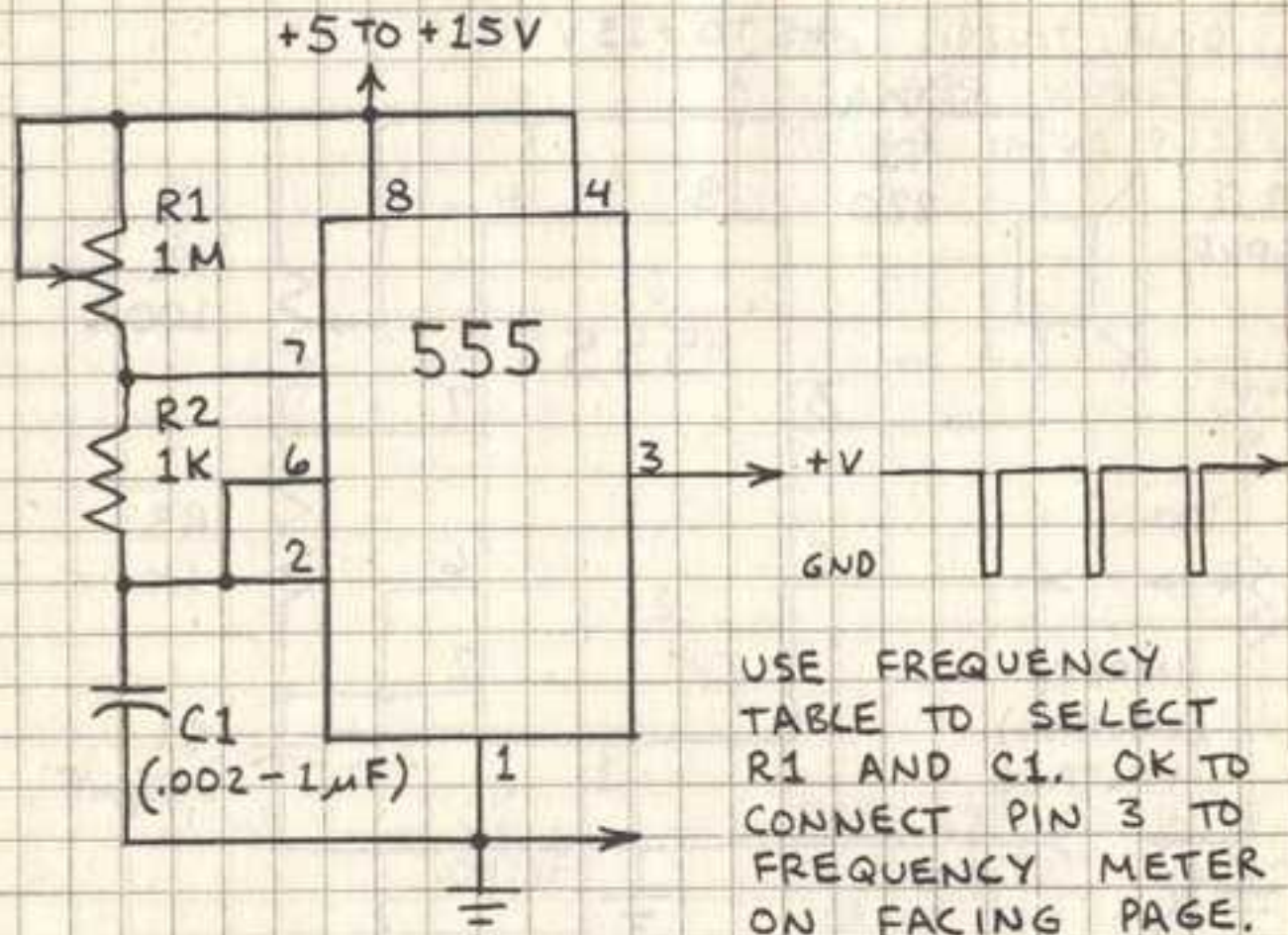

USE AS DIGITAL LOGIC CLOCK PULSE GENERATOR, SIGNAL GENERATOR, ETC.

FREQUENCY TABLE (FREQUENCIES IN Hz)

C1 (μF)	R1=10K	R1=100K	R1=1M
.0022	42,470	5,240	520
.0033	30,490	3,740	371
.0047	21,522	2,630	261
.0068	16,300	1,987	197
.01	11,622	1,414	140
.015	7,210	876	87
.022	4,959	601	60
.033	3,530	428	42
.047	2,351	285	28
.068	1,737	210	20
.1	1,139	138	14
.15	804	97	10
.22	540	65	6

FREQUENCY METER

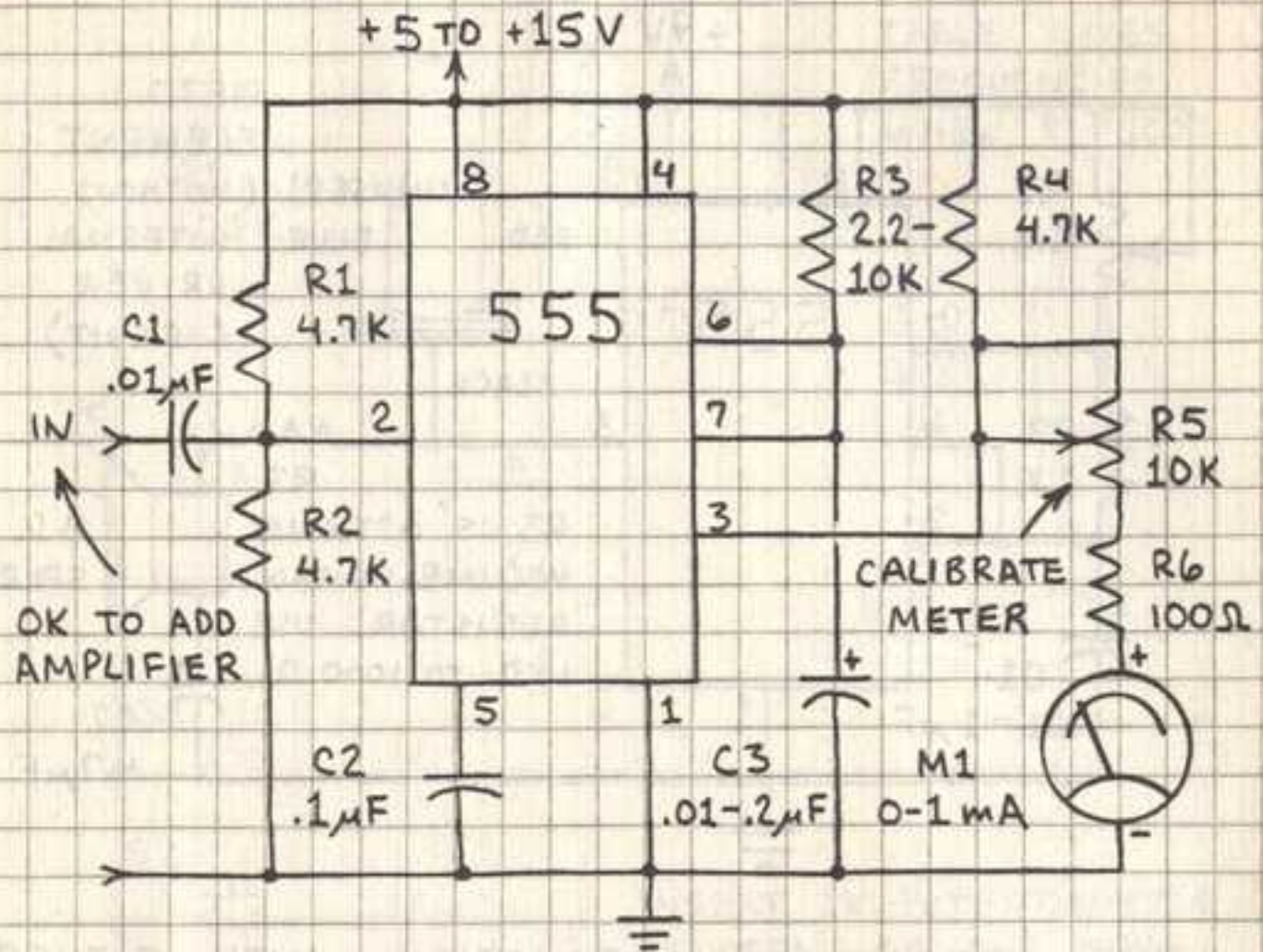

THIS ULTRA-SIMPLE CIRCUIT MEASURES AUDIO FREQUENCY SIGNALS. INPUT SIGNAL SHOULD RANGE FROM 2.5 TO 5 VOLTS. FOR TESTING, CONNECT PULSE GENERATOR ON FACING PAGE DIRECTLY TO PIN 2 (OMIT C1). R3 AND C3 DETERMINE FREQUENCY RANGE.

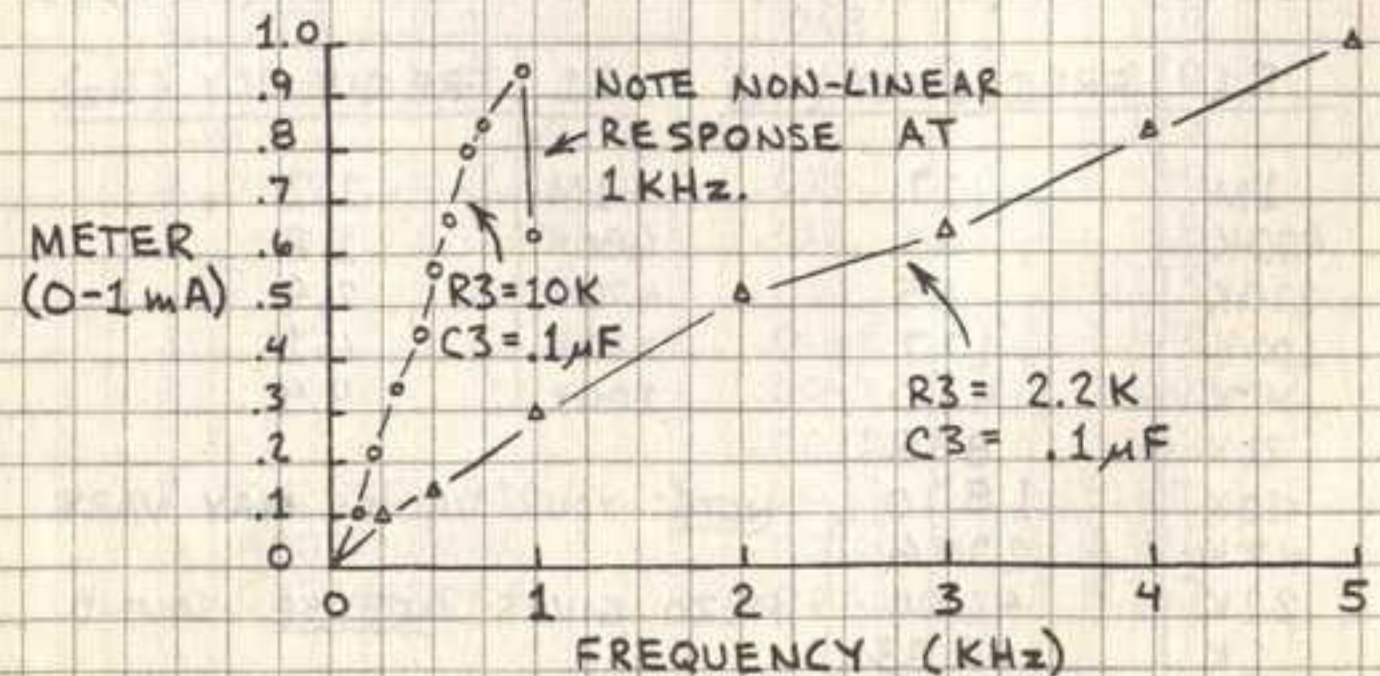

AUDIO OSCILLATOR / METRONOME

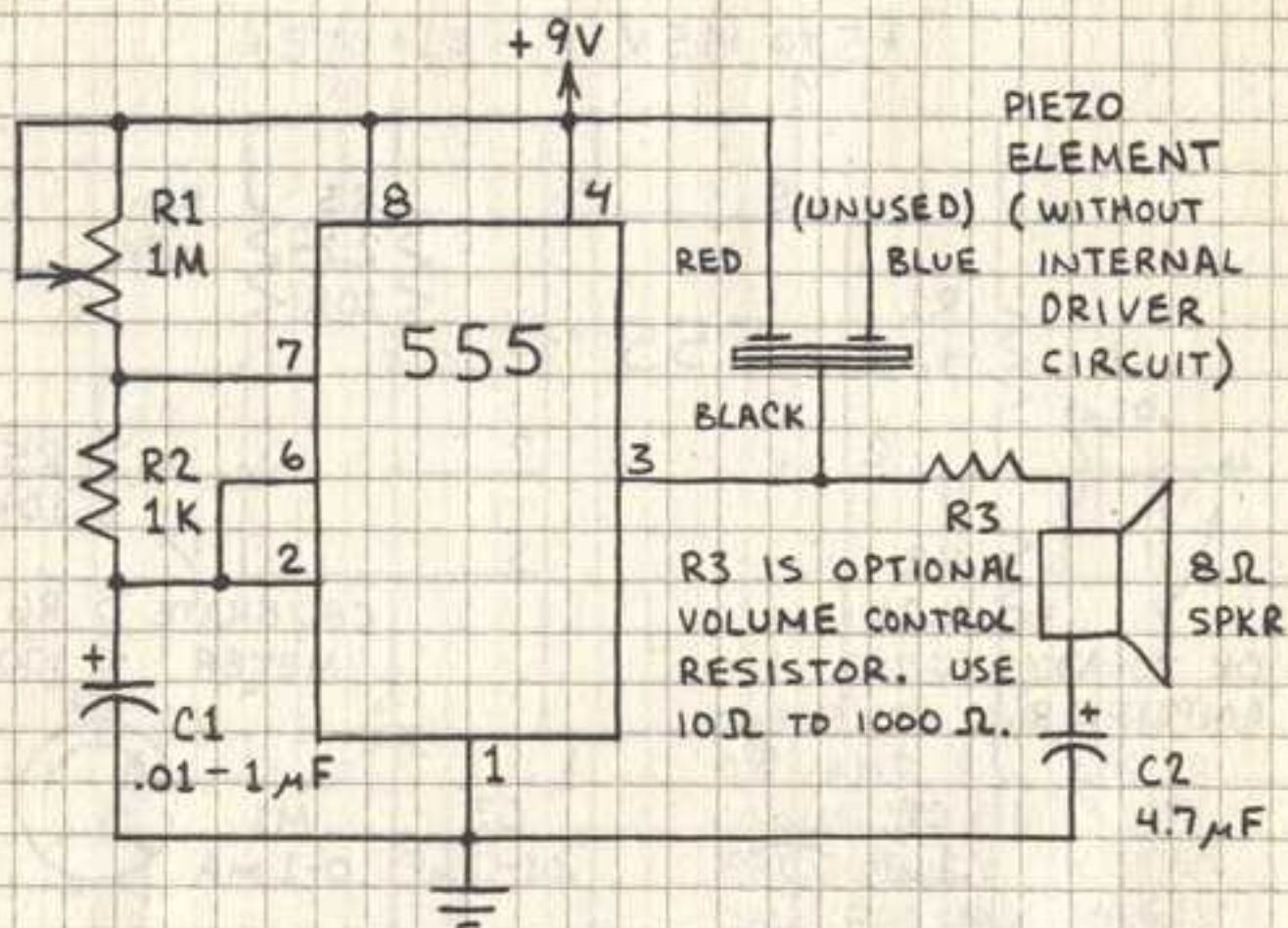

THIS CIRCUIT WILL FUNCTION WITH EITHER OR BOTH OUTPUT DEVICES. THE SPEAKER GIVES MORE VOLUME, BUT USES MORE CURRENT. USE R3 TO REDUCE VOLUME. HERE ARE TYPICAL FREQUENCIES FOR VARIOUS SETTINGS OF R1:

OSCILLATOR (C = .01 µF) METRONOME (C1 = 1 µF)

R1	FREQUENCY (Hz)	R1	FREQUENCY (Hz)
1M	17	1M	1.2
470K	40	680K	1.8
220K	85	470K	2.9
100K	177	220K	6.1
47K	410	100K	9.4
22K	838		
10K	1570		
4.7K	2746		
2.2K	4606		
1K	6283		

NOTE: YOUR VALUES MAY VARY. PIEZO GIVES INTENSE SOUND.

TOY ORGAN

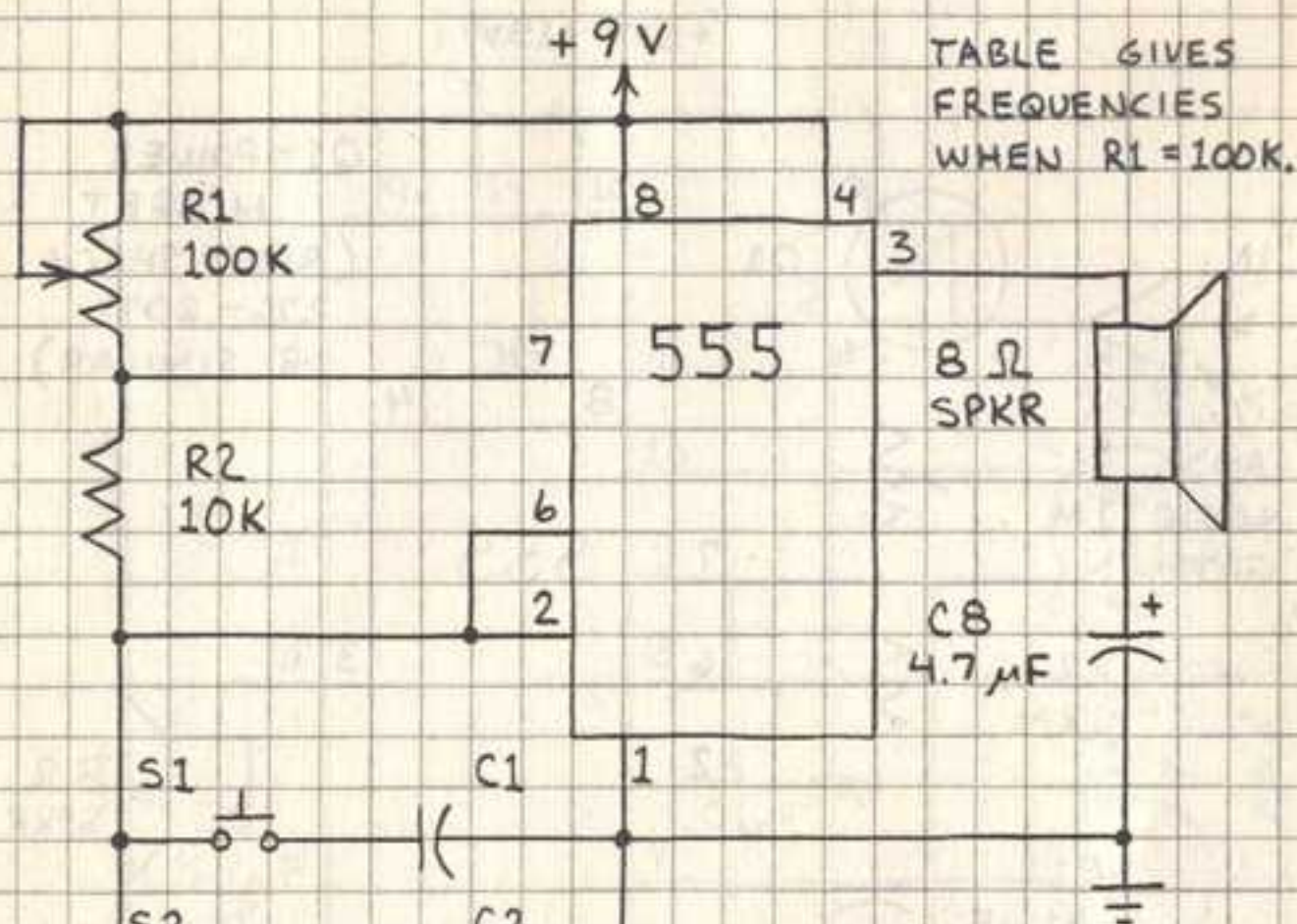

TABLE GIVES FREQUENCIES WHEN R1 = 100K.

INSERT 1K POTENTIOMETER BETWEEN C8 AND SPKR TO CONTROL VOLUME.

C (µF)	FREQUENCY (Hz)
.22	52
.15	78
.1	111
.068	170
.047	230
.033	348
.022	490
.015	718
.01	1,173
.0068	1,670
.0047	2,240
.0033	3,252
.0022	4,671
.0015	6,336
.001	9,237

OK TO ADD ADDITIONAL CAPACITORS.

GATED OSCILLATOR

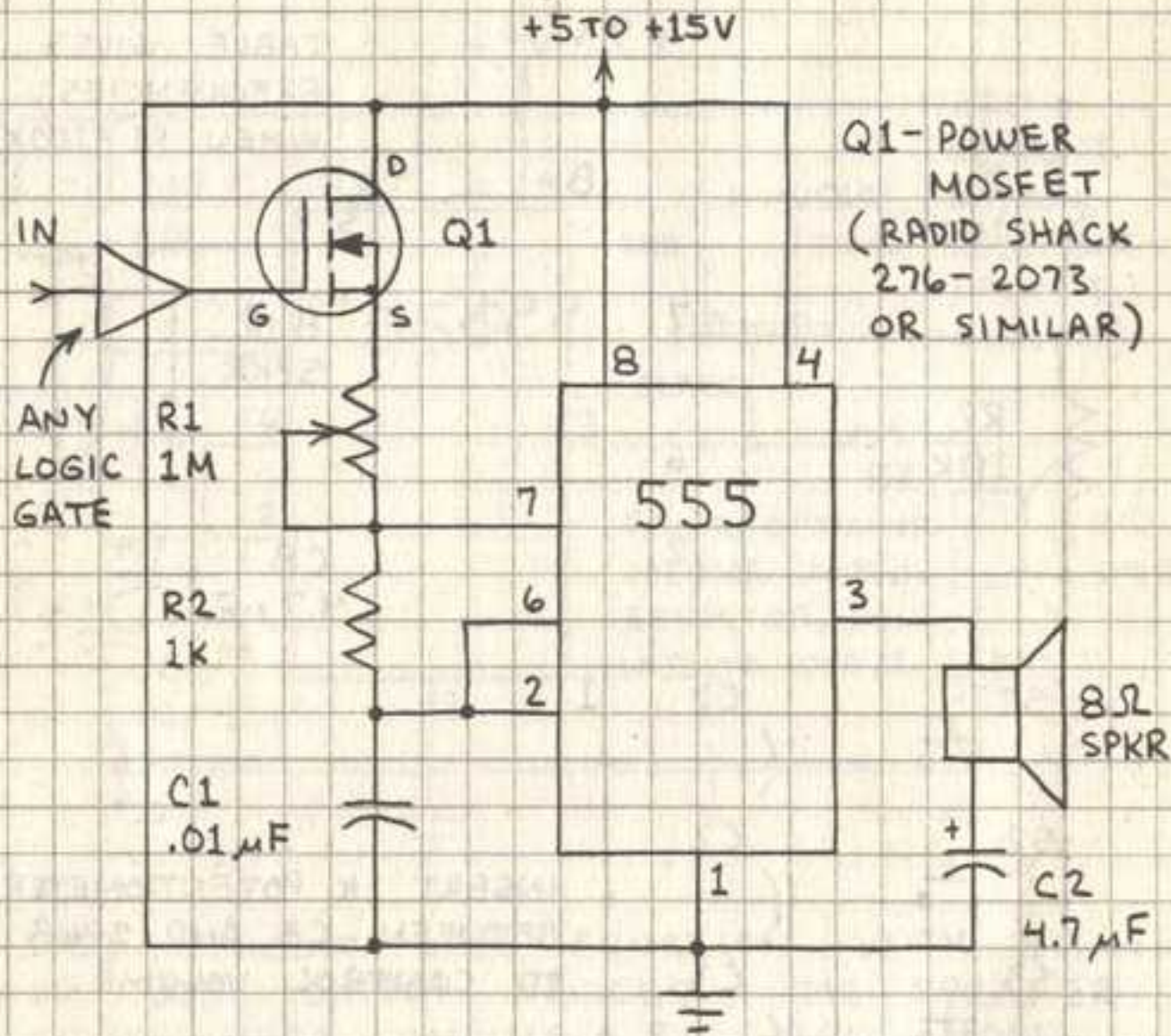

THIS CIRCUIT WILL ALLOW YOU TO SWITCH THE TONE GENERATED BY THE 555 BY MEANS OF AN EXTERNAL LOGIC SIGNAL. THE TRIANGULAR SYMBOL IS ANY EXTERNAL LOGIC GATE. OK TO SWITCH THE TONE ON AND OFF BY CONNECTING GATE OF Q1 TO +V OR GROUND THROUGH 1M RESISTOR. R1 AND C1 CONTROL TONE FREQUENCY. Q1 CAN BE CONNECTED AS A SWITCHABLE GATE ELSEWHERE IN CIRCUIT.

IN	TONE
LOW	OFF
HIGH	ON

CAUTION: Q1 CAN BE DESTROYED BY STATIC ELECTRICITY! DO NOT TOUCH EXPOSED LEADS. FOLLOW HANDLING PRECAUTIONS ON PACKAGE.

CHIRP GENERATOR

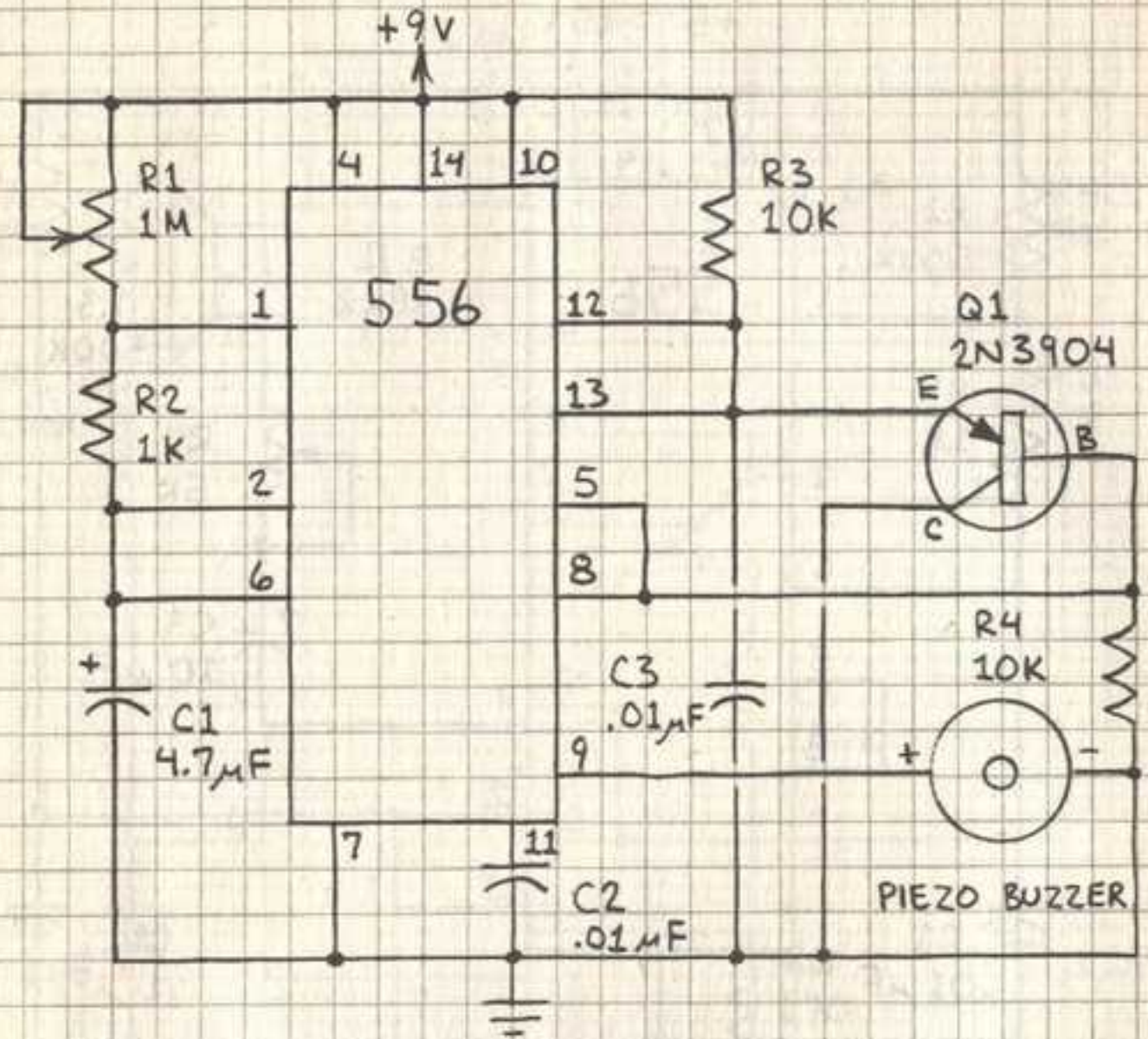

THIS CIRCUIT APPLIES BRIEF PULSES OF CURRENT TO A PIEZO BUZZER (RADIO SHACK 273-065 OR SIMILAR). THIS CAUSES THE BUZZER TO EMIT ATTENTION-GETTING CHIRPS. THE CIRCUIT MAKES A GOOD WARNING DEVICE.

R1 CONTROLS RATE OF CHIRPS. USE 100K FIXED RESISTOR FOR ABOUT 2-3 CHIRPS PER SECOND. C3 CONTROLS DURATION OF CHIRPS. FOR LONG DURATION PULSES (WHICH BECOME TONE BURSTS) INCREASE C3 TO 0.22µF OR MORE. REDUCE VOLUME BY INSERTING 100-10,000Ω RESISTOR BETWEEN PIN 9 AND PIEZO BUZZER. TRY USING CdS PHOTORESISTOR FOR R1.

STEPPED-TONE GENERATOR

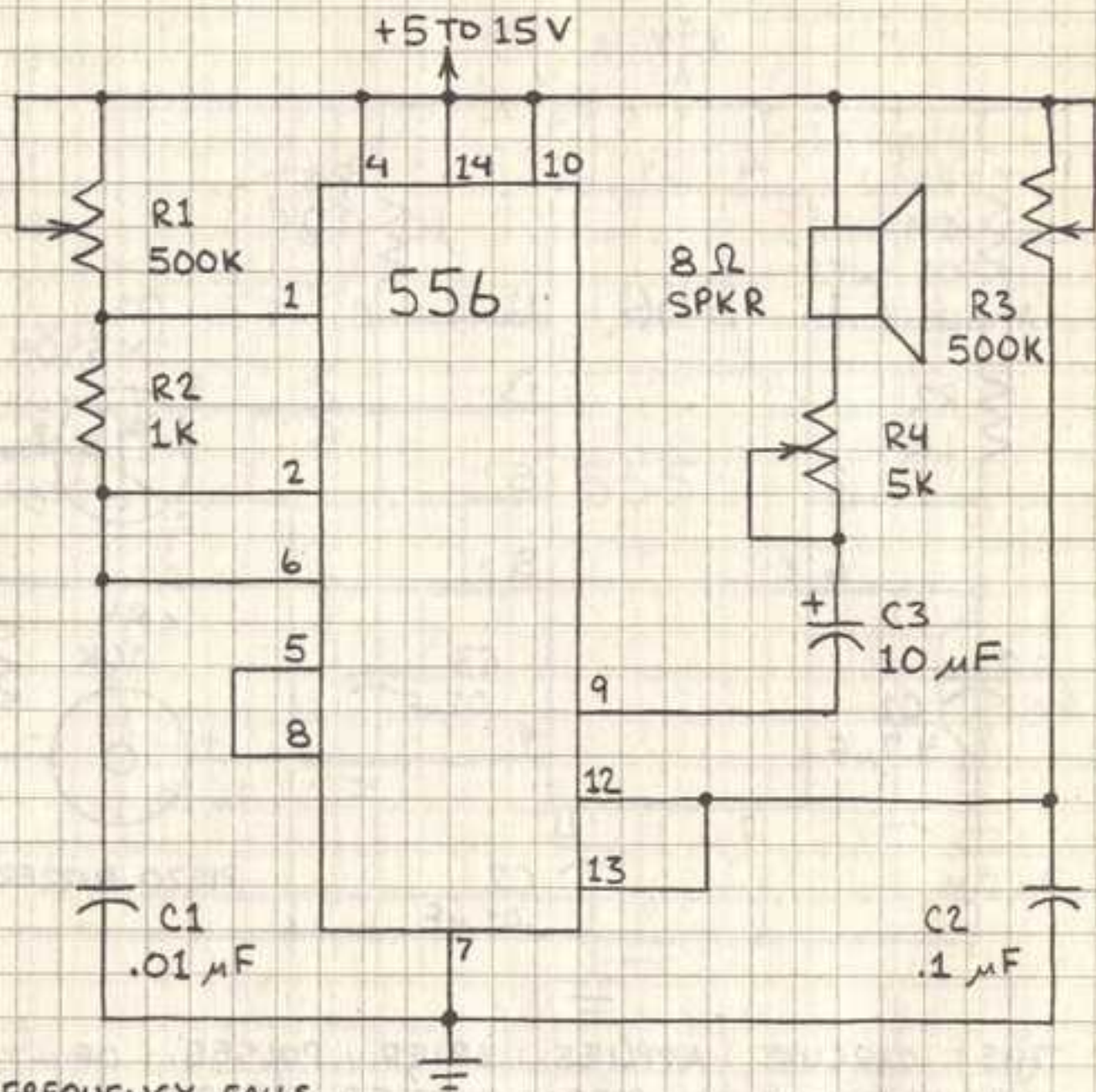

FREQUENCY FALLS AS R3 REDUCED

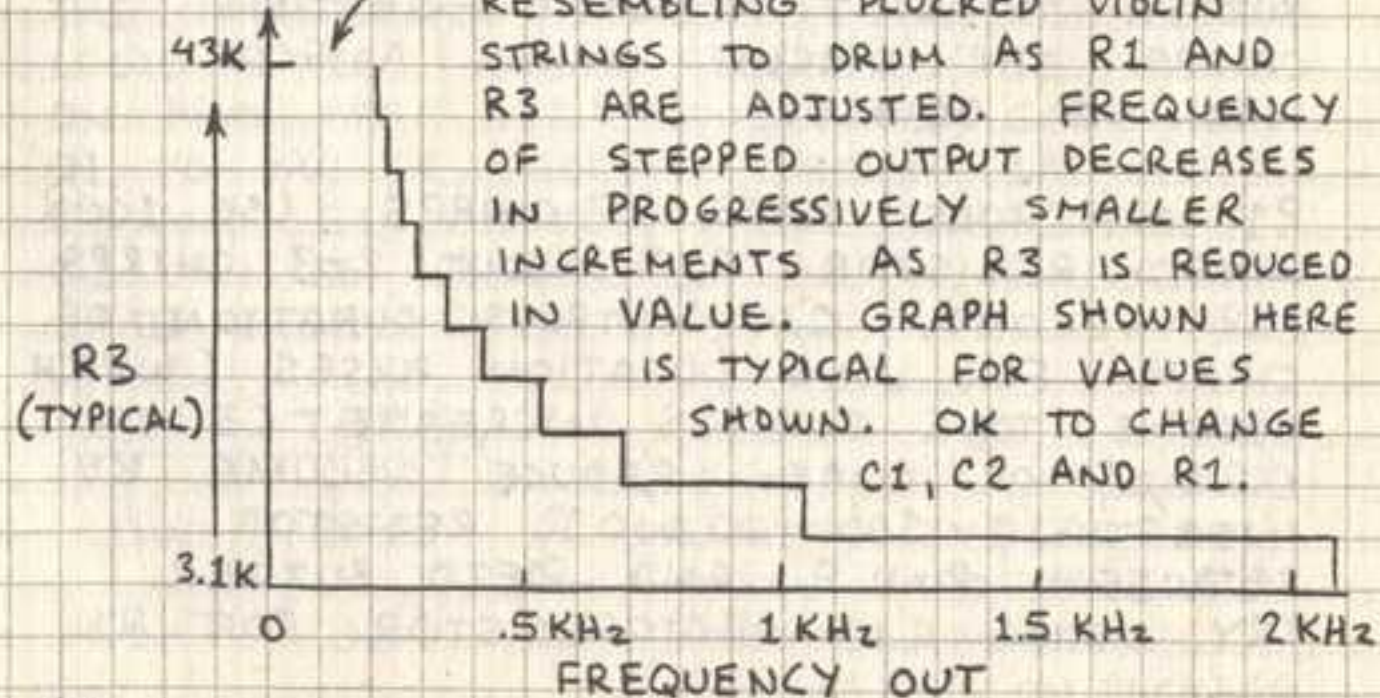

3-STATE TONE GENERATOR

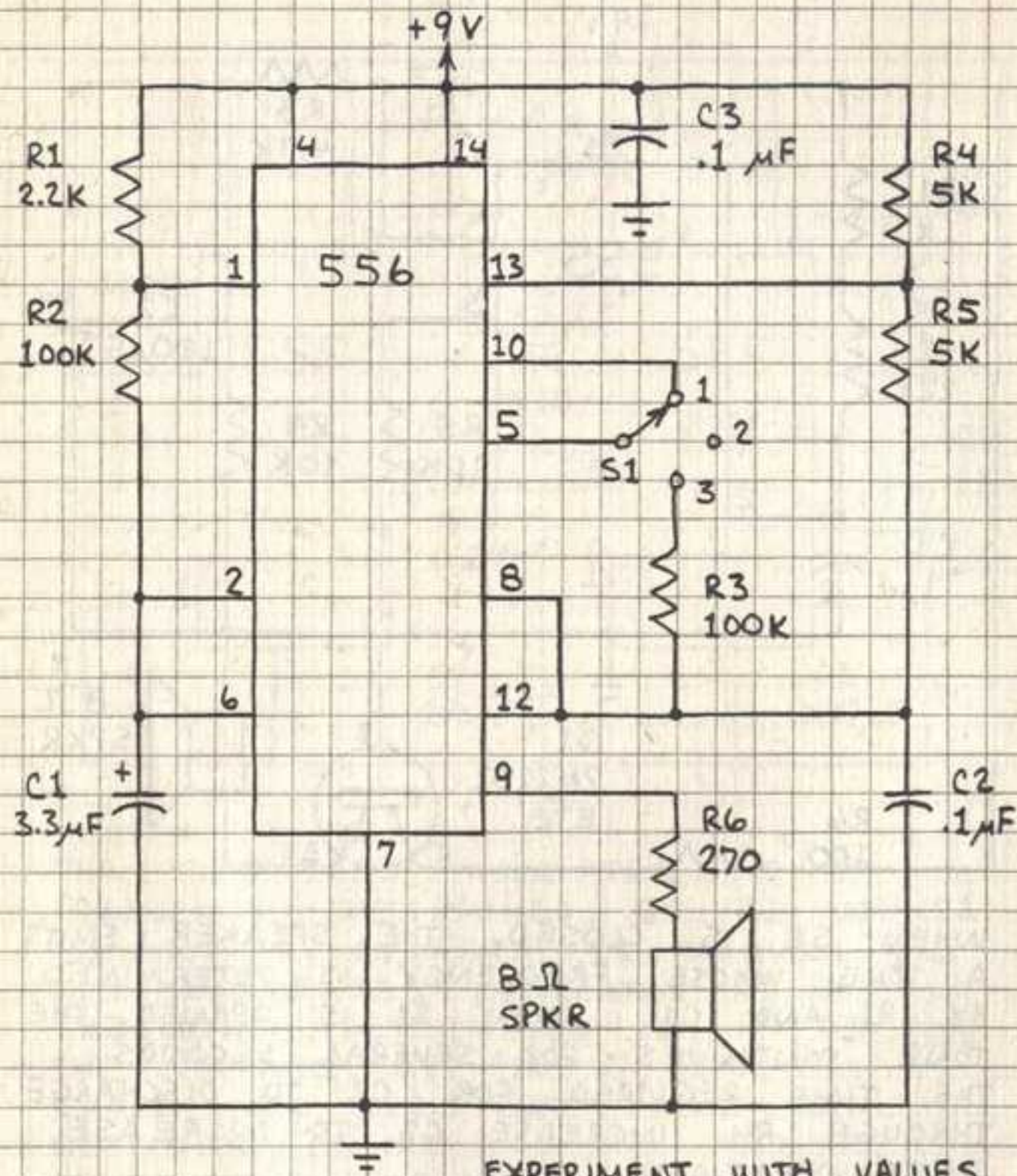

EXPERIMENT WITH VALUES OF R1, C1, R4 AND C2.

S1 (CENTER OFF):

- 1 - TONE BURST
- 2 - STEADY TONE
- 3 - TWO-TONE

TONE BURST GENERATOR

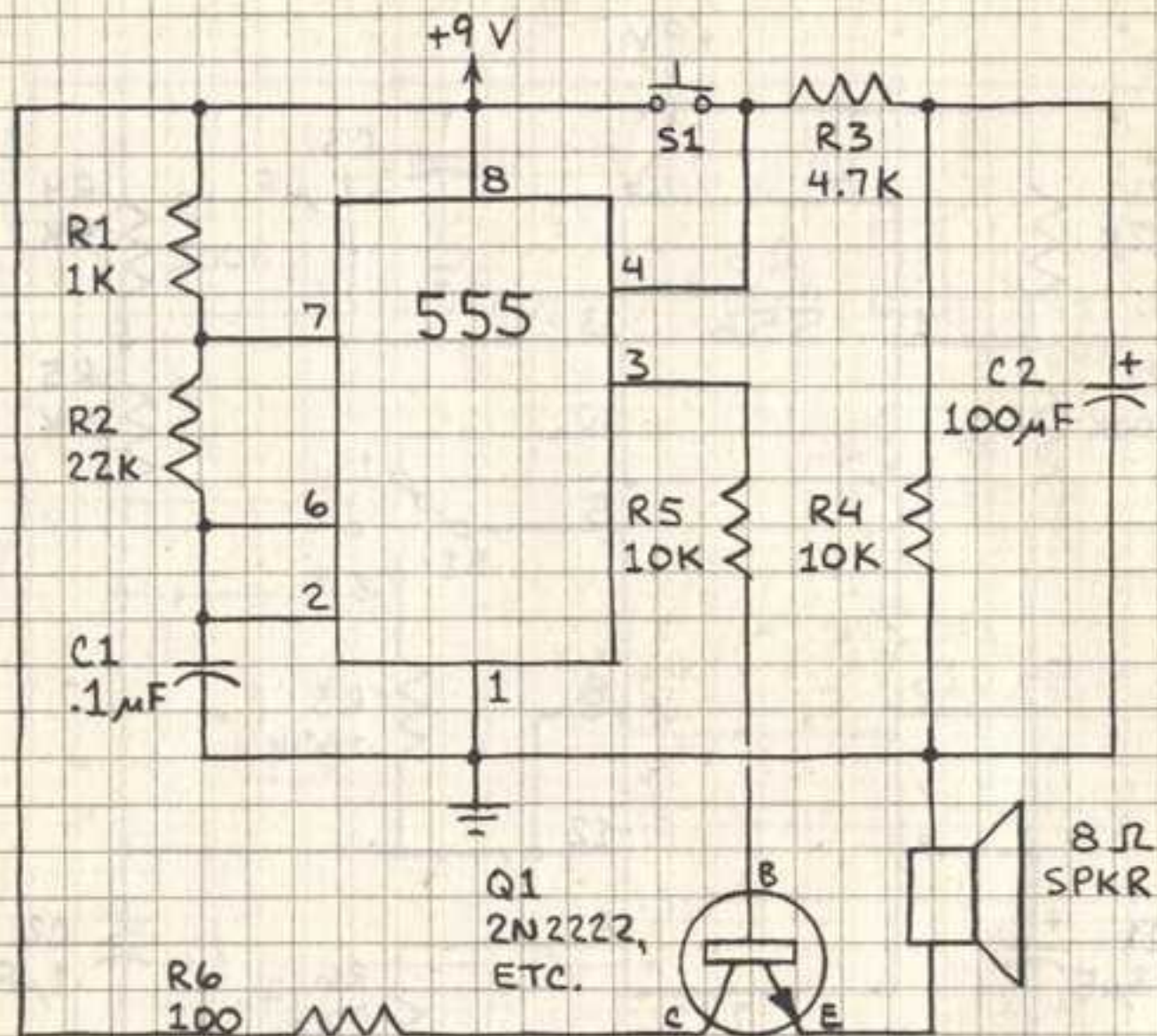

WHEN S1 IS CLOSED, THE SPEAKER EMITS A TONE WHOSE FREQUENCY IS DETERMINED BY R1 AND C1. WHEN S1 IS OPENED, THE TONE CONTINUES FOR SEVERAL SECONDS, THE TIME REQUIRED FOR C2 TO DISCHARGE THROUGH R4. INCREASE C2 TO INCREASE BURST DURATION.

CLOSE S1
OPEN S1
TONE ON
TONE OFF

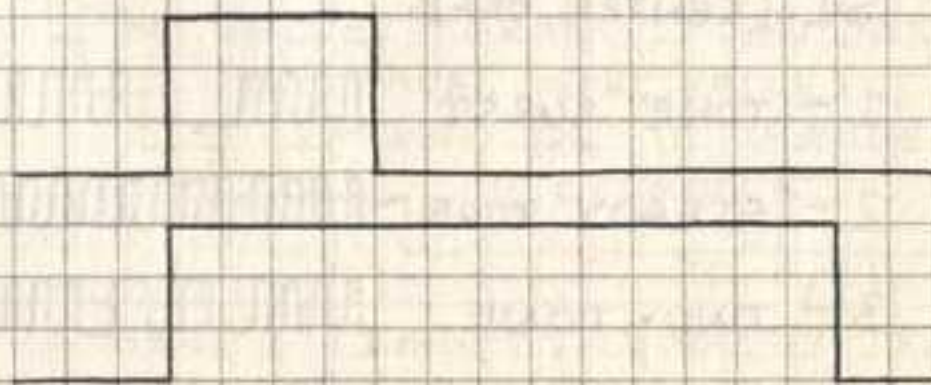

SOUND EFFECTS GENERATOR

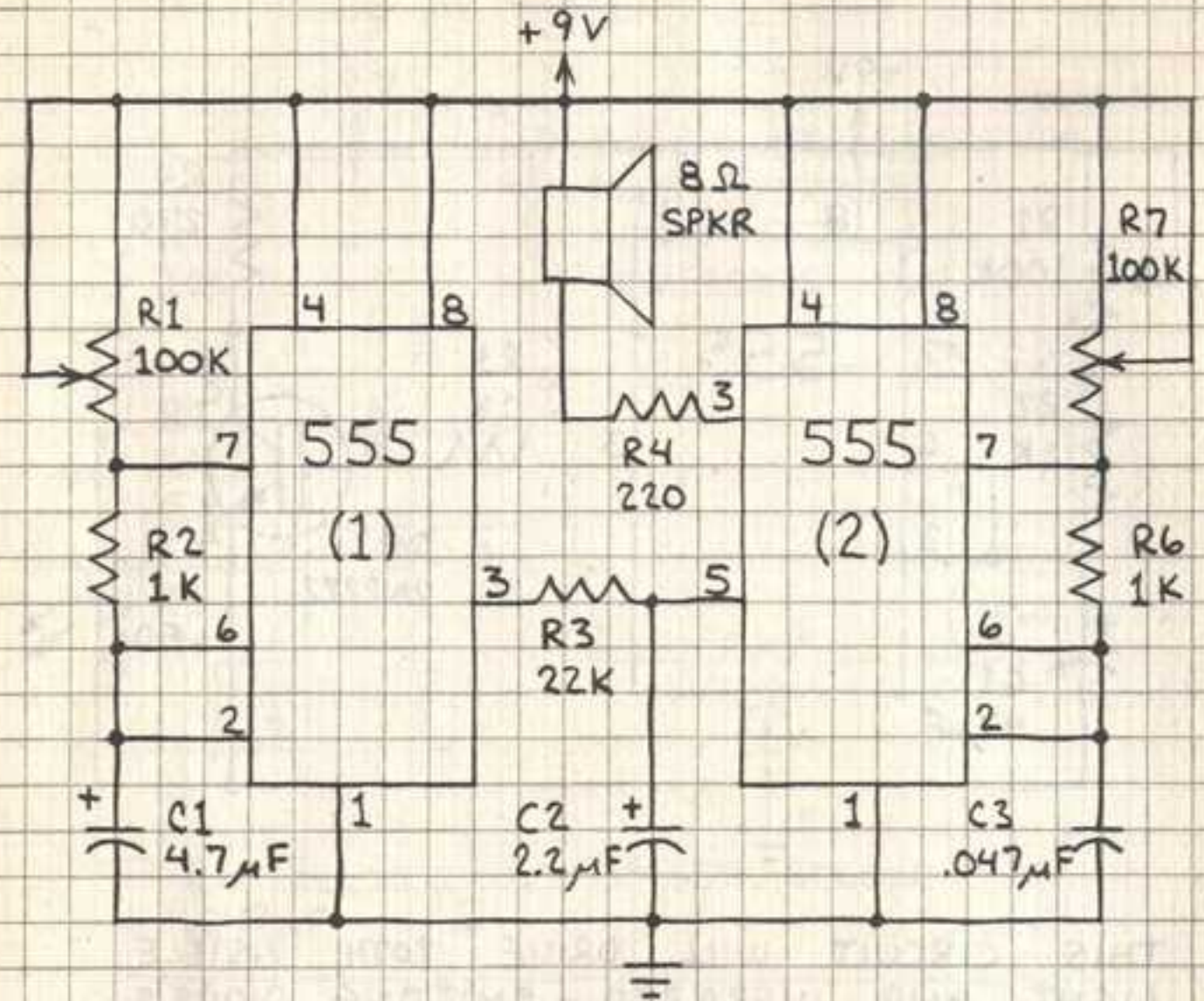

THE FIRST 555 OSCILLATES AT A FREQUENCY DETERMINED BY R1 AND C1. ITS OUTPUT CHARGES C2 THROUGH R3. THE SECOND 555 OSCILLATES AT A FREQUENCY DETERMINED BY R7, C3 AND THE VOLTAGE AT PIN 5 (i.e. THE CHARGE ON C2). EXPERIMENT WITH THE SETTINGS OF R1 AND R7 AND THE VALUES OF R3 AND C2 TO OBTAIN WARBLE EFFECTS.

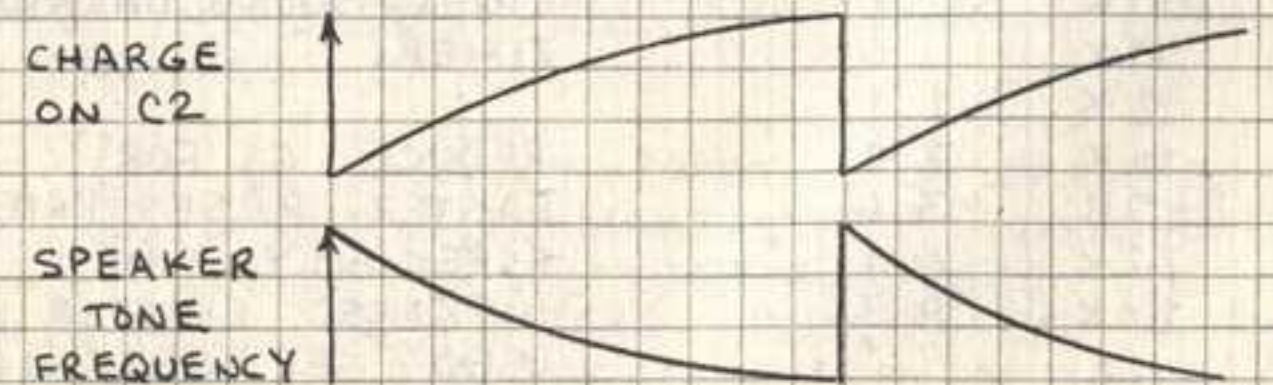

LED FLASHER

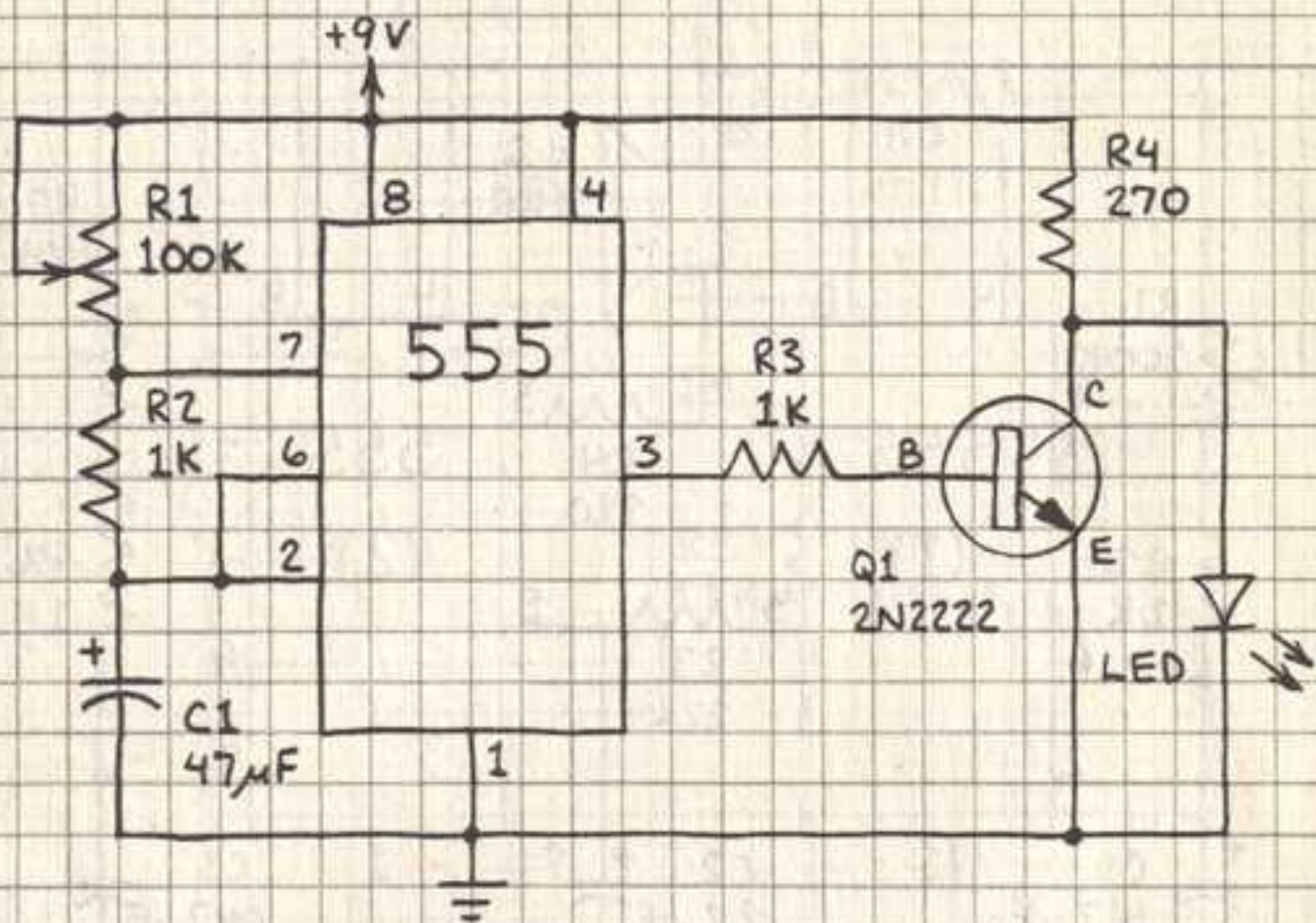

THIS CIRCUIT WILL DRIVE BOTH VISIBLE LIGHT AND INFRARED - EMITTING DIODES. USE RED, GREEN OR YELLOW LED TO MAKE A VISIBLE LIGHT FLASHER. USE NEAR-INFRARED EMITTER TO MAKE POWERFUL TRANSMITTER. CONNECT SOLAR CELL, PHOTODIODE OR PHOTOTRANSISTOR TO AMPLIFIER TO RECEIVE SIGNAL.

R1	RATE (Hz)
100 K	.2
47 K	.6
22 K	1.1
10 K	2.1
4.7 K	3.6
2.2 K	6.1
1.0 K	8.3

CONNECT PIEZO BUZZER ACROSS LED FOR LIGHT/SOUND DARKROOM TIMER.

REDUCE C1 FOR FASTER PULSE RATES, ESPECIALLY WHEN INFRARED EMITTER IS USED. SEE "GETTING STARTED IN ELECTRONICS" (RADIO SHACK, pp.66-69).

POWER FET LAMP DIMMER

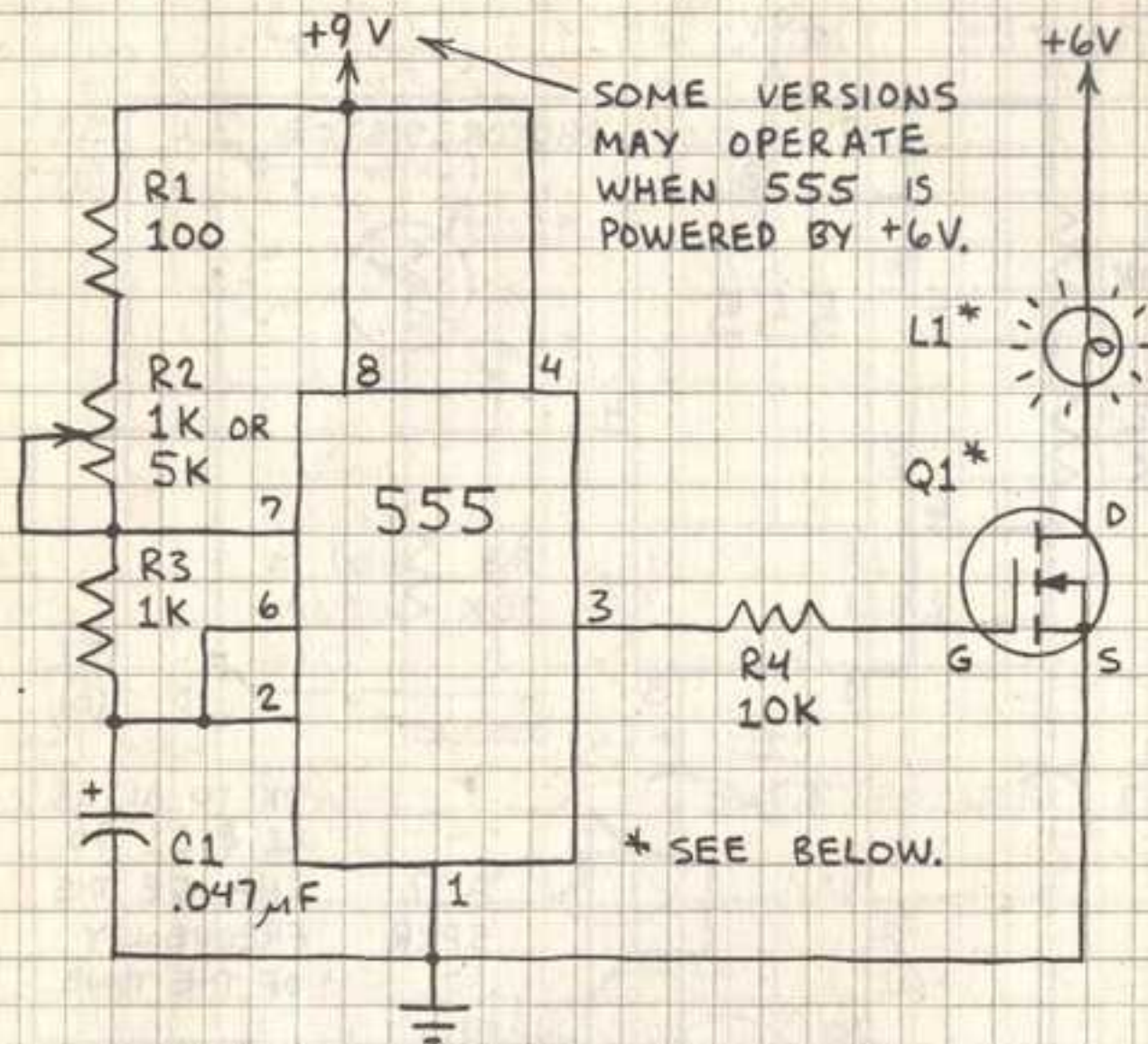

SOME VERSIONS MAY OPERATE WHEN 555 IS POWERED BY +6V.

* SEE BELOW.

THIS CIRCUIT IS A LINEAR LAMP DIMMER. IN OPERATION, THE 555 SWITCHES Q1 ON AND OFF AT A RATE DETERMINED BY $R1 + R2$ AND $C1$. WHEN Q1 IS ON, L1 IS ALSO ON. THE SWITCHING RATE IS SO FAST L1 APPEARS TO GLOW CONTINUOUSLY. INCREASING THE SWITCHING RATE INCREASES THE APPARENT BRIGHTNESS OF L1.

Q1 MUST BE PROPERLY RATED. FOR EXAMPLE, A P13 6-VOLT FLASHLIGHT LAMP CONSUMES 0.5 AMPERE OR 3 WATTS. THEREFORE USE AN IRF511 OR SIMILAR POWER FET. ATTACH A TO-220 HEATSINK TO DISSIPATE EXCESS HEAT.

LIGHT/DARK DETECTOR

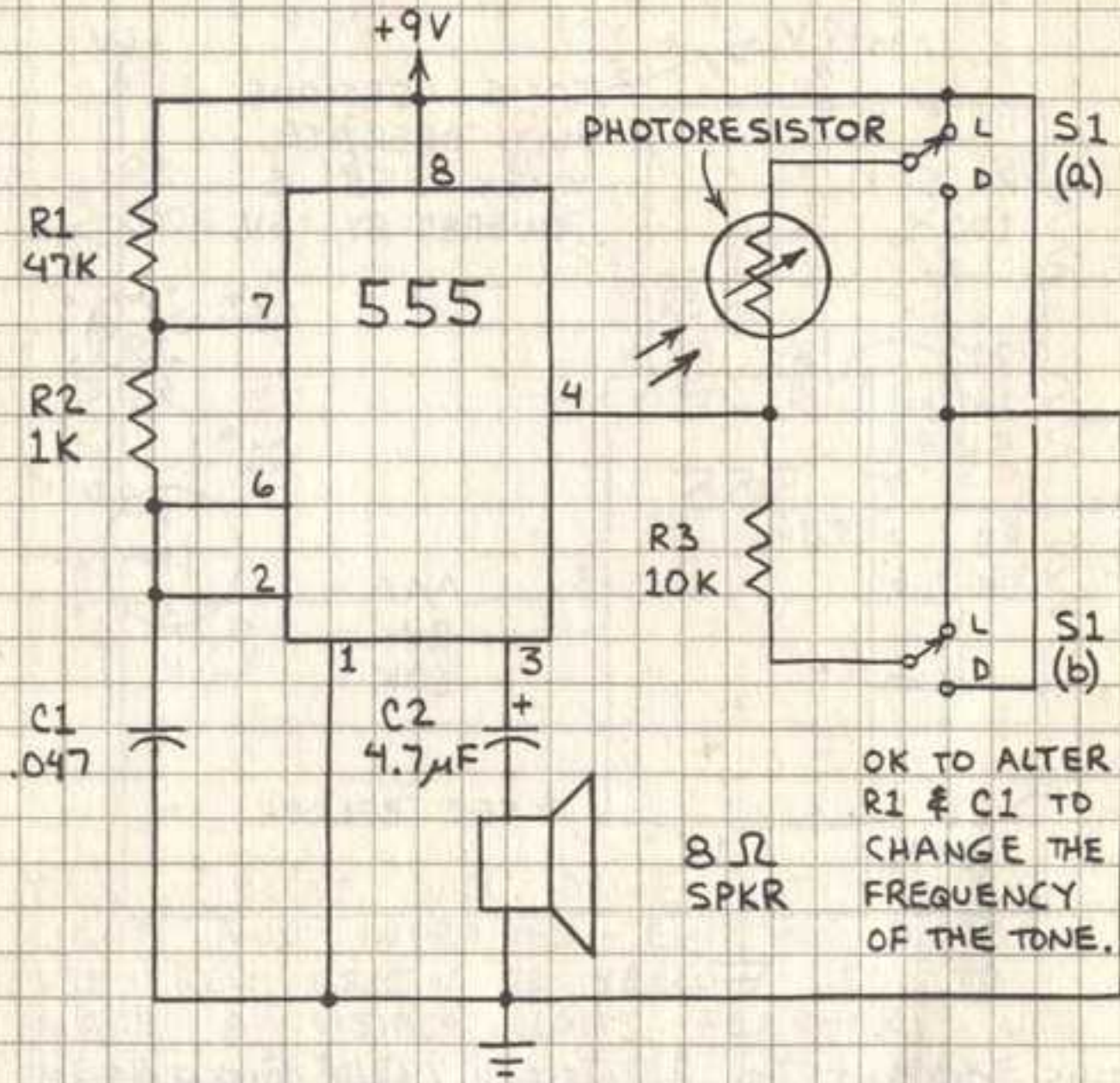

OK TO ALTER R1 & C1 TO CHANGE THE FREQUENCY OF THE TONE.

WHEN S1 IS IN POSITION "L" THE SPEAKER EMITS A TONE WHEN LIGHT STRIKES THE PHOTORESISTOR. WHEN S1 IS IN POSITION "D" THE SPEAKER EMITS A TONE WHEN THE PHOTORESISTOR IS NOT ILLUMINATED.

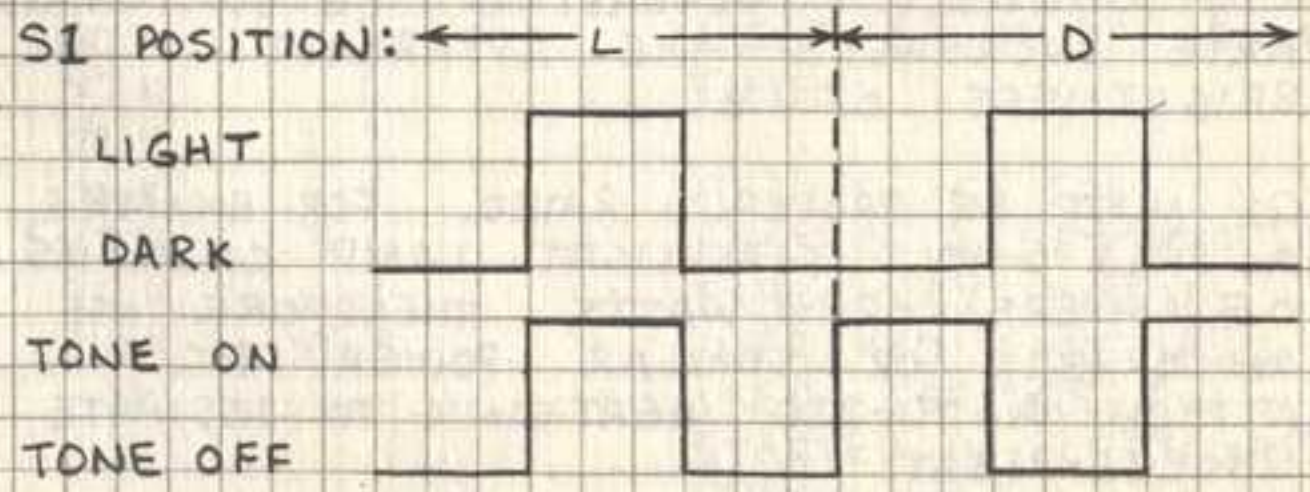

INFRARED SECURITY ALARM

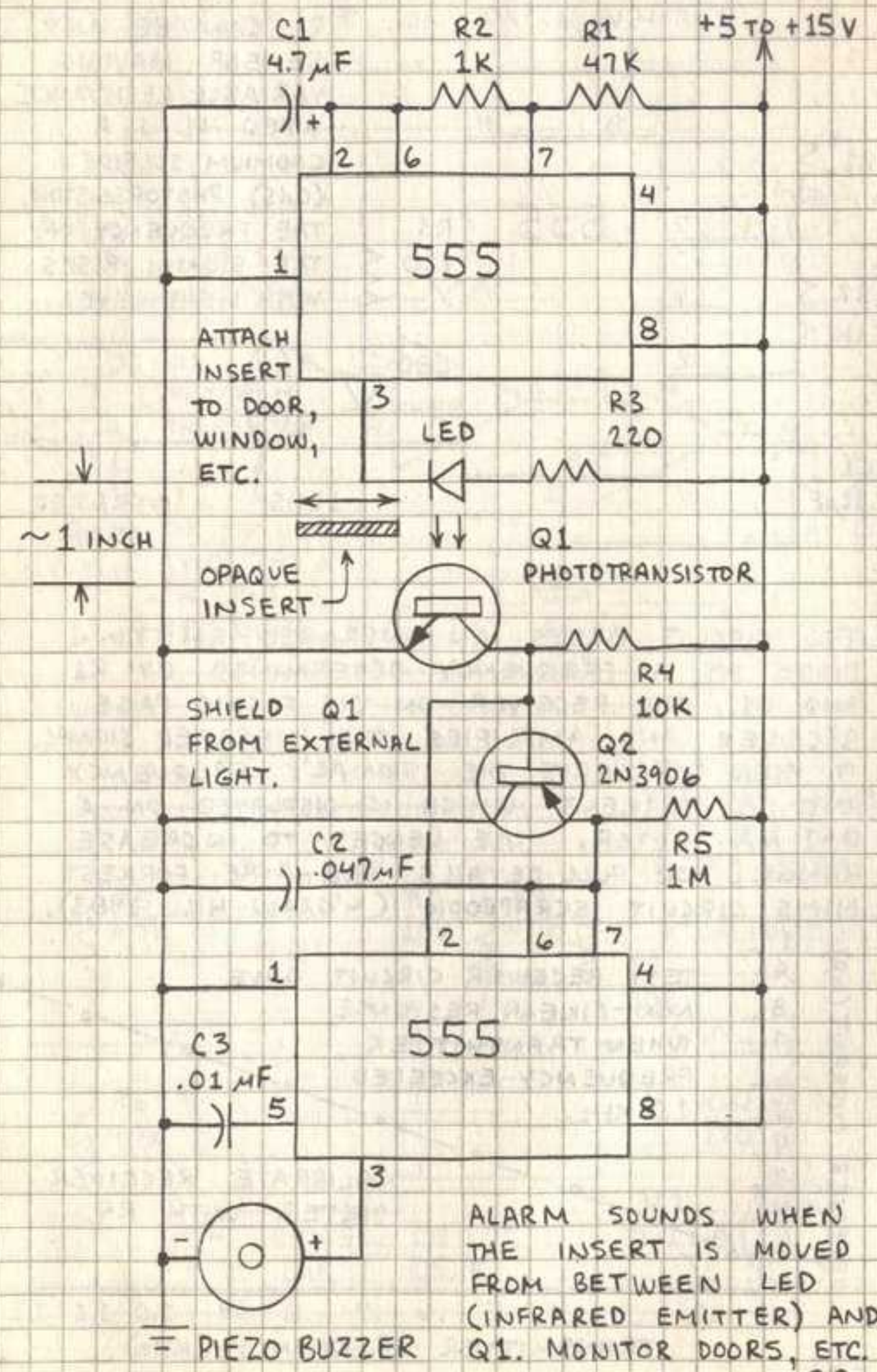

ALARM SOUNDS WHEN THE INSERT IS MOVED FROM BETWEEN LED (INFRARED EMITTER) AND Q1. MONITOR DOORS, ETC.

PIEZO BUZZER

ANALOG LIGHTWAVE TRANSMITTER

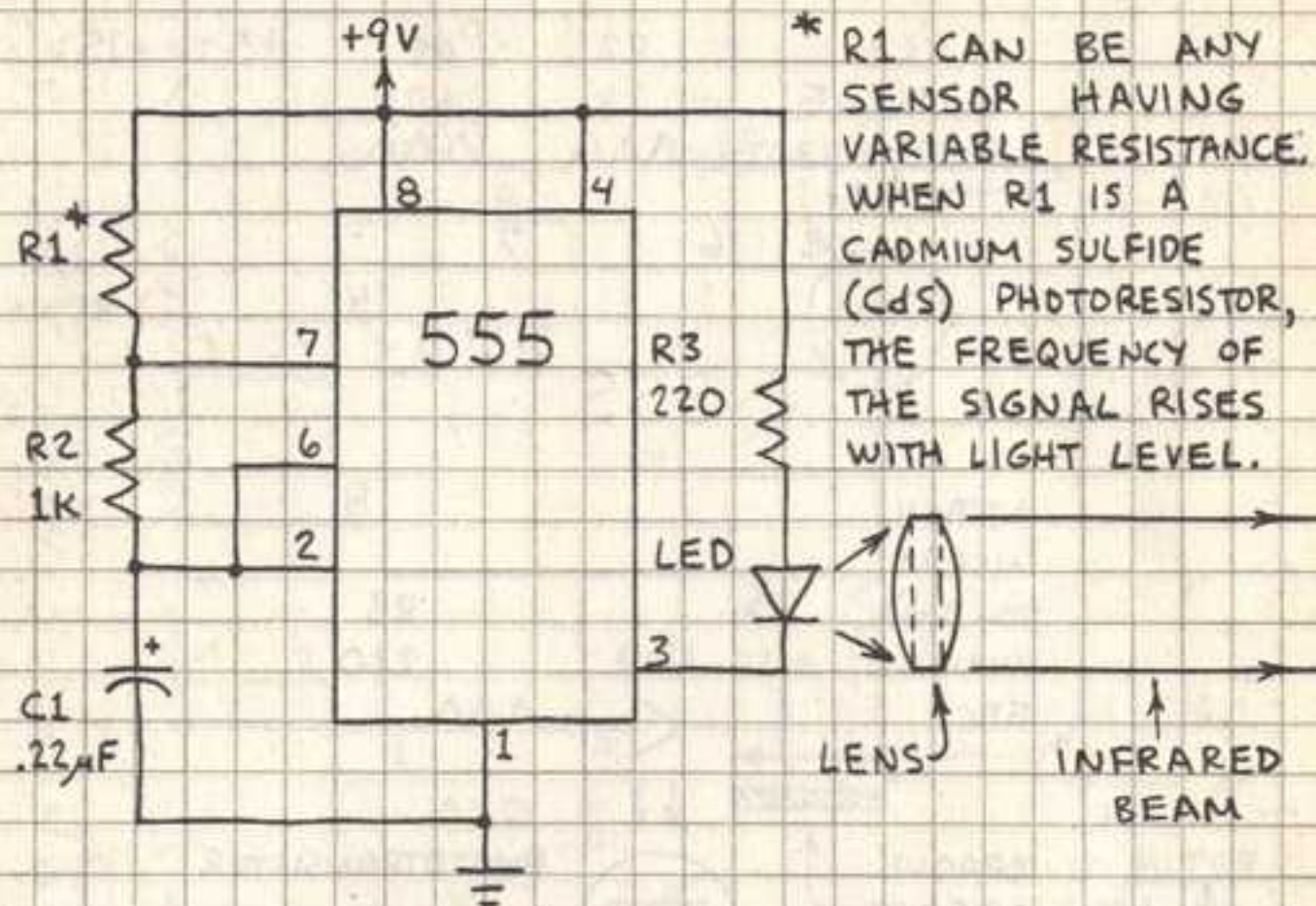

THIS CIRCUIT PULSES AN INFRARED-EMITTING DIODE AT A FREQUENCY DETERMINED BY R1 AND C1. THE RECEIVER ON THE FACING PAGE RECEIVES AND AMPLIFIES THE INFRARED SIGNAL. IT THEN CONVERTS THE SIGNAL'S FREQUENCY INTO A CURRENT WHICH IS DISPLAYED ON A 0-1 mA METER. USE LENSES TO INCREASE RANGE. FOR FULL DETAILS, SEE "THE FORREST MIMS CIRCUIT SCRAPBOOK" (M'GRAW-HILL, 1983).

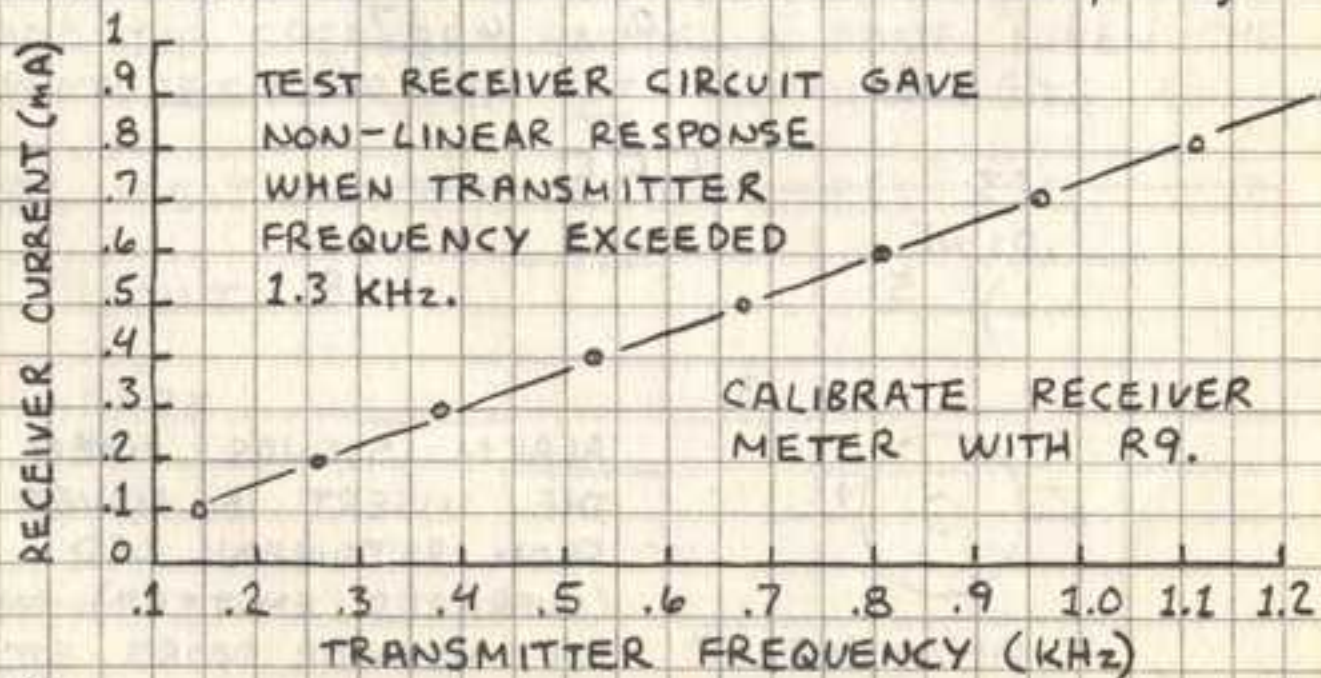

ANALOG LIGHTWAVE RECEIVER

THIS CIRCUIT RECEIVES PFM SIGNALS FROM THE TRANSMITTER ON FACING PAGE.

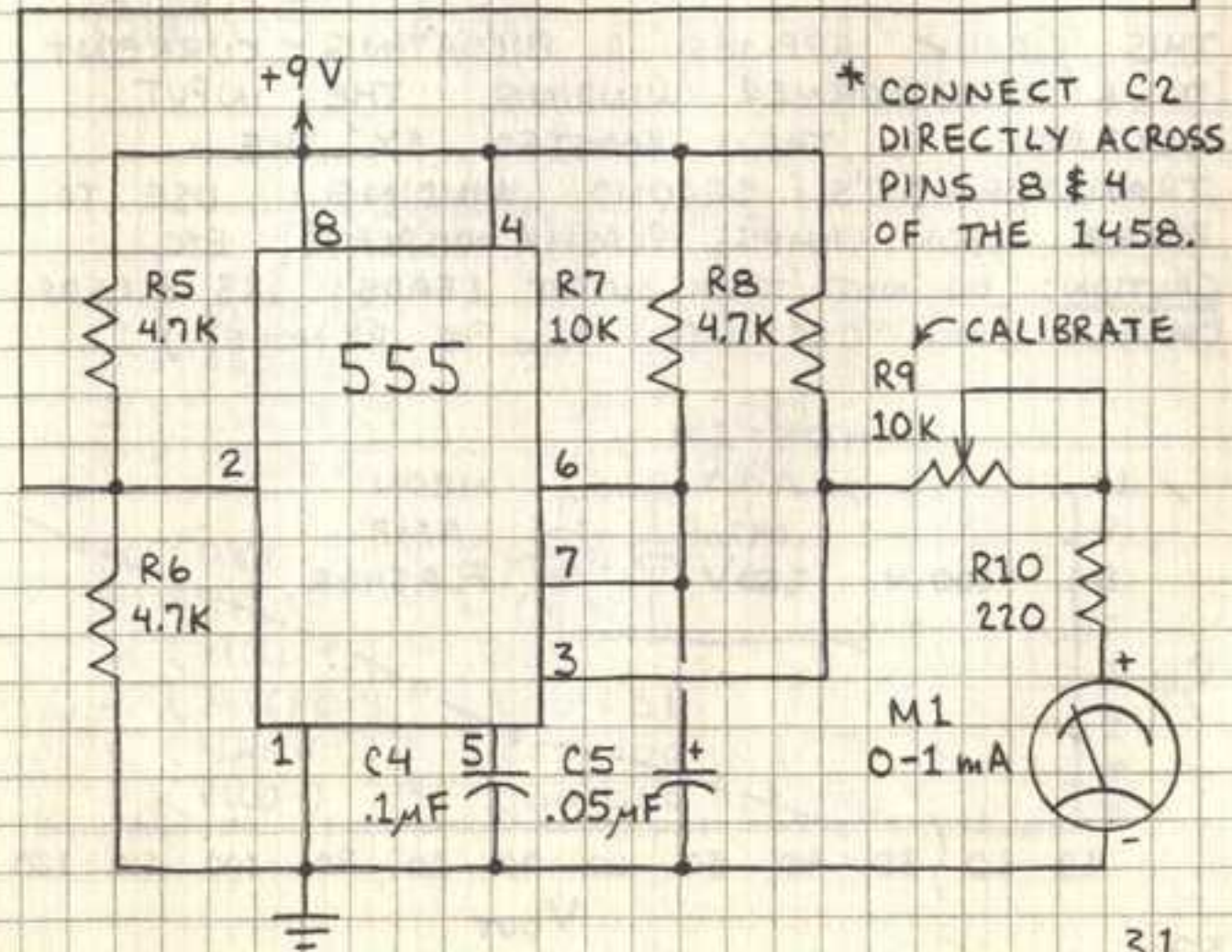
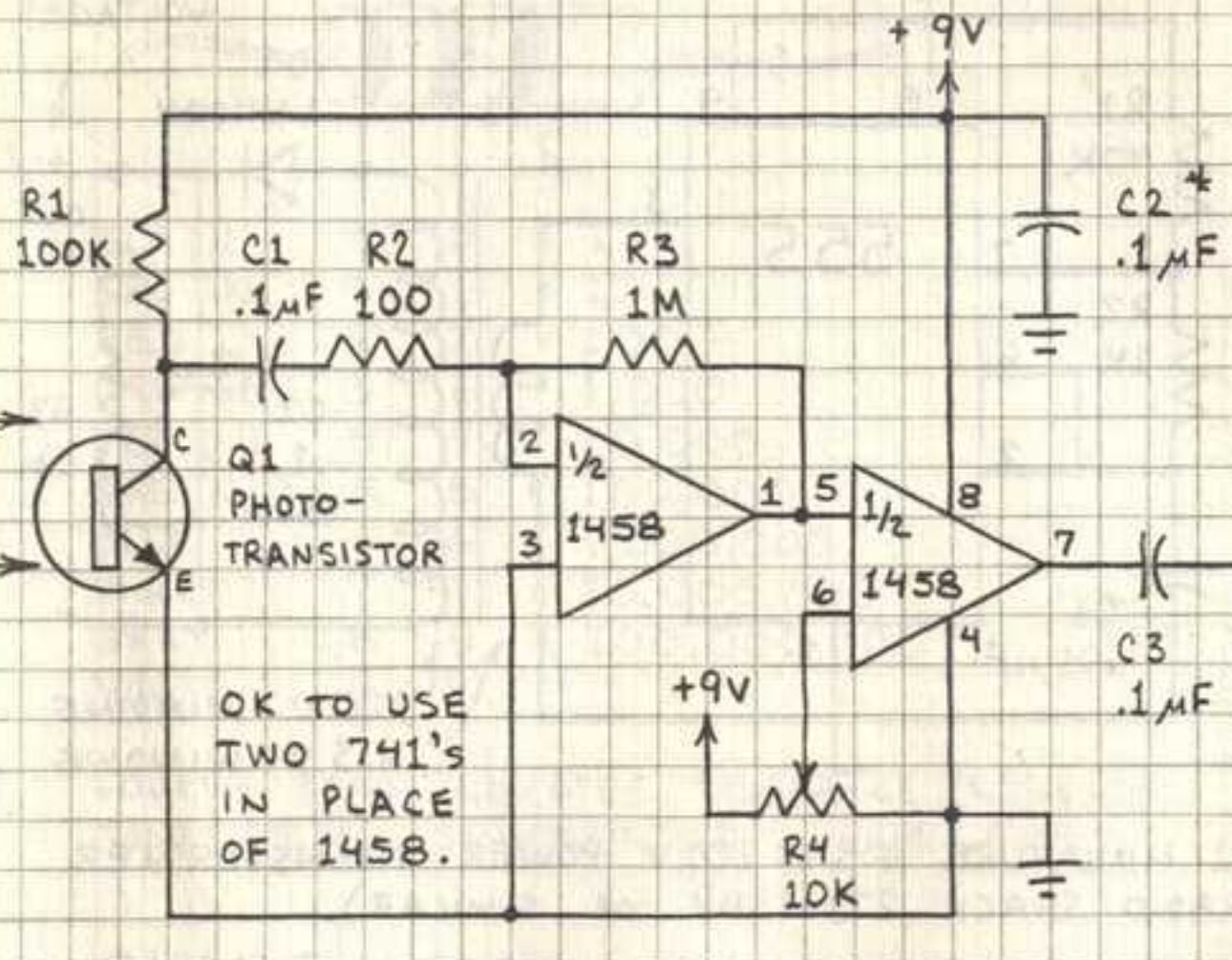

DC-DC CONVERTER

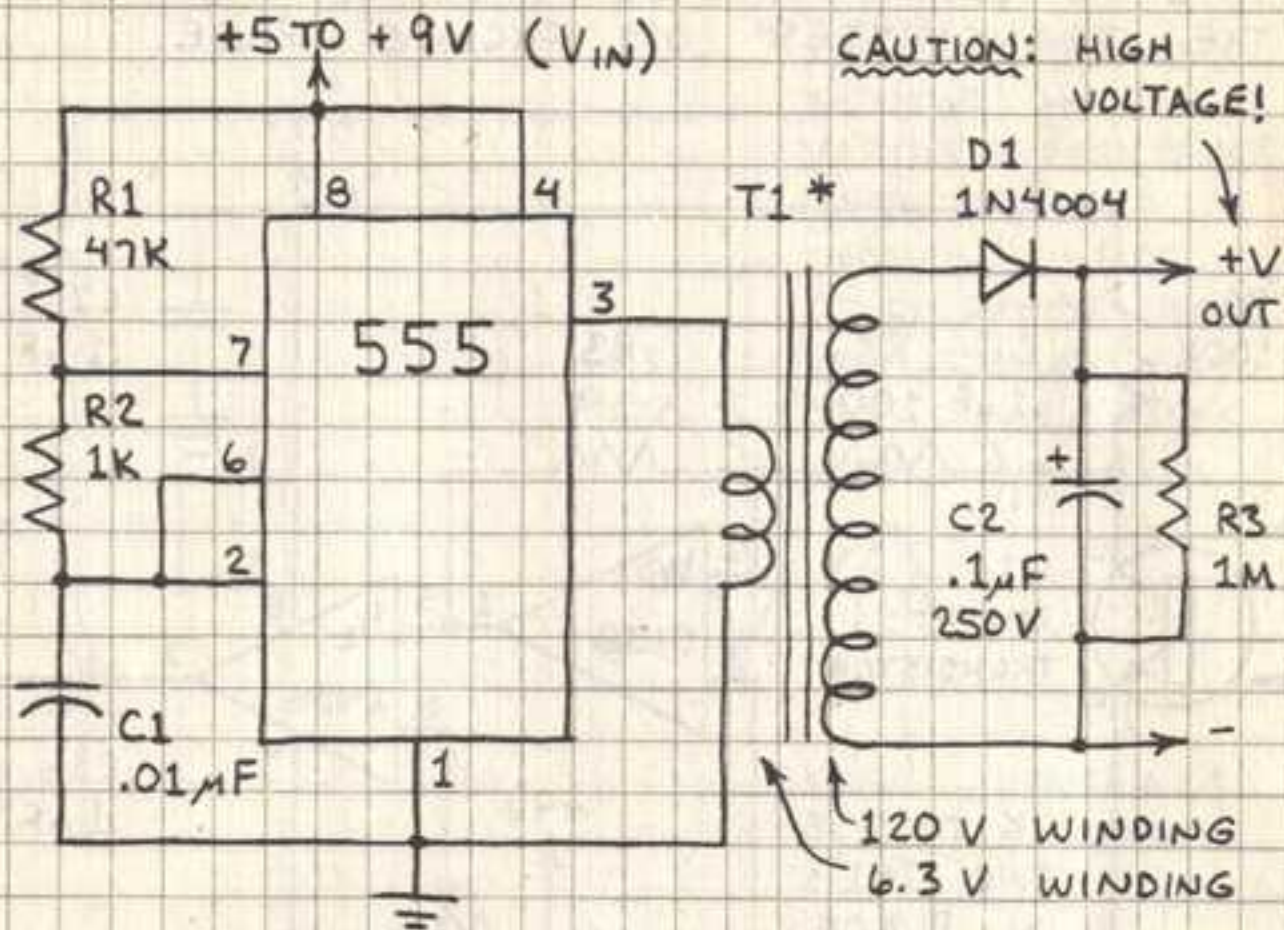

CAUTION: HIGH VOLTAGE!

*T1: MINIATURE 6.3V:120V POWER TRANSFORMER (RADIO SHACK 273-13B4 OR SIMILAR).

THIS CIRCUIT APPLIES A PULSATING CURRENT TO A TRANSFORMER WINDING. THE INPUT VOLTAGE IS THEN BOOSTED BY THE TRANSFORMER'S SECOND WINDING. USE TO POWER NEON LAMPS, PLASMA DISPLAYS, ETC.

CAUTION: DO NOT TOUCH OUTPUT LEADS! (R3 BLEEDS CHARGE FROM C2 WHEN VIN IS REMOVED.)

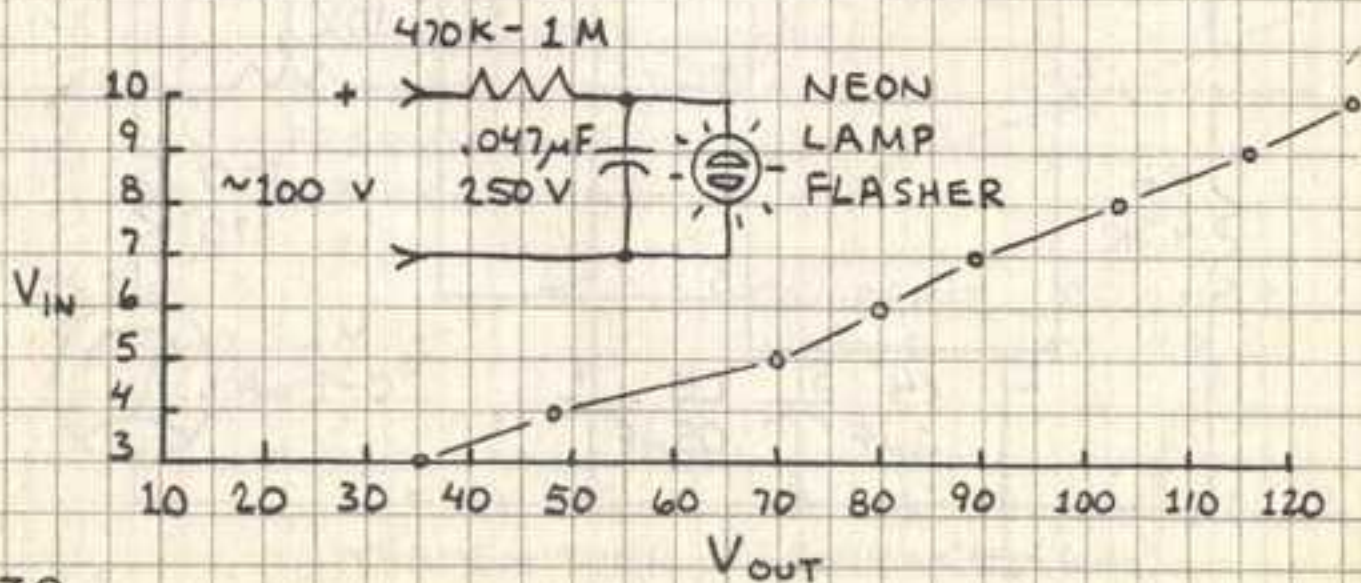

RESISTOR COLOR CODE



BLACK	0	0	x 1
BROWN	1	1	x 10
RED	2	2	x 100
ORANGE	3	3	x 1,000
YELLOW	4	4	x 10,000
GREEN	5	5	x 100,000
BLUE	6	6	x 1,000,000
VIOLET	7	7	x 10,000,000
GRAY	8	8	x 100,000,000
WHITE	9	9	—

FOURTH BAND INDICATES TOLERANCE (ACCURACY):
 GOLD = ±5% SILVER = ±10% NONE = ±20%

OHM'S LAW: $V=IR$ $R=V/I$
 $I=V/R$ $P=VI=I^2R$

ABBREVIATIONS

A = AMPERE R = RESISTANCE
 F = FARAD V (OR E) = VOLT
 I = CURRENT W = WATT
 P = POWER Ω = OHM

M (MEG-) = x 1,000,000
 K (KILO-) = x 1,000
 m (MILLI-) = .001
 µ (MICRO-) = .000 001
 n (NANO-) = .000 000 001
 p (PICO-) = .000 000 000 001